



Nanopower, 1.8V, SOT23 Comparator with Voltage Reference

FEATURES

- **LOW QUIESCENT CURRENT:** 5µA (max)
- **INTEGRATED VOLTAGE REFERENCE:** 1.242V
- **INPUT COMMON-MODE RANGE:**
200mV Beyond Rails
- **VOLTAGE REFERENCE INITIAL ACCURACY:** 1%
- **OPEN-DRAIN LOGIC COMPATIBLE OUTPUT:**
TLV3011
- **PUSH-PULL OUTPUT:** TLV3012
- **LOW-SUPPLY VOLTAGE:** 1.8V to 5.5V
- **FAST RESPONSE TIME:** 6µs Propagation Delay
with 100mV Overdrive (TLV3011: $R_{PULL-UP} = 10k\Omega$)
- **MicroSIZE PACKAGES:** SOT23-6 and SC70-6

APPLICATIONS

- **BATTERY-POWERED LEVEL DETECTION**
- **DATA ACQUISITION**
- **SYSTEM MONITORING**
- **OSCILLATORS**
- **SENSOR SYSTEMS:**
Smoke Detectors, Light Sensors, Alarms

DESCRIPTION

The TLV3011 is a low-power, open-drain output comparator; the TLV3012 is a push-pull output comparator. Both feature an uncommitted on-chip voltage reference. Both have 5µA (max) quiescent current, input common-mode range 200mV beyond the supply rails, and single-supply operation from 1.8V to 5.5V. The integrated 1.242V series voltage reference offers low 100ppm/°C (max) drift, is stable with up to 10nF capacitive load, and can provide up to 0.5mA (typ) of output current.

The TLV3011 and TLV3012 are available in the tiny SOT23-6 package for space-conservative designs. It is also available in the SC70 package for even greater board area savings. Both versions are specified for the temperature range of -40°C to +125°C.

TLV3011 and TLV3012 RELATED PRODUCTS

PRODUCT	FEATURES
TLV349x	1.2µA, 1.8V to 5.5V Push-Pull Comparator
TLV370x	560nA, 2.5V to 16V Push-Pull CMOS Output Comparator
TLV340x	550nA, 2.5V to 16V Open-Drain Comparator

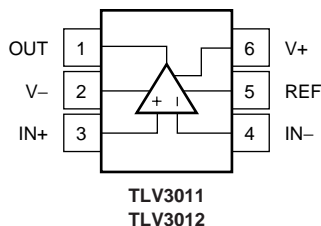

Please be aware that an important notice concerning availability, standard warranty, and use in critical applications of Texas Instruments semiconductor products and disclaimers thereto appears at the end of this data sheet.

All trademarks are the property of their respective owners.

ABSOLUTE MAXIMUM RATINGS⁽¹⁾

Supply Voltage	+7V
Signal Input Terminals, Voltage ⁽²⁾	-0.5V to (V+) + 0.5V
Current ⁽²⁾	±10mA
Output Short-Circuit ⁽³⁾	Continuous
Operating Temperature	-55°C to +150°C
Storage Temperature	-55°C to +150°C
Junction Temperature	+150°C
Lead Temperature (soldering, 10s)	+300°C
ESD Rating (Human Body Model)	2000V

NOTE: (1) Stresses above these ratings may cause permanent damage. Exposure to absolute maximum conditions for extended periods may degrade device reliability. These are stress ratings only, and functional operation of the device at these or any other conditions beyond those specified is not implied.

(2) Input terminals are diode-clamped to the power-supply rails. Input signals that can swing more than 0.5V beyond the supply rails should be current limited to 10mA or less.

(3) Short-circuit to ground.



ELECTROSTATIC DISCHARGE SENSITIVITY

This integrated circuit can be damaged by ESD. Texas Instruments recommends that all integrated circuits be handled with appropriate precautions. Failure to observe proper handling and installation procedures can cause damage.

ESD damage can range from subtle performance degradation to complete device failure. Precision integrated circuits may be more susceptible to damage because very small parametric changes could cause the device not to meet its published specifications.

PACKAGE/ORDERING INFORMATION

For the most current package and ordering information, see the Package Option Addendum located at the end of this data sheet.

PIN CONFIGURATIONS

Top View

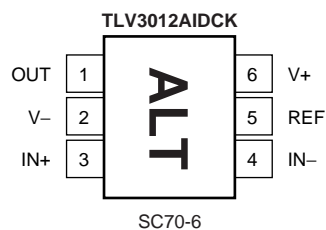
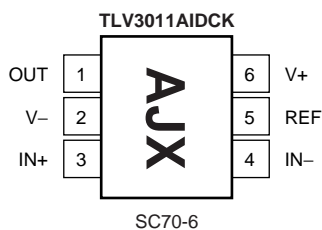
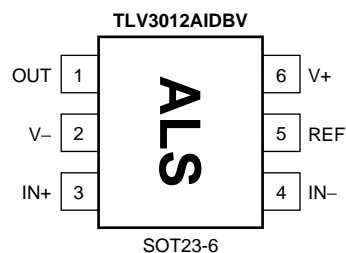
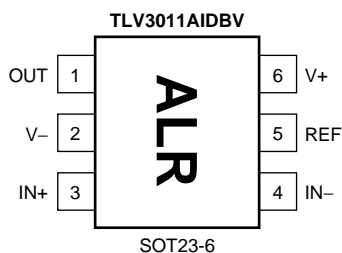

NOTE: Pin 1 is determined by orienting package marking as shown.

ELECTRICAL CHARACTERISTICS: $V_S = +1.8V$ to $+5.5V$

Boldface limits apply over the specified temperature range, $T_A = -40^{\circ}C$ to $+125^{\circ}C$.

At $T_A = +25^{\circ}C$, $V_{OUT} = V_S$, unless otherwise noted; for TLV3011, $R_{PULL-UP} = 10k\Omega$ connected to V_S .

PARAMETER	CONDITION	TLV3011, TLV3012			UNITS
		MIN	TYP	MAX	
OFFSET VOLTAGE Input Offset Voltage vs Temperature vs Power Supply	V_{OS} dV_{OS}/dT PSRR $V_{CM} = 0V, I_O = 0V$ $T_A = -40^{\circ}C$ to $+125^{\circ}C$ $V_S = 1.8V$ to $5.5V$		0.5 ± 12 100	12 1000	mV $\mu V/^{\circ}C$ $\mu V/V$
INPUT BIAS CURRENT Input Bias Current Input Offset Current	I_B I_{OS} $V_{CM} = V_S/2$ $V_{CM} = V_S/2$		± 1 ± 1	± 10 ± 10	pA pA
INPUT VOLTAGE RANGE Common-Mode Voltage Range Common-Mode Rejection Ratio	V_{CM} CMRR $V_{CM} = -0.2V$ to $(V+) - 1.5V$ $V_{CM} = -0.2V$ to $(V+) + 0.2V$	$(V-) - 0.2V$ 60 54	74 62	$(V+) + 0.2V$	V dB dB
INPUT IMPEDANCE Common-Mode Differential			$10^{13} \parallel 2$ $10^{13} \parallel 4$		$\Omega \parallel pF$ $\Omega \parallel pF$
SWITCHING CHARACTERISTICS Propagation Delay Time, Low-to-High Propagation Delay Time, High-to-Low Rise Time, TLV3011 Rise Time, TLV3012 Fall Time	t_{PLH} t_{PHL} t_R t_F $f = 10kHz, V_{STEP} = 1V$ Input Overdrive = 10mV Input Overdrive = 100mV Input Overdrive = 10mV Input Overdrive = 100mV $C_L = 10pF$ $C_L = 10pF$		12 6 13.5 6.5 See Note 1 100 100		μs μs μs μs ns ns
OUTPUT Voltage Output Low from Rail Voltage Output High From Rail, TLV3012 Short-Circuit Current, TLV3012	V_{OL} $I_{OUT} = -5mA$ $I_{OUT} = 5mA$ $V_S = 5V$		160 90 See Typical Characteristics	200 200	mV mV
VOLTAGE REFERENCE Initial Accuracy Temperature Drift Load Regulation Sourcing Sinking Output Current Line Regulation	V_{OUT} dV_{OUT}/dT dV_{OUT}/dI_{LOAD} I_{LOAD} dV_{OUT}/dV_{IN} $V_{IN} = 5V$ $-40^{\circ}C \leq T_A \leq 125^{\circ}C$ $0mA < I_{SOURCE} \leq 0.5mA$ $0mA < I_{SINK} \leq 0.5mA$ $1.8V \leq V_{IN} \leq 5.5V$	1.230	1.242 40 0.36 6.6 0.5 10	1.254 ± 1 100 1 1 100	V % ppm/ $^{\circ}C$ mV/mA mV/mA mA $\mu V/V$
NOISE Reference Voltage Noise	$f = 0.1Hz$ to $10Hz$		0.2		mV _{PP}
POWER SUPPLY Specified Voltage Operating Voltage Range Quiescent Current	V_S I_Q $V_S = 5V, V_O = High$	1.8 1.8		5.5 5.5 5	V V μA
TEMPERATURE RANGE Specified Range Operating Range Storage Range Thermal Resistance, θ_{JA} SOT23-6 SC70-6		-40 -55 -55		+125 +150 +150	$^{\circ}C$ $^{\circ}C$ $^{\circ}C$ $^{\circ}C/W$ $^{\circ}C/W$

NOTE: (1) t_R dependent on $R_{PULL-UP}$ and C_{LOAD} .

TYPICAL CHARACTERISTICS

At $T_A = +25^\circ\text{C}$, $V_S = +1.8\text{V}$ to $+5.5\text{V}$, $R_{\text{PULL-UP}} = 10\text{k}\Omega$, and Input Overdrive = 100mV , unless otherwise noted.

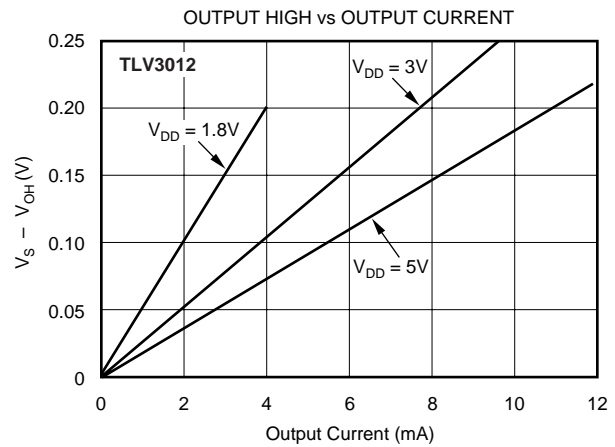
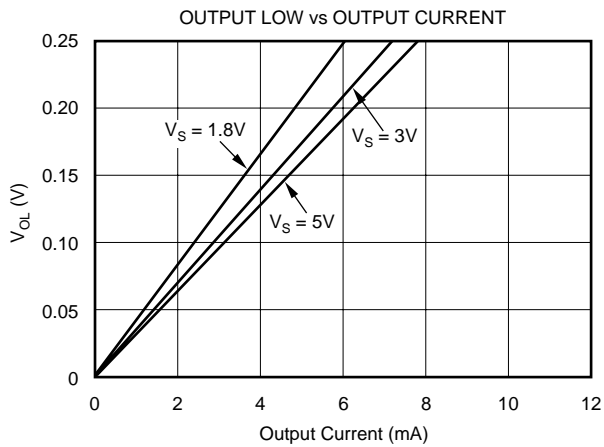
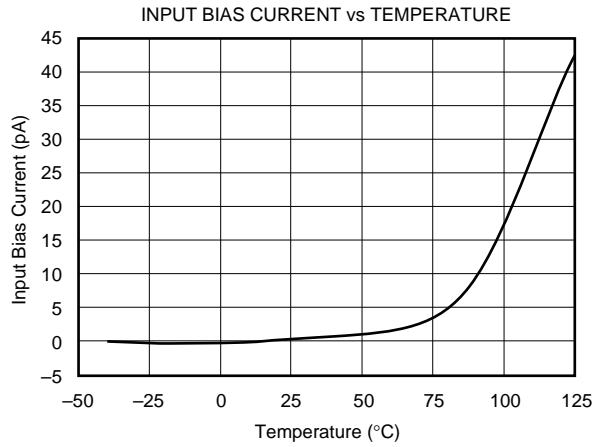
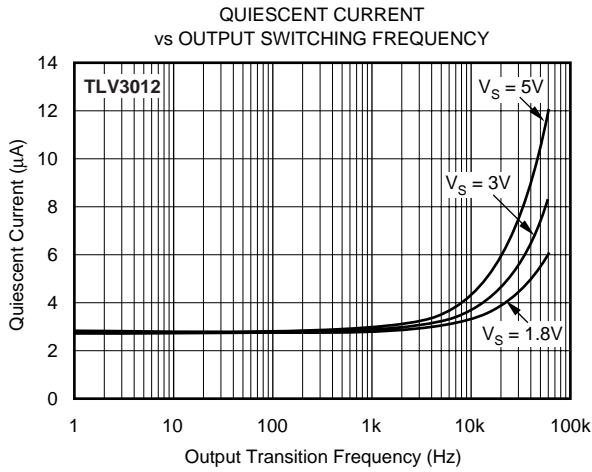
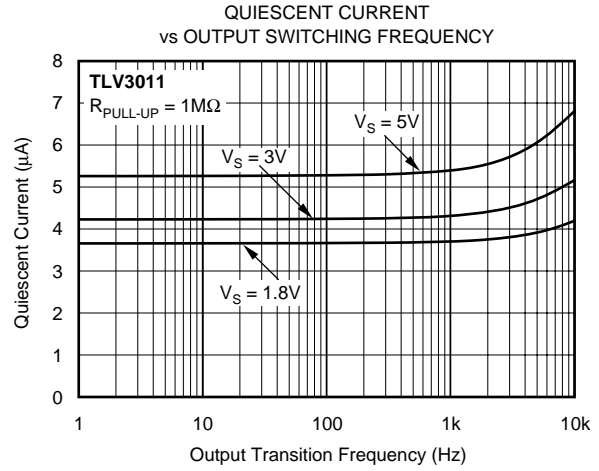
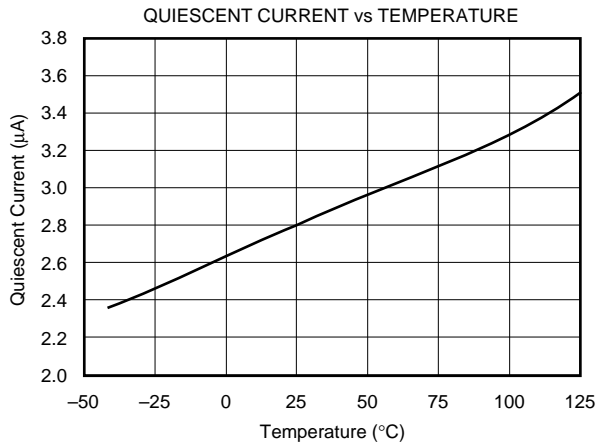

TYPICAL CHARACTERISTICS (Cont.)

At $T_A = +25^\circ\text{C}$, $V_S = +1.8\text{V}$ to $+5.5\text{V}$, $R_{PULL-UP} = 10\text{k}\Omega$, and Input Overdrive = 100mV , unless otherwise noted.

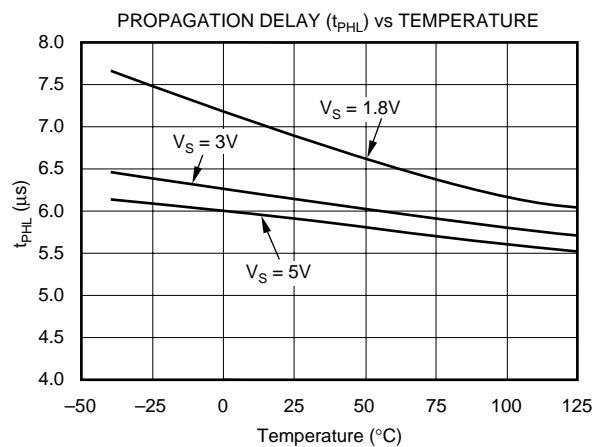
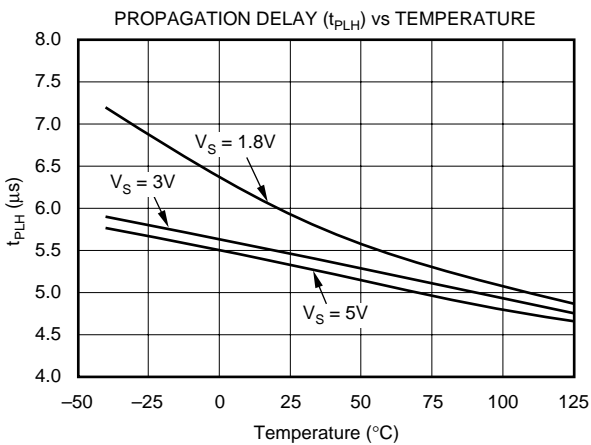
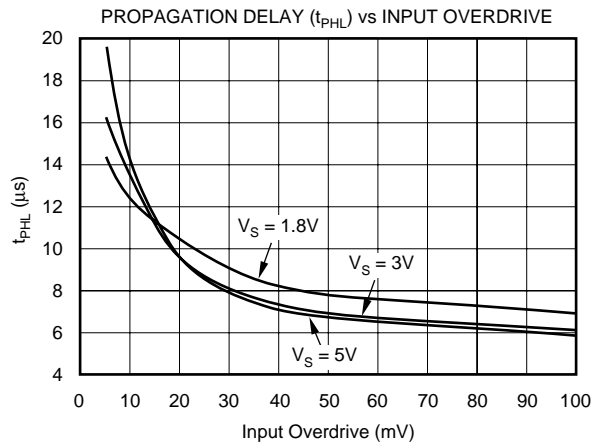
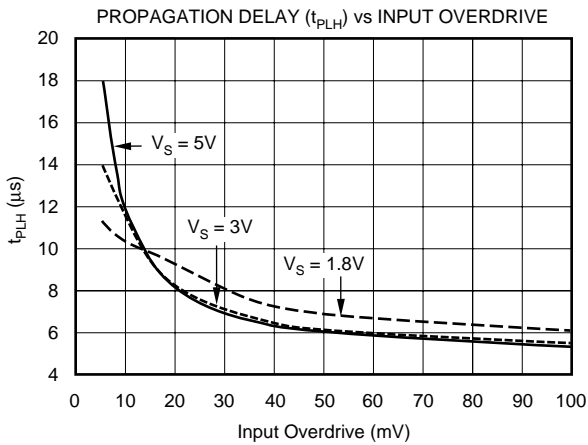
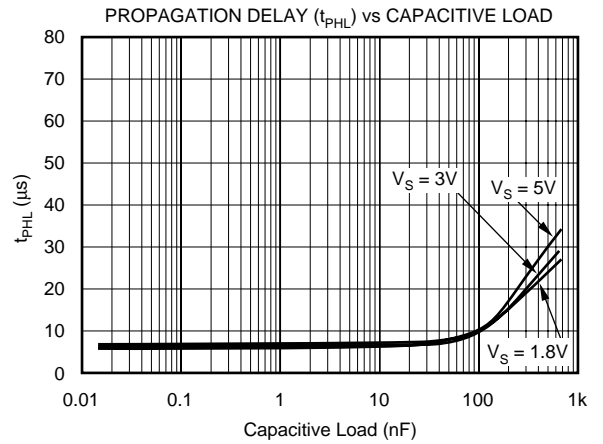
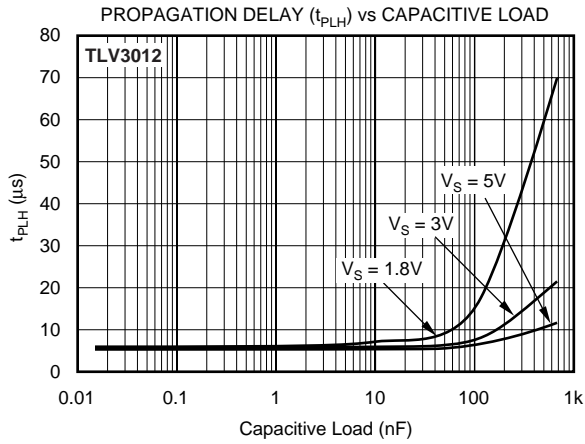

TYPICAL CHARACTERISTICS (Cont.)

At $T_A = +25^\circ\text{C}$, $V_S = +1.8\text{V}$ to $+5.5\text{V}$, $R_{PULL-UP} = 10\text{k}\Omega$, and Input Overdrive = 100mV , unless otherwise noted.

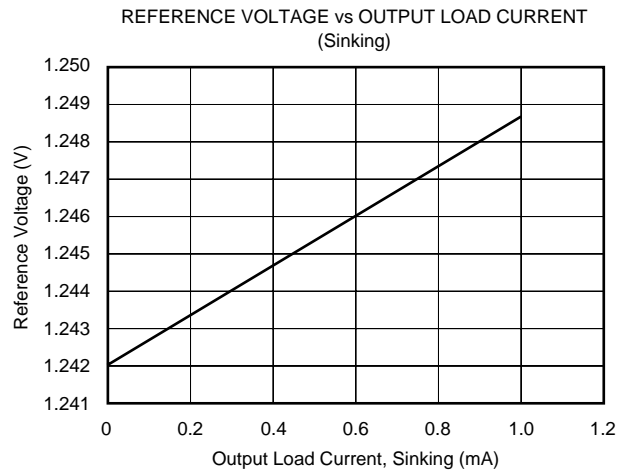
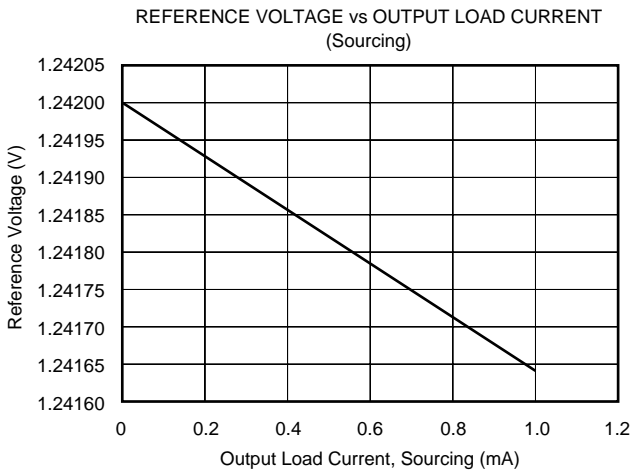
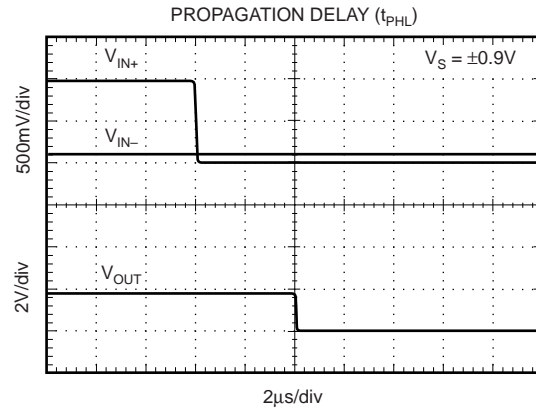
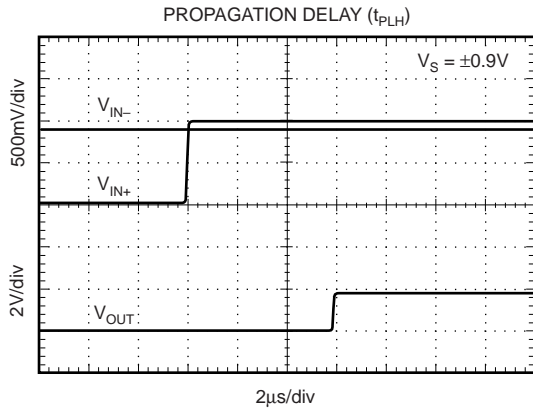
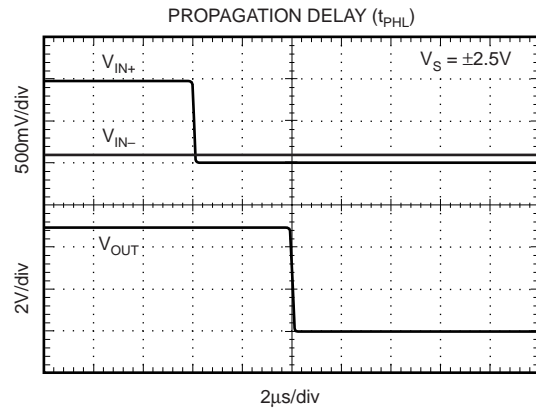
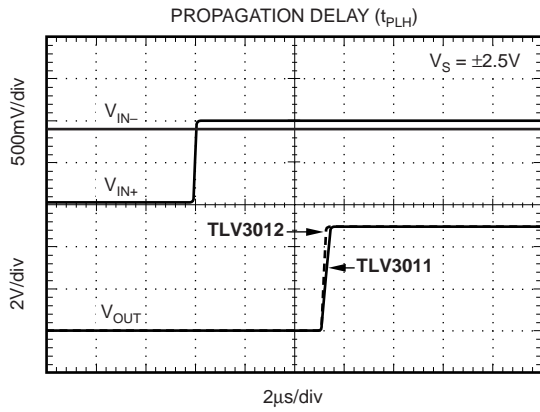

TYPICAL CHARACTERISTICS (Cont.)

At $T_A = +25^\circ\text{C}$, $V_S = +1.8\text{V}$ to $+5.5\text{V}$, $R_{\text{PULL-UP}} = 10\text{k}\Omega$, and Input Overdrive = 100mV , unless otherwise noted.

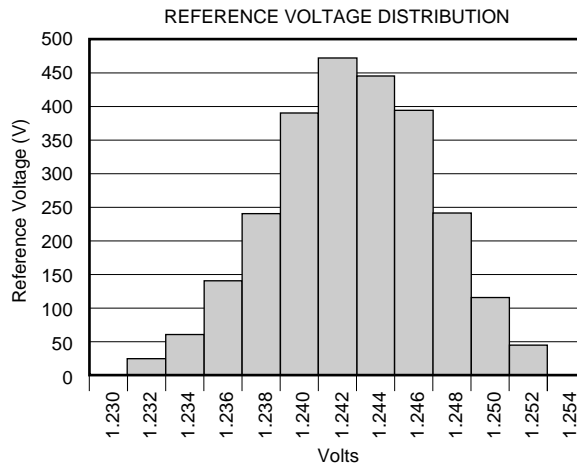
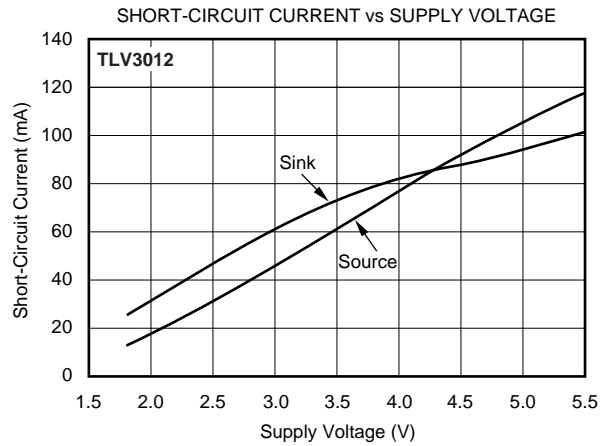
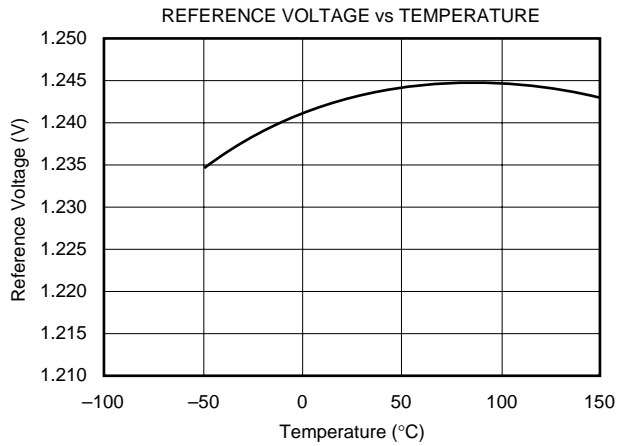

APPLICATIONS INFORMATION

The TLV3011 is a low-power, open-drain comparator with on-chip 1.242V series reference. The open-drain output allows multiple devices to be driven by a single pull-up resistor to accomplish an OR function, making the TLV3011 useful for logic applications.

The TLV3012 comparator with on-chip 1.242V series reference has a push-pull output stage optimal for reduced power budget applications and features no shoot-through current.

A typical supply current of 2.8µA and tiny packaging combine with 1.8V supply requirements to make the TLV3011 and TLV3012 optimal for battery and portable designs.

BOARD LAYOUT

Typical connections for the TLV3011 and TLV3012 are shown in Figure 1. The TLV3011 is an open-drain output device. A pull-up resistor must be connected between the comparator output and supply to enable operation.

To minimize supply noise, power supplies should be capacitively decoupled by a 0.01µF ceramic capacitor in parallel with a 10µF electrolytic capacitor. Comparators are sensitive to input noise, and precautions such as proper grounding (use of ground plane), supply bypassing, and guarding of high-impedance nodes will minimize the effects of noise and help to ensure specified performance.

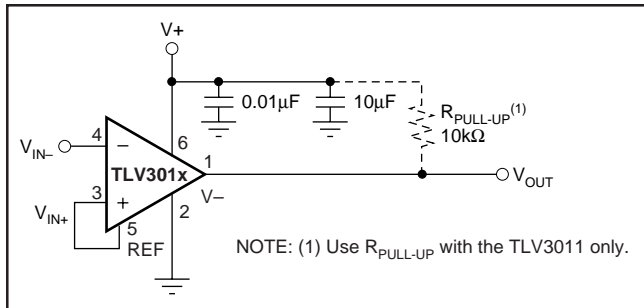

FIGURE 1. Basic Connections of the TLV3011 and TLV3012.

OPEN-DRAIN OUTPUT (TLV3011)

The open-drain output of the TLV3011 is useful in logic applications. The value of the pull-up resistor and supply voltage used will affect current consumption due to additional current drawn when the output is in a low state. This effect can be seen in the typical curve *Quiescent Current vs Output Switching Frequency*.

EXTERNAL HYSTERESIS

Comparator inputs have no noise immunity within the range of specified offset voltage (±12mV). For noisy input signals, the comparator output may display multiple switching as input signals move through the switching threshold. The typical comparator threshold of the TLV3011 and TLV3012 is ±0.5mV. To prevent multiple switching within the comparator threshold of the TLV3011 or TLV3012, external hysteresis

may be added by connecting a small amount of feedback to the positive input. Figure 2 shows a typical topology used to introduce hysteresis, described by the equation:

$$V_{HYST} = \frac{V^+ \times R_1}{R_1 + R_2}$$

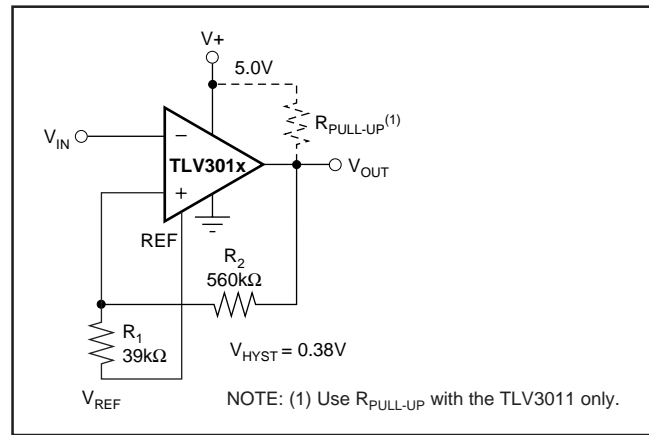

FIGURE 2. Adding Hysteresis.

V_{HYST} will set the value of the transition voltage required to switch the comparator output by increasing the threshold region, thereby reducing sensitivity to noise.

APPLICATIONS

BATTERY LEVEL DETECT

The low power consumption and 1.8V supply voltage of the TLV3011 make it an excellent candidate for battery-powered applications. Figure 3 shows the TLV3011 configured as a low battery level detector for a 3V battery.

$$\text{Battery-Okay Trip Voltage} = 1.242 \frac{R_1 + R_2}{R_2}$$

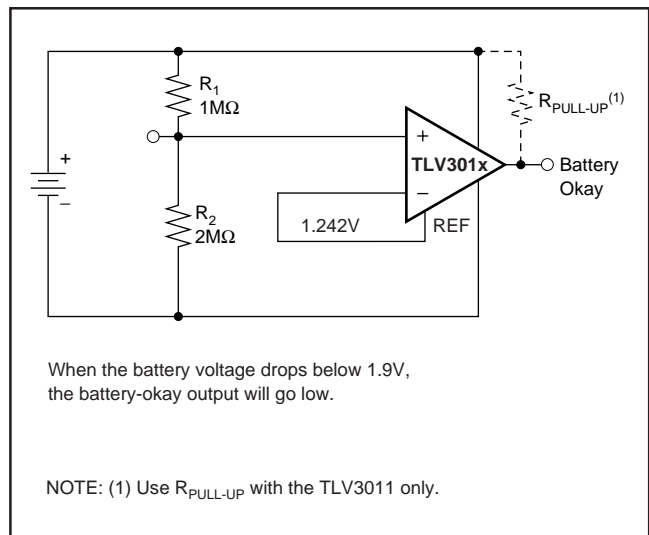

FIGURE 3. TLV3011 Configured as a Low Battery Level Detector.

POWER-ON RESET

The reset circuit shown in Figure 4 provides a time delayed release of reset to the MSP430 microcontroller. Operation of the circuit is based on a stabilization time constant of the supply voltage, rather than on a predetermined voltage value. The negative input is a reference voltage created by the internal voltage reference. The positive input is an RC circuit that provides a power-up delay. When power is applied, the output of the comparator is low, holding the processor in the reset condition. Only after allowing time for the supply voltage to stabilize does the positive input of the comparator become higher than the negative input, resulting in a high output state, releasing the processor for operation. The stabilization time required for the supply voltage is adjustable by the selection of the RC component values. Use of a lower-valued resistor in this portion of the circuit will not increase current consumption because no current flows through the RC circuit after the supply has stabilized.

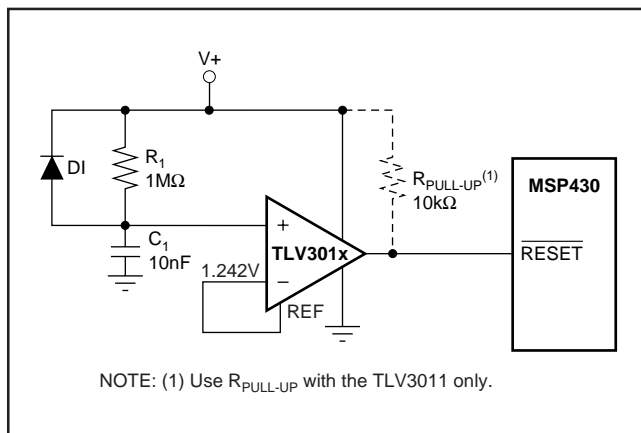

FIGURE 4. The TLV3011 or TLV3012 Configured as a Power Up Reset Circuit for the MSP430.

The reset delay needed depends on the power-up characteristics of the system power supply. R_1 and C_1 are selected to allow enough time for the power supply to stabilize. D_1 provides rapid reset if power is lost. In this example, the $R_1 \cdot C_1$ time constant is 10mS.

RELAXATION OSCILLATOR

The TLV3012 can be configured as a relaxation oscillator as in Figure 5 to provide a simple and inexpensive clock output. The capacitor is charged at a rate of $T = 0.69RC$. It also discharges at a rate of $0.69RC$. Therefore, the period is $T = 1.38RC$. R_1 may be a different value than R_2 .

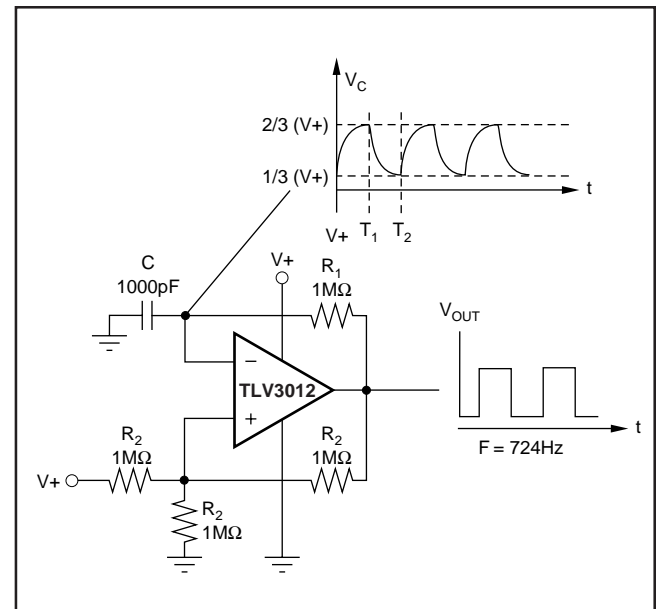

FIGURE 5. TLV3012 Configured as a Relaxation Oscillator.

PACKAGING INFORMATION

Orderable Device	Status ⁽¹⁾	Package Type	Package Drawing	Pins	Package Qty	Eco Plan ⁽²⁾	Lead/Ball Finish	MSL Peak Temp ⁽³⁾
TLV3011AIDBVR	ACTIVE	SOT-23	DBV	6	3000	Green (RoHS & no Sb/Br)	CU NIPDAU	Level-2-260C-1 YEAR
TLV3011AIDBVRG4	ACTIVE	SOT-23	DBV	6	3000	Green (RoHS & no Sb/Br)	CU NIPDAU	Level-2-260C-1 YEAR
TLV3011AIDBVT	ACTIVE	SOT-23	DBV	6	250	Green (RoHS & no Sb/Br)	CU NIPDAU	Level-2-260C-1 YEAR
TLV3011AIDBVTG4	ACTIVE	SOT-23	DBV	6	250	Green (RoHS & no Sb/Br)	CU NIPDAU	Level-2-260C-1 YEAR
TLV3011AIDCKR	ACTIVE	SC70	DCK	6	3000	Green (RoHS & no Sb/Br)	CU NIPDAU	Level-1-260C-UNLIM
TLV3011AIDCKRG4	ACTIVE	SC70	DCK	6	3000	Green (RoHS & no Sb/Br)	CU NIPDAU	Level-1-260C-UNLIM
TLV3011AIDCKT	ACTIVE	SC70	DCK	6	250	Green (RoHS & no Sb/Br)	CU NIPDAU	Level-1-260C-UNLIM
TLV3011AIDCKTG4	ACTIVE	SC70	DCK	6	250	Green (RoHS & no Sb/Br)	CU NIPDAU	Level-1-260C-UNLIM
TLV3012AIDBVR	ACTIVE	SOT-23	DBV	6	3000	Green (RoHS & no Sb/Br)	CU NIPDAU	Level-2-260C-1 YEAR
TLV3012AIDBVRG4	ACTIVE	SOT-23	DBV	6	3000	Green (RoHS & no Sb/Br)	CU NIPDAU	Level-2-260C-1 YEAR
TLV3012AIDBVT	ACTIVE	SOT-23	DBV	6	250	Green (RoHS & no Sb/Br)	CU NIPDAU	Level-2-260C-1 YEAR
TLV3012AIDBVTG4	ACTIVE	SOT-23	DBV	6	250	Green (RoHS & no Sb/Br)	CU NIPDAU	Level-2-260C-1 YEAR
TLV3012AIDCKR	ACTIVE	SC70	DCK	6	3000	Green (RoHS & no Sb/Br)	CU NIPDAU	Level-1-260C-UNLIM
TLV3012AIDCKRG4	ACTIVE	SC70	DCK	6	3000	Green (RoHS & no Sb/Br)	CU NIPDAU	Level-1-260C-UNLIM
TLV3012AIDCKT	ACTIVE	SC70	DCK	6	250	Green (RoHS & no Sb/Br)	CU NIPDAU	Level-1-260C-UNLIM
TLV3012AIDCKTG4	ACTIVE	SC70	DCK	6	250	Green (RoHS & no Sb/Br)	CU NIPDAU	Level-1-260C-UNLIM

⁽¹⁾ The marketing status values are defined as follows:

ACTIVE: Product device recommended for new designs.

LIFEBUY: TI has announced that the device will be discontinued, and a lifetime-buy period is in effect.

NRND: Not recommended for new designs. Device is in production to support existing customers, but TI does not recommend using this part in a new design.

PREVIEW: Device has been announced but is not in production. Samples may or may not be available.

OBSOLETE: TI has discontinued the production of the device.

⁽²⁾ Eco Plan - The planned eco-friendly classification: Pb-Free (RoHS), Pb-Free (RoHS Exempt), or Green (RoHS & no Sb/Br) - please check <http://www.ti.com/productcontent> for the latest availability information and additional product content details.

TBD: The Pb-Free/Green conversion plan has not been defined.

Pb-Free (RoHS): TI's terms "Lead-Free" or "Pb-Free" mean semiconductor products that are compatible with the current RoHS requirements for all 6 substances, including the requirement that lead not exceed 0.1% by weight in homogeneous materials. Where designed to be soldered at high temperatures, TI Pb-Free products are suitable for use in specified lead-free processes.

Pb-Free (RoHS Exempt): This component has a RoHS exemption for either 1) lead-based flip-chip solder bumps used between the die and package, or 2) lead-based die adhesive used between the die and leadframe. The component is otherwise considered Pb-Free (RoHS compatible) as defined above.

Green (RoHS & no Sb/Br): TI defines "Green" to mean Pb-Free (RoHS compatible), and free of Bromine (Br) and Antimony (Sb) based flame retardants (Br or Sb do not exceed 0.1% by weight in homogeneous material)

⁽³⁾ MSL, Peak Temp. -- The Moisture Sensitivity Level rating according to the JEDEC industry standard classifications, and peak solder temperature.

Important Information and Disclaimer:The information provided on this page represents TI's knowledge and belief as of the date that it is provided. TI bases its knowledge and belief on information provided by third parties, and makes no representation or warranty as to the accuracy of such information. Efforts are underway to better integrate information from third parties. TI has taken and continues to take reasonable steps to provide representative and accurate information but may not have conducted destructive testing or chemical analysis on incoming materials and chemicals. TI and TI suppliers consider certain information to be proprietary, and thus CAS numbers and other limited information may not be available for release.

In no event shall TI's liability arising out of such information exceed the total purchase price of the TI part(s) at issue in this document sold by TI to Customer on an annual basis.

TAPE AND REEL BOX INFORMATION

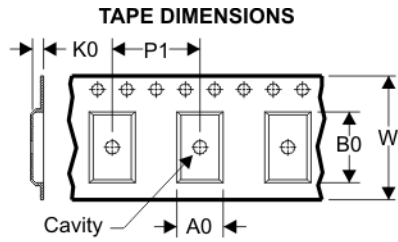
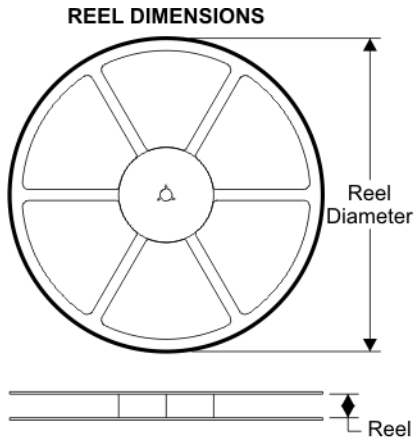

A0	Dimension designed to accommodate the component width
B0	Dimension designed to accommodate the component length
K0	Dimension designed to accommodate the component thickness
W	Overall width of the carrier tape
P1	Pitch between successive cavity centers

QUADRANT ASSIGNMENTS FOR PIN 1 ORIENTATION IN TAPE

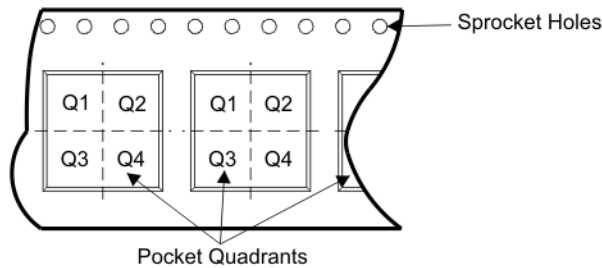

Device	Package	Pins	Site	Reel Diameter (mm)	Reel Width (mm)	A0 (mm)	B0 (mm)	K0 (mm)	P1 (mm)	W (mm)	Pin1 Quadrant
TLV3011AIDBVR	DBV	6	SITE 21	180	8	3.23	3.17	1.37	4	8	Q3
TLV3011AIDBVT	DBV	6	SITE 21	180	8	3.23	3.17	1.37	4	8	Q3
TLV3012AIDBVR	DBV	6	SITE 21	180	8	3.23	3.17	1.37	4	8	Q3
TLV3012AIDBVT	DBV	6	SITE 21	180	8	3.23	3.17	1.37	4	8	Q3

TAPE AND REEL BOX DIMENSIONS



Device	Package	Pins	Site	Length (mm)	Width (mm)	Height (mm)
TLV3011AIDBVR	DBV	6	SITE 21	214.0	199.0	55.0
TLV3011AIDBVT	DBV	6	SITE 21	214.0	199.0	55.0
TLV3012AIDBVR	DBV	6	SITE 21	214.0	199.0	55.0
TLV3012AIDBVT	DBV	6	SITE 21	214.0	199.0	55.0

DBV (R-PDSO-G6)

PLASTIC SMALL-OUTLINE PACKAGE



- NOTES:
- A. All linear dimensions are in millimeters.
 - B. This drawing is subject to change without notice.
 - C. Body dimensions do not include mold flash or protrusion. Mold flash and protrusion shall not exceed 0.15 per side.
 - D. Leads 1,2,3 may be wider than leads 4,5,6 for package orientation.
- \triangle Falls within JEDEC MO-178 Variation AB, except minimum lead width.

DCK (R-PDSO-G6)

PLASTIC SMALL-OUTLINE PACKAGE



- NOTES:
- A. All linear dimensions are in millimeters.
 - B. This drawing is subject to change without notice.
 - C. Body dimensions do not include mold flash or protrusion. Mold flash and protrusion shall not exceed 0.15 per side.
 - D. Falls within JEDEC MO-203 variation AB.

IMPORTANT NOTICE

Texas Instruments Incorporated and its subsidiaries (TI) reserve the right to make corrections, modifications, enhancements, improvements, and other changes to its products and services at any time and to discontinue any product or service without notice. Customers should obtain the latest relevant information before placing orders and should verify that such information is current and complete. All products are sold subject to TI's terms and conditions of sale supplied at the time of order acknowledgment.

TI warrants performance of its hardware products to the specifications applicable at the time of sale in accordance with TI's standard warranty. Testing and other quality control techniques are used to the extent TI deems necessary to support this warranty. Except where mandated by government requirements, testing of all parameters of each product is not necessarily performed.

TI assumes no liability for applications assistance or customer product design. Customers are responsible for their products and applications using TI components. To minimize the risks associated with customer products and applications, customers should provide adequate design and operating safeguards.

TI does not warrant or represent that any license, either express or implied, is granted under any TI patent right, copyright, mask work right, or other TI intellectual property right relating to any combination, machine, or process in which TI products or services are used. Information published by TI regarding third-party products or services does not constitute a license from TI to use such products or services or a warranty or endorsement thereof. Use of such information may require a license from a third party under the patents or other intellectual property of the third party, or a license from TI under the patents or other intellectual property of TI.

Reproduction of TI information in TI data books or data sheets is permissible only if reproduction is without alteration and is accompanied by all associated warranties, conditions, limitations, and notices. Reproduction of this information with alteration is an unfair and deceptive business practice. TI is not responsible or liable for such altered documentation. Information of third parties may be subject to additional restrictions.

Resale of TI products or services with statements different from or beyond the parameters stated by TI for that product or service voids all express and any implied warranties for the associated TI product or service and is an unfair and deceptive business practice. TI is not responsible or liable for any such statements.

TI products are not authorized for use in safety-critical applications (such as life support) where a failure of the TI product would reasonably be expected to cause severe personal injury or death, unless officers of the parties have executed an agreement specifically governing such use. Buyers represent that they have all necessary expertise in the safety and regulatory ramifications of their applications, and acknowledge and agree that they are solely responsible for all legal, regulatory and safety-related requirements concerning their products and any use of TI products in such safety-critical applications, notwithstanding any applications-related information or support that may be provided by TI. Further, Buyers must fully indemnify TI and its representatives against any damages arising out of the use of TI products in such safety-critical applications.

TI products are neither designed nor intended for use in military/aerospace applications or environments unless the TI products are specifically designated by TI as military-grade or "enhanced plastic." Only products designated by TI as military-grade meet military specifications. Buyers acknowledge and agree that any such use of TI products which TI has not designated as military-grade is solely at the Buyer's risk, and that they are solely responsible for compliance with all legal and regulatory requirements in connection with such use.

TI products are neither designed nor intended for use in automotive applications or environments unless the specific TI products are designated by TI as compliant with ISO/TS 16949 requirements. Buyers acknowledge and agree that, if they use any non-designated products in automotive applications, TI will not be responsible for any failure to meet such requirements.

Following are URLs where you can obtain information on other Texas Instruments products and application solutions:

Products		Applications	
Amplifiers	amplifier.ti.com	Audio	www.ti.com/audio
Data Converters	dataconverter.ti.com	Automotive	www.ti.com/automotive
DSP	dsp.ti.com	Broadband	www.ti.com/broadband
Interface	interface.ti.com	Digital Control	www.ti.com/digitalcontrol
Logic	logic.ti.com	Military	www.ti.com/military
Power Mgmt	power.ti.com	Optical Networking	www.ti.com/opticalnetwork
Microcontrollers	microcontroller.ti.com	Security	www.ti.com/security
RFID	www.ti-rfid.com	Telephony	www.ti.com/telephony
Low Power Wireless	www.ti.com/lpw	Video & Imaging	www.ti.com/video
		Wireless	www.ti.com/wireless

Mailing Address: Texas Instruments, Post Office Box 655303, Dallas, Texas 75265
Copyright © 2007, Texas Instruments Incorporated