



elektor

electronics worldwide



Grab that data ...

USB Data Acquisition Card

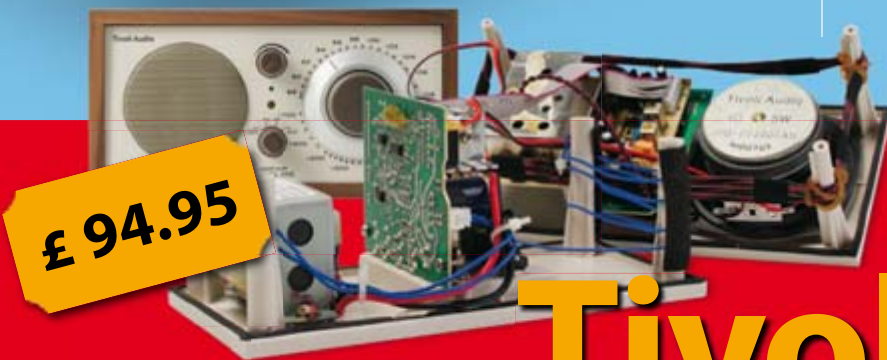

£ 94.95

Tivoli

love it or leave it?

- 8051 Board on USB
 - Headphone Amp with 3D Sound
 - The Challenge
- Win** a notebook PC or a router!



9 770268 45112 8 R47 11

Get Ready for Christmas with these GREAT Audio Kits

Top Selling AUDIO/VIDEO Kits

IR Remote Control Extender MKII

KC-5432 £7.25 + post & packing

Operate your DVD player or digital decoder using its remote control from another room. It picks up the signal from the remote control and sends it via a 2-wire cable to an infrared LED located close to the device. This improved model features fast data transfer, capable of transmitting Foxtel digital remote control signals using the Pace 400 series decoder. Kit supplied with case, screen printed front panel, PCB with overlay and all electronic components.



Requires 9VDC wall adaptor (Maplin #GS74R £10.99)

4 Channel Guitar Amplifier Kit

KC-5448 £28.75 + post & packing

This is an improved version of our popular guitar mixer kit and has a number of enhancements that make it even more versatile. The input sensitivity of each of the four channels is adjustable from a few millivolts to over 1 volt, so you plug in a range of input signals from a microphone to a line level signal from a CD player etc. A headphone amplifier circuit is also included for monitoring purposes. A three stage EQ is also included, making this a very versatile mixer that will operate from 12 volts. Kit includes PCB with overlay & all electronic components.



Universal Stereo Preampifier Kit

KC-5159 £5.25 + post and packing

Based around the low noise LM833 dual op-amp IC, this preamp is designed for use with a magnetic cartridge, cassette deck or dynamic microphone. It features RIAA/IEC equalisation, and is supplied with all components to build either the phono, tape or microphone version.

- Measuring only 80 x 78 x 30mm, it is ideal for incorporating into existing equipment and is hence supplied short form of PCB and specified components plus PCB standoffs for mounting.

- +/- 15VDC required



Theremin Synthesiser Kit

KC-5295 £14.75 + post and packing

The Theremin is a weird musical instrument that was invented early last century but is still used today. The Beach Boys' classic hit "Good Vibrations" featured a Theremin. By moving your hand between the antenna and the metal plate, you create strange sound effects like in those scary movies! Kit includes a machined, silkscreened and pre drilled case, circuit board, all electronic components, and clear English instructions.

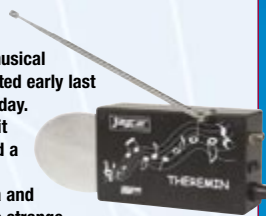

Requires 12VDC wall adaptor (Maplin #GSR74R £9.99)

Smart Card Reader and Programmer Kit

KC-5361 £15.95 + post & packing

Program both the microcontroller and EEPROM in the popular gold, silver and emerald wafer cards. Card used needs to conform to ISO-7816 standards, which includes ones sold by Jaycar. Powered by 9-12 VDC wall adaptor or a 9V battery. Instructions outline software requirements that are freely available on the internet. Kit supplied with PCB, wafer card socket and all electronic components. PCB measures: 141 x 101mm.

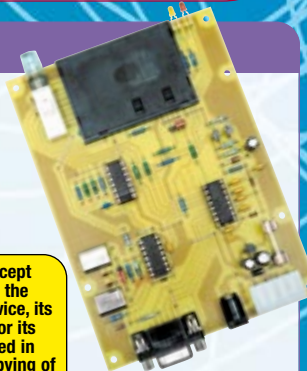

Requires 9-12VDC wall adaptor (Maplin #UG01B £13.99)

Jaycar cannot accept responsibility for the operation of this device, its related software, or its potential to be used in relation to illegal copying of smart cards in cable TV set top boxes.

Build-Yourself Electronic Project Kits

Looking for a particular KIT?

Checkout Jaycar's extensive range.

We have kits and electronic projects for use in:

- Audio & Video
- Car & Automotive
- Computer
- Learning & Educational
- Lighting
- Power
- Test & Meters
- General Electronics Projects - just for fun!



430+ pages
ALL prices in PDS

Post and Packing Charges

Order Value	Cost	Order Value	Cost
£10 - £49.99	£5	£200 - £499.99	£30
£50 - £99.99	£10	£500+	£40
£100 - £199.99	£20		

Max weight 12lb (5kg). Heavier parcels POA.
Minimum order £10.

Note: Products are despatched from Australia, so local customs duty and taxes may apply.

How to order:

Phone: Call Australian Eastern Standard Time Mon-Fri on 0800 032 7241

Email: techstore@jaycarelectronics.co.uk

Post: PO BOX 6424, Silverwater NSW 1811. Australia
Expect 10-14 days for air parcel delivery

Check out the Jaycar range in your FREE Catalogue - logon to

www.jaycarelectronics.co.uk/elektor

or check out the range at

www.jaycarelectronics.co.uk

0800 032 7241

(Monday - Friday 09.00 to 17.30 GMT + 10 hours only)

For those who want to write: 100 Silverwater Rd
Silverwater NSW 2128 Sydney AUSTRALIA



- ORDER ON-LINE
- ALL PRICING IN POUND STERLING
- MINIMUM ORDER ONLY £10

Accessories

PCB Holder with Magnifying Glass

TH-1983 £3.75 + post and packing

Anytime you need that extra bit of help with your PCB assembly, this pair of helping hands will get you out of trouble. With a 90mm magnifying glass, it also provides an extra pair of eyes.

- Size: Base: 78 x 98mm
- Height: 145mm



Resistance Wheel

RR-0700 £5.75 + post and packing

Convenient resistance selection. Select from 36 values from 5 ohms to 1M ohms.

- Comes complete with leads and insulated crocodile clips.
- Uses 0.25W resistors with 5% tolerance



Component Lead Forming Tool

TH-1810 £2.00 + post and packing

Get the hole spacing for your resistors and diodes perfect every time. This handy forming tool provides uniform hole spacing from 10 to 38mm.

Suitable for production assembly, education and training. The tool is double sided with one side for use with D047 outline diodes (eg 1N914) and 1W zener diodes; the other side being suitable for 1/5W resistors, D041 outline diodes (eg 1N4004). An incredibly handy tool!



Logon to website for more service aids.

Magnifier Headset

QM-3510 £8.50 + post and packing

Minimising eyestrain while leaving your hands free this headset gives a wide field of vision, can be worn over prescription eyeglasses and can be tilted up out of the way when not in use. Four different magnifications, lightweight, excellent for close work.



Jaycar
Electronics

2007 Portable Power Design Seminar

Birmingham

December 5, 2007

To register, and for additional information, visit:

www.ti.com/portable-power-ekt-uk



HIGH-PERFORMANCE ANALOG



YOUR WAY™

Technology for Innovators™

 TEXAS INSTRUMENTS

The human factor

The other week, during a seminar on CAD and electronic simulation, organised jointly by Elektor and National Instruments Electronics Workbench Group, I had an opportunity to have a chat with a couple of Elektor readers. We were joined by two Multisim 10 experts and marketing staff from National Instruments. As the conversation went on, it dawned upon me that especially younger electronics enthusiasts are in real danger of becoming socially isolated because so many things can be done with just a PC and a pizza as companions in the ongoing quest called circuit design. Now although the PC is a great tool and a good (if not essential) investment, be it for making a living from electronics, or just curious to explore the field, it will only beep at you occasionally, or produce arcane error codes like runtime error -6001. Electronics is learned from books, magazines, components trays and living people. Give it a try, you will find them friendlier, more forgiving and inspiring than the average PC with Internet and a host of CAD stuff installed on it. Talking to an older engineer is like opening the pages of an encyclopaedia.

Another great place to learn about electronics in a very practical way seems to have disappeared completely: old Rupert's electronic parts retail shop, where you could enjoy the shoptalk while waiting to be served, scribbled parts lists in hand. I learned 'compospeak' in such shops, and after a while became conversant with terms like trannies (transistors), O/P and I/P (output and input), duds, caps, HT (high tension), DOA (dead on arrival), toasted, blown up and plans. Funny to see that many of these terms are still used; you see them occasionally in newsgroup messages where they reveal the age of the author. In the old shops, it was not uncommon for customers to help each other as well as the assistant behind his till with any bit of information or gossip they were willing to share. For example, designs that were 'no good', or an interesting type code for a 'super replacement part' — cheaper, too'.

Although much more conversation on electronics is going on these days in newsgroups and forums, the tone is sometimes flippant or aggressive, and from reading these messages I often get the impression that people lack the spirit of those that enabled electronics as an educational pastime to run cheerfully alongside all things professional, and continue to exist to this day.

Jan Buiting, Editor

USB Data Acquisition Card

16



This advanced board for connection to the USB has eight digital outputs, eight digital inputs, two 10-bit analogue outputs and eight 10-bit analogue inputs for voltage swings of 0 to 5 V. The system's core is a Microchip USB-savvy microcontroller type PIC18F4550. Good news: the micro is housed in a DIP40 case, and programmed in C.

22 USB Flash Board

This versatile Flash Board is built around an AT89C5131A, which is an extended 8051-family microcontroller with an 80C52 core and a Full Speed USB port.

As a sort of bonus, the IC has a complete update interface for downloading new firmware. Atmel also provides suitable software in the form of its FLIP program, which is available free of charge.

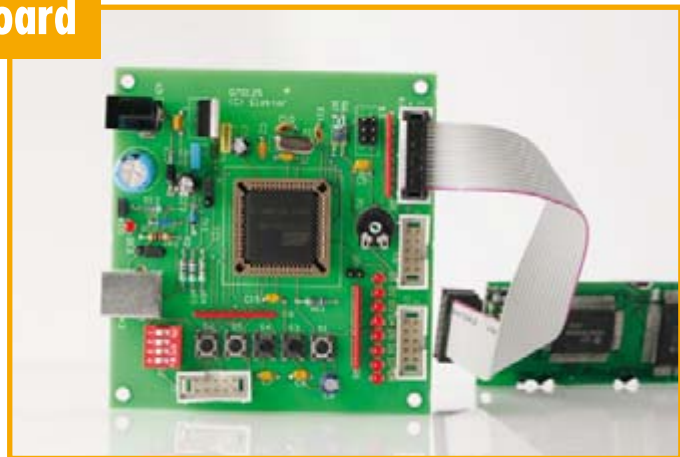

CONTENTS

Volume 33
November 2007
no. 371

40 The Challenge

On the bench is a notebook with an Intel processor and the specifications mentioned in this article. Manage to keep this 'unplugged' notebook running for half an hour and you have a chance of winning a notebook

PC or one of five Netgear Rangenmax wireless routers.

Be creative!

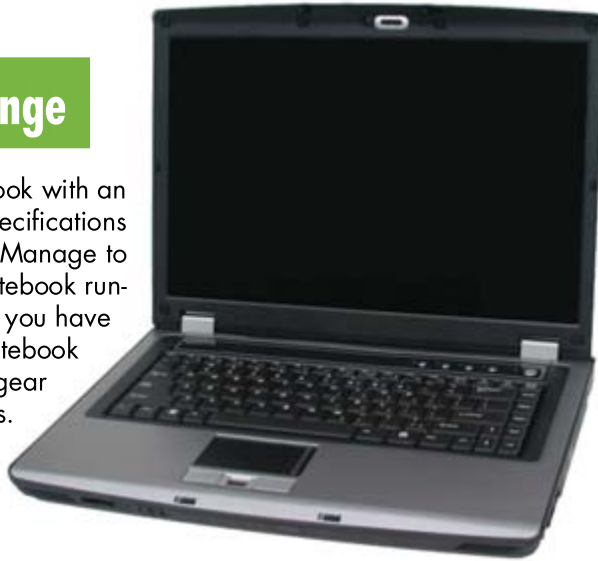

42 Stay Tuned to G8JCFSDR

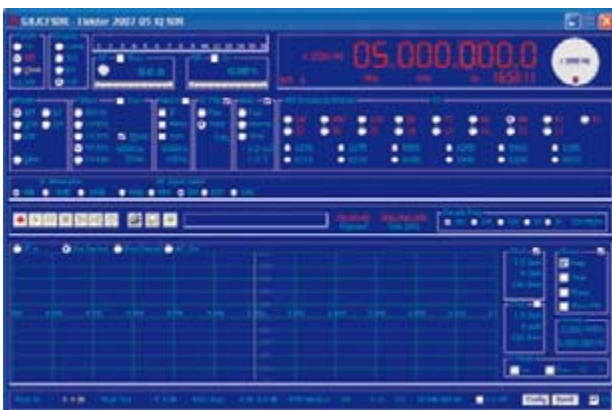

The G8JCFSDR software in conjunction with simple down-converter hardware like Elektor's May 2007 SDR (the best, and a real blockbuster) provides an extremely cost-effective, incredibly flexible and versatile receiver combination.

46 Low-cost Heating Controller

This article describes the construction of a flexible, programmable heating control unit which takes into account the outdoor temperature. It's pretty intelligent, using state of the art electronics around an ATmega32 microcontroller.



projects

- 16** USB Data Acquisition Card
- 22** USB Flash Board
- 28** Line Switcher
- 34** Headphone Amp with 3D Sound
- 42** Stay Tuned to G8JCFSDR
- 46** Low-cost Heating Controller
- 60** E-blocks Tachometer/Timer
- 68** Mesmerising Images

technology

- 38** Tivoli — i lov' it
- 40** The Challenge
- 64** Rapid Manufacturing for Electronics Enclosures

info & market

- 6** Colophon
- 8** Mailbox
- 10** News & New Products
- 52** Handiwork (soldering & etching)
- 56** Developing a Prototype
- 58** Hydra Game Development Kit
- 72** LogicSim (review)
- 80** Elektor SHOP
- 84** Sneak Preview

infotainment

- 76** Hexadoku
- 77** Retronics
Philips type ESC
'Semafoon' Pager (1962)

elektor international media

Elektor International Media provides a multimedia and interactive platform for everyone interested in electronics.

From professionals passionate about their work to enthusiasts with professional ambitions.

From beginner to diehard, from student to lecturer. Information, education, inspiration and entertainment.

Analogue and digital; practical and theoretical; software and hardware.

English
German
Dutch
French
Chinese

Greek
Spanish
Swedish
Finnish

Volume 33, Number 371, November 2007

ISSN 0268/4519

Elektor is also published in French, Spanish, German and Dutch. Together with franchised editions the magazine is on circulation in more than 50 countries.

Editorial secretariat: Hedwig Hennekens (secretariaat@elektor.nl)

Elektor Electronics aims at inspiring people to master electronics at any personal level by presenting construction projects and spotting developments in electronics and information technology.

Graphic design / DTP: Giel Dols, Mart Schroijen

Publishers: Elektor International Media, Regus Brentford, 1000 Great West Road, Brentford TW8 9HH, England. Tel. (+44) 208 261 4509, fax: (+44) 208 261 4447 www.elektor.com

Managing Director / Publisher: Paul Snakkers

Marketing: Carlo van Nistelrooy

Customer Services: Anouska van Ginkel

The magazine is available from newsagents, bookshops and electronics retail outlets, or on subscription.

Elektor is published 11 times a year with a double issue for July & August.

International Editor: Mat Heffels (m.heffels@elektor.nl), Wisse Hettinga (w.hettinga@elektor.nl)

Editor: Jan Buiting (editor@elektor.com)

International editorial staff: Harry Baggen, Thijs Beckers, Ernst Krempelsauer, Jens Nickel, Guy Raedersdorf.

Design staff: Antoine Authier, Ton Giesberts, Paul Goossens, Luc Lemmens, Jan Visser, Christian Vossen

Subscriptions: Elektor International Media, Regus Brentford, 1000 Great West Road, Brentford TW8 9HH, England. Tel. (+44) 208 261 4509, fax: (+44) 208 261 4447 Internet: www.elektor.com

A world of electronics from a single shop

Brand new shop pages in Elektor!

NEW!

Books

Highlights from the Elektor's book portfolio. Not just the latest titles but also top selling publications from the past. Elektor has books on a wide variety of subjects!

CD-ROMs

Our digital media collection. Software, hardware, education and, of course, lots of Elektor magazine articles! Nearly all disciplines from the wide fields of electronics and information technology are represented.

Kits & Modules

Whether you prefer to build up boards for yourself, or enjoy the ease of a ready-made module, Elektor supplies a kit of parts or a ready-populated and tested board with many projects published in the magazine. We leave the choice up to you!

Also monthly in the restyled Elektor Shop:

- **Bestsellers:** listing the five top selling publications for each medium
- **Product Shortlist:** printed circuit boards, software and microcontrollers arranged by month of publication
- **Ordering Info:** fast and easy ordering via Elektor's online shop or the Order Form in the magazine



elektor
SHOP

Go to page 80 to see all the enhancements!

Email: subscriptions@elektor.com
Rates and terms are given on the Subscription Order Form

Head Office: Elektor International Media b.v.
P.O. Box 11 NL-6114-ZG Susteren The Netherlands
Telephone: (+31) 46 4389444, Fax: (+31) 46 4370161

Distribution: Seymour, 2 East Poultry Street, London EC1A, England
Telephone: +44 207 429 4073

UK Advertising: Huson International Media, Cambridge House,
Gogmore Lane, Chertsey, Surrey KT16 9AP, England.
Telephone: +44 1932 564999, Fax: +44 1932 564998

Email: p.brady@husonmedia.com
Internet: www.husonmedia.com
Advertising rates and terms available on request.

International Advertising: Frank van de Raadt, address as Head Office
Email: advertenties@elektor.nl
Advertising rates and terms available on request.

Copyright Notice
The circuits described in this magazine are for domestic use only. All drawings, photographs, printed circuit board layouts, programmed integrated circuits, disks, CD-ROMs, software carriers and article texts published in our books and magazines (other than third-party advertisements) are copyright Segment. b.v. and may not be reproduced or transmitted in any form or by any means, including photocopying, scanning on recording, in whole or in part without

prior written permission from the Publishers. Such written permission must also be obtained before any part of this publication is stored in a retrieval system of any nature. Patent protection may exist in respect of circuits, devices, components etc. described in this magazine. The Publisher does not accept responsibility for failing to identify such patent(s) or other protection. The submission of designs or articles implies permission to the Publishers to alter the text and design, and to use the contents in other Segment publications and activities. The Publishers cannot guarantee to return any material submitted to them.

Disclaimer
Prices and descriptions of publication-related items subject to change.
Errors and omissions excluded.

© Elektor International Media B.V. 2007

Printed in the Netherlands



Elektor Electronics worldwide

Dear Sir — I have just received my subscription copy of *Elektor* October 2007 no. 370 and was very interested to read the 'Elektor electronics worldwide' article on page 16 detailing the growth of *Elektor* over the years. Working with so many languages in this highly technical area must require dedicated top notch people.

I have a complete English edition set. Yes all 370 issues of the English language edition of *Elektor* which sit proudly on my bookcase in *Elektor* binders providing perhaps a unique history of the development of electronics with associated projects. While this collection is probably not unique I did get each one at the time of issue and each has been read, and reread, and many projects, big and small, have been completed using the information contained therein, all with much associated pleasure. At the beginning very small projects. Even now, after all these years, I can still remember the enormous thrill and surprise at hearing, for the first time, the sound from a very small speaker of a transistor based astable multivibrator built using very few components. It worked and it was magic. But *Elektor* taught me that is wasn't. But you know what I mean. The photograph of issue no. 1 from December 1974, with its tangled mass of components on the front reminded me of a thought from the time – "That will never work!" But it in no way reflected the quality of what was inside the magazine both then and ever since. The caption by the picture notes that it's bound to appear on Flog It. I have no such plans. My difficult decision is which one of my two sons will eventually get my *Elektor* collection and which one will get the house hopefully in many years time and after many more *Elektors*! Keep up the great magazine and thanks.

Terry Ladbrook

Thank you for your kind words about our magazine. Here at Elektor central offices I am the keeper of all magazine issues published since no. 1. The collection was in danger of getting lost or destroyed several times as the company moved to different places. I also have one copy of every book, booklet and CD Elektor published over the past 34 years.

Amplifier modules test (1)

Dear Jan — I found your test of eleven audio amplifier modules in the September 2007 issue very interesting. On examining the measured results, I noticed that the bandwidth of the analyser used to make the THD measurements was not stated. In addition, the load at which the power bandwidth of the amplifiers was

measured (4 ohms or 8 ohms) was not stated.



Surely these are important factors, especially for measuring class-D amplifiers with LC output filters.

S. Tantikovit (by email)

You are right – this information is certainly useful for properly assessing the measured results. The bandwidth of the analyser used to make the THD measurements was 80 kHz, and all amplifiers were operated with a 4-ohm load for the bandwidth measurements.

Amplifier modules test (2)

Hello dear Editor — each month I look forward to reading your magazine, and no difference this time with the September 2007 issue. It started good, and right up to the article about audio amplifier modules it became interesting, but then: what the ~~beep~~, No word whatsoever on or about the innovative ICE Power block from B&O in Denmark. I'm astounded and still gasping for air :-).

In an article like that, how could you overlook/avoid the ICE Power blocks?

Klavs Rommedahl (Denmark)

We did not overlook the ICE power blocks for our article, but as far as we know these modules are only available to equipment manufacturers. In our overview we only tested modules which are available to private persons for home use.

Magnetometer LEDs

Dear Editor — the magnetometer design published in the May 2007 issue is indeed extremely sensitive, but with my unit LED #10 is the most sensitive, while LED #1 is the

last to light up. According to the text, this is not what I would have expected. Am I missing something here?

J.U. Lummerzheim (Germany)

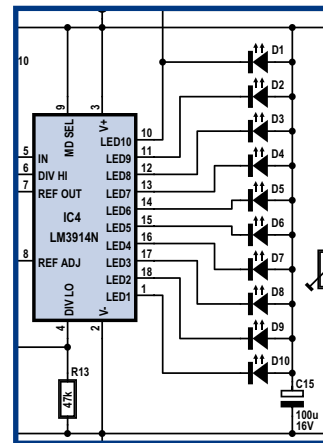

Your circuit is working properly. LED D10 (connected to the LED1 output of the LM3914) is simply a supply voltage indicator (as mentioned in the text), and it is always on. The actual LED indicator scale starts at the bottom with D9 (connected to the LED2 output of IC4) and ends with D1 (connected to the LED10 output of the LM3914). We must admit that it would have been more logical to assign the LEDs component numbers corresponding to the sequence of the IC outputs.

Different LC displays in the battery charger

Dear Jan —the Charge'n-Check battery charger in the April 2007 issue of *Elektor* uses a 'standard' LC display with two lines of 16 characters. Despite the large number of manufacturers and sources of such displays, there are usually not any problems with compatibility. But as the saying goes, the exception proves the rule.

I built the battery charger using a perfectly ordinary 2-line display (purchased from Bürklin), but only one line was active on my display. At first, I looked for the cause of the problem in the software (timing problems), but the program

worked perfectly. The problem could not be due to the display module, because two other compatible displays behaved exactly the same way in the battery charger, while all three displays worked flawlessly in other circuits. I also considered an error in the firmware, which was developed by a pro (Florent Coste) and tested in the *Elektor* lab, to be out of the question. I was thus left with no other choice than to assemble the display with the microcontroller in a separate circuit and check things out with a small test program. Although the hardware was very fast in this configuration, using the development environment for the ST7FMC2S4 (including the emulator) was quite a challenge. Using this test setup, I finally managed to get the display to work properly with the ST7FMC2S4 in 4-bit mode. At this point, I had narrowed the problem down to the point that everything pointed toward a bug in display initialisation. After carefully studying the program, I discovered the display initialisation routine and found that the first command it sends to the display in 4-bit mode is a 4-bit initialisation command. However, in a data sheet for a similar display I had read that the first command must be an 8-bit command. Now what can you do when you only have four lines available? The command for initialising the 4-bit mode is 28H. The 4-bit mode is selected by 20H, while 28H selects the 4-bit mode with two-line display mode.

I thus had the idea of first using a write instruction to issue the 20H command. With '2' in the upper four bits and the lower 4 bits tied to ground and thus equal to '0', this would be the same as an 8-bit 20H command. The 28H command could then be sent to the display by two subsequent write instructions, followed by the other commands (each in two parts as well). And voilá: after the modified program

```
LCD_Init(); // init LCD

Here is the initialisation routine in LCD.C:

void LCD_Init(void)
{
    LCD_Timer = 50; // 100 ms timeout
    SetBit(LCD_Flag,LCD_OK);
    while (chk_busy() == TRUE)
    {
        if (LCD_Timer == 0)
        {
            Beep_LCD_Fault();
        }
    }
}

/* Modified in the program */
LCD_send_inst_spez();
LCD_send_inst(LCD_ON);
LCD_send_inst(LCD_Clear);
}

/* Modified in the program */

void LCD_send_inst_spez(void)
{
    int i;

    /* First initialise the display in 8-bit mode: send
    1 command to the display */

    BitClr(RW);
    data_bus_load((u8)(0x20>>4)); // Select 4-bit
communication protocol
    BitClr(RS);
    BitSet(E);
    Nop();
    BitClr(E);
    BitSet(RS);
    for (i=0;i<=255;i++) Nop(); // Delay

    /* Second initialisation in 4-bit mode: send 2
nibbles to the display */

    BitClr(RW);
    data_bus_load((u8)(0x28>>4)); // 4-bit
communication protocol
    BitClr(RS);
    BitSet(E);
    Nop();
    BitClr(E);
    BitSet(RS);

    data_bus_load((u8)(0x28&0x0f)); // 1 line
    BitClr(RS);
    BitSet(E);
    Nop();
    BitClr(E);
    BitSet(RS);
    while (chk_busy() == TRUE) {};
}
}
```

was downloaded to then microcontroller of the battery charger, the display worked properly with two lines.

My suspicion that the author (Florent Coste) must have used a display that does not exhibit this problem was confirmed by a call to him. The display he used in his prototype was a Wintek WM-D1602Z-1GNNa, which has a pure 4-bit inter-

face. In my case, the display was a MDLS16265SS, which has a 4/8-bit interface. The widely used 4/8-bit display modules are used fitted with a KS0070B or HD44780UA IC as an LCD controller.

As already mentioned, the display is initialised with the 28H command, where 20H represents initialisation in 4-bit mode and the fourth bit (with

bit numbering 1-8) selects the 2-line mode if it is set high. Based on my research, the 4/8-bit display first needs an 8-bit 20H initialisation command to place it in 4-bit mode. After this, the command for the 2-line mode (28H) can be transferred using two half-byte commands (since the lower four bits of the display are tied to ground). Consequently, all the program has to do is to issue a 20H command as a 1-byte command before it issues the 28H command.

The instruction (see box), which is located in the main .c routine, calls the initialisation routine LCD.C.

However, these changes can only be implemented if the microcontroller has a programming interface (see photo) so the program can be modified. The JTAG interface is described in Section 4.4 (Data Interface) of the data sheet for the ST7MC1/ST7MC. A JTAG interface such as inDART from SofTec Microsystems (www.softecmicro.com/products.html?type=browse&title=ISP+Debuggers/+Programmers) can then be used to reprogram the microcontroller.

Jürgen Rieger (Germany)

MailBox Terms

- Publication of reader's correspondence is at the discretion of the Editor.
 - Viewpoints expressed by correspondents are not necessarily those of the Editor or Publisher.
 - Correspondence may be translated or edited for length, clarity and style.
- When replying to MailBox correspondence, please quote Issue number.
- Please send your MailBox correspondence to:

editor@elektor.com or
Elektor, The Editor,
1000 Great West Road,
Brenford TW8 9HH, England.

Two-channel 120-W Class D audio amp reference design

International Rectifier introduced the IRAUDAMP4 Class D audio power amplifier reference design. Compared to typical circuit designs, the new reference design illustrates how designers can reduce PCB board space by 50 percent for Class D audio amplifiers for the entire mid-voltage range of mid- and high-power amplifiers for home theatre applications, professional amplifiers, musical instruments and car entertainment.

Showcasing IR's IRS20955 200-V digital audio driver IC and the IRF6645 DirectFET® digital audio MOSFETs, the IRAUDAMP4 reference design is a two-channel, 120 W half-bridge design offering 96% efficiency at 120 W, four ohms. The design incorporates critical protection features such as over-current protection, over-voltage protection, under-voltage protection, DC-protection, and over-temperature protection, in addition to housekeeping functions such as a ± 5 V supply for analog



signal processing for the pre-amplifier and a +12V supply (Vcc) referenced to -B for the Class D gate driver stage. The two-channel design is scalable for power and number of channels, and requires no heatsink under normal operating conditions.

The IRS20955(S)(TR)PbF audio driver IC, on which the reference design is based, features a floating PWM input designed specifically for Class D audio amplifier applications. Bi-directional current sensing detects over-current conditions during positive and negative load currents without any external shunt

resistors. A built-in protection control block provides a secure protection sequence against over-current conditions and a programmable reset timer. The internal deadtime generation block enables accurate gate switching and optimum dead-time setting for better audio performance, such as lower THD and lower audio noise floor. The featured companion IRF6645 power MOSFETs are part of IR's DirectFET family. The innovative DirectFET packaging technology enhances performance in Class D audio amplifier circuits by reducing lead inductance to improve switching performance and reduce EMI noise. The higher thermal efficiency enables 120 W operation into four-ohms, eliminating the need for a heatsink to shrink circuit size, provide greater layout flexibility and reduce overall amplifier system cost.

www.irf.com

(070679-VI)

Semiconductor Wiki

Microchip announces ICwiki — a website that enables engineers to collaborate and share information related to semiconductor products, applications and best practices. Using Wiki technology, participants can change content on the site and participate in web logging ('blogging'), voting and messaging. ICWiki is available in several different languages, including English, Chinese, Japanese, French, German, Italian, Portuguese, Russian and Spanish.

Following recent trends toward online social networking, ICwiki was designed to help engineers share knowledge about designs and applications, as well as helping university students gain access to knowledge that can help bridge



their transition from academia to industry. Participants can work together in either public or private blogs via the site's Group Decision Support Systems (GDSS) feature.

Subject areas on the new Wiki include particular market areas such as automotive, home appliances and robotics; functional topics such as algorithms, oscillators, PCB lay-

out best practices and signal conditioning; and product topics such as microcontrollers, Digital Signal Controllers (DSCs), analogue and memory products.

The new ICwiki, whilst promoting links between academia and industry, also forms an important part of the 'University of Microchip'. This is Microchip's education and training program, not only supporting universities all around the world, but also encompassing training provision in Regional Training Centers (RTCs) worldwide, at Microchip's MASTERs conferences and in online De-

sign Centers.

www.microchip.com/ICwiki

(070679-VIII)

Environmentally friendly alternative to ionisation detectors

In response to the trend for an increasing number of modern materials to generate a fast, flaming fire, System Sensor Europe extends its product portfolio of high performance addressable fire detectors with the introduction of PTIR; the Photo Thermal Infra-Red detector. PTIR has been developed specifically to provide an efficient and environmentally benign alternative to the venerable ionisation detector, a 60-year-old technology. Until the introduction of the PTIR, ionisation technology was the most responsive and stable detector available for the rapid detection of fast flaming fires; however, it contains small amounts of radioactive material, so manufacturing, transport and end of life disposal costs have rightly in-



creased in response to environmental concerns. Indeed, many countries now forbid their use completely and the great majority will only approve their use when an effective alternative is not available. PTIR consists of independent photo-electric, thermal and infrared sen-

sors, managed and controlled by sophisticated algorithms running on an embedded processor. The addition of the IR sensor to the established photo-thermal multi-sensor design increases the unit's performance to the point where it can be used to replace the environmentally

unfriendly ionisation detector without degradation in speed of response or increased false alarm frequency. PTIR, in common with all System Sensor devices, is an environmentally friendly detector, meeting the WEEE and RoHS legislative requirements even though they are not mandatory in the fixed installation fire industry. By not using any environmentally hazardous materials, the widespread adoption of the PTIR as a high performance replacement for the ionisation detector will immediately reduce the amount of hazardous material contaminating an increasingly fragile world.

www.systemsensoreurope.com

(070679-IX)

Fanless PanelPC for embedded applications

For use in embedded applications such as machine control panels, parking ticket machines, kiosks, mobile and marine applications and advertising displays, BVM has introduced the OPC-363-84, a cost-effective fanless PanelPC complete with an 8.4" touch screen and VGA display. The standard unit uses four-wire touch screen technology with an optional heavy duty capacitive touch-screen available for systems designed to be operated by the public. The standard unit is configured around an AMD Geode GX533 CPU with an LVDS connection

to the 800x600 LCD panel. This produces 262 kcolours at a contrast ratio of 500:1 and a brightness of 450 cd/sqm making it ideal for use in many different environments.

The PC has up to 512 MB of RAM and an on-board VGA controller, which can be used to drive a second display, audio and dual LAN interfaces. A laptop style 40 GB HDD installed as standard can be substituted for a solid state device if required. Alternatively the CompactFlash socket can be used as the storage medium. An on-board Mini-PCI site and PCMCIA socket

can provide a wireless LAN or other specialised interfaces. The OPC-363-84 is powered from 12 VDC with power consumption is a miserly 10 W and no forced cooling is required. The optional rear cover adds EMC shielding and protection from damage and has the facility to house a cooling fan for high ambient temperature applications. Two RJ45 LAN ports, one CRT port,



a PS/2 keyboard/mouse port and a D-sub and DC-min ports are provided for external connection at the base of the unit.

www.bvmltd.co.uk

(070679-X)



Displays for Temposonics C-Series Sensors

designed specifically for use with MTS' C-Series sensors. Designated the TDD-C4 and the TDD-C32, the displays supply power to the C-Series sensors, include cabling that is compatible, and provide engineering unit output in inches and millimeters.

The 4-digit TDD-C4 display supports PWM and analog sensors with an option to automatically detect type. It provides 90 counts per inch base resolution for PWM (enhanced to 360 counts per inch by averaging) and 983 counts per sensor in analog mode. Features include a selectable units switch,

3 DC inputs for set-up and operation, and asynchronous serial communications.

Like the TDD-C4, the 4-digit TDD-C32 display supports PWM and analog sensors with an option to automatically detect type, and provides 90 counts per inch base resolution for PWM (enhanced to 360 counts per inch by averaging) and 983 counts per sensor in analog mode. Features include DC input for Zero, optional set-up via serial or 2-switch keypad, a selectable units switch and asynchronous serial communications.

The compact size, zero wear, zero recalibration and optimized cost of the C-Series Core sensor makes it an ideal choice to replace older technology sensors, such as linear potentiometers and LVDTs. The C-Series sensor brings immediate benefits to the customer, including lower costs due to the elimination of expensive signal conditioning and higher reliability due to the non-contact nature of magnetostrictive sensor technology.

www.mtssensors.com
www.rapidcontrols.com

(070723-1)

Industry's smallest 8051-based micro for mobile devices

SST announced a new addition to the company's popular SuperFlash-based FlashFlex family of 8-bit, 8051-compatible microcontrollers, the SST89V54RD-33-C-Q1F. The new SST89V54RD is available in a 6x6 mm WQFN package, making it the smallest 8051-based microcontroller currently on the market. The device's miniature size and low power consumption are ideal for small form factor mobile applications, such as notebook PCs, MP3 players and GPS systems, as well as home entertainment devices including HDMI products. Additionally, the SST89V54RD supports in-system programming (ISP) and

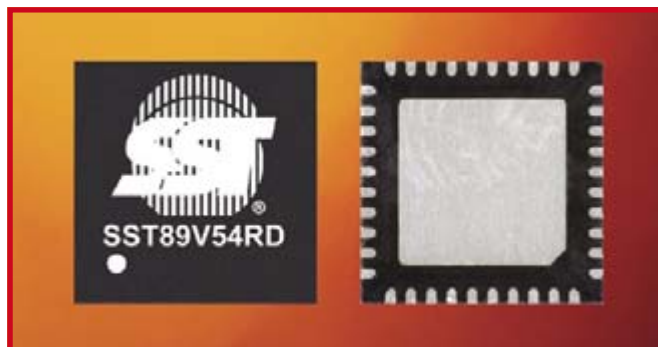

in-application programming (IAP), which provide a variety of benefits to device manufacturers and consumers alike.

In addition to a tiny 6x6 mm

footprint, the WQFN package offers an extremely low-profile nominal package height of only 0.7 mm (maximum total thickness of 0.8 mm), making the new SST-

89V54RD well suited for height-constrained mobile applications. The SST89V54RD supports both IAP and ISP, enabling the user to update the flash device in the field or in an application. Both IAP and ISP lower cost and improve time-to-market for manufacturers, while bringing enhanced user experiences and convenience to consumers. These re-programming features also have a significant role in enabling increased functionality, such as remote diagnostics and product monitoring, in network- or Internet-enabled devices.

www.sst.com

(070723-II)

Cypress PSoC FirstTouch kit Comes In USB thumbdrive format

Cypress Semiconductor Corp. recently introduced their PSoC[®] FirstTouch[™] Starter Kit, a USB thumbdrive kit that provides a quick, easy, and affordable way for embedded customers to evaluate the integration, flexibility, and real mixed-signal programmability of PSoC mixed-signal arrays.

Without writing or debugging a single line of C or Assembly code, the PSoC FirstTouch Starter Kit, working with Cypress's PSoC Express[™] visual embedded system design tool, provides designers with CapSense touch, temperature, light and CapSense proximity sensing right out of the box. Customers can also experiment with many more designs available on www.cypress.com/go/firsttouch, or build their own in minutes via PSoC Express. They can also add all of this functionality directly to their own development systems via the detachable expansion card.

The PSoC FirstTouch Starter Kit includes two small boards – a main system board that interfaces with a computer over USB, and a detachable multifunction expansion card.



The expansion card includes inputs and outputs for the many applications supported by the kit. No other thumbdrive kit offers such an extensive array of applications. The PSoC FirstTouch Starter Kit delivers an extensive list of features, including:

- Four embedded designs right out of the box
- No code, no debugging PSoC Express-based design platform
- 16-pin connection interface to plug the multifunction expansion card into target boards
- Pins accessible for user functions
- Convenient, USB thumb drive format
- I²C and I²S support

The PSoC FirstTouch Starter Kit is available from the Online Store on the Cypress website at www.cypress.com/go/firsttouch and from Cypress's distribution partners worldwide. The kit is priced at US\$29.95.

www.cypress.com/go/firsttouch

(070723-III)

Linux driver for USB TC-08 thermocouple data logger

Due to strong customer demand, Pico Technology has released a beta version of a Linux driver to allow programmers to control the

USB TC-08 using their own software. As Linux is widely used in educational and scientific computing, and is open-source and avail-

able free of charge, this driver is expected to open up a range of new applications for low-cost, accurate temperature data-logging.

The USB TC-08 is an eight-channel thermocouple data logger with a USB interface. It is packaged in a robust, compact case and draws

its power from the USB cable, so it requires no external power supply. It has standard thermocouple connectors that accept all common thermocouple types (B, E, J, K, N, R, S, T) allowing you to measure temperatures in the range -270 to

+1820 degrees Celsius with up to 0.5 degree accuracy. The TC-08 has automatic cold-junction compensation, and conversion time is 100 milliseconds per channel. The driver is supplied in source-code form to allow compatibility

with the widest possible range of Linux systems, and is accompanied by example programs in C and C++. It is released under an Open Source licence which allows it to be modified and redistributed. Please note that this beta release

is not fully tested. It can be downloaded from the link below. All drivers and documentation from Pico are free of charge.

<http://labs.picotech.com>

(070723-IV)

Semiconductor start-up premières breakthrough sensor technology

ChipSensors Ltd, a fabless semiconductor start-up company, has unveiled a breakthrough in semiconductor technology that enables the surface of the chip itself to sense parameters such as temperature, humidity, certain gases and pathogens. The patent-pending technology exploits the fact that the dielectric material in standard sub-micron CMOS comprises porous oxides and polymers; by selectively admitting or blocking ingress of the agent to be sensed, any resulting changes in electrical characteristics can be accurately detected and measured.

The sensor technology is being shown in public for the first time at the RFID Europe 2007 exhibition in Cambridge. Visitors to booth 17 will be able to see a working demonstration of a prototype single-chip temperature and humidity sensor, communicating via an off-chip wireless link to a laptop PC displaying real-time measurements. The 0.13 µm sensor chip being shown at RFID Europe has obvious

applications as an all-electronic replacement for the type of electromechanical thermostats and humidistats used in building manage-

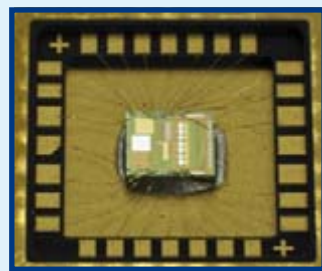

ment and environmental monitoring systems. ChipSensors is also currently developing an ultra-low-power wireless version of this sensor - which integrates all the signal conditioning, microcontroller, memory and RF transceiver functions onto the same chip as the sensor itself — for incorporation into passive and active ID tags.

ChipSensors Ltd was founded in 2006, as a spin-out from a design consultancy that specialises in wireless sensors. Initially self-funded, with matching grants and equity from various government agencies, the company attracted sufficient venture capital to seed development of its innovative sili-

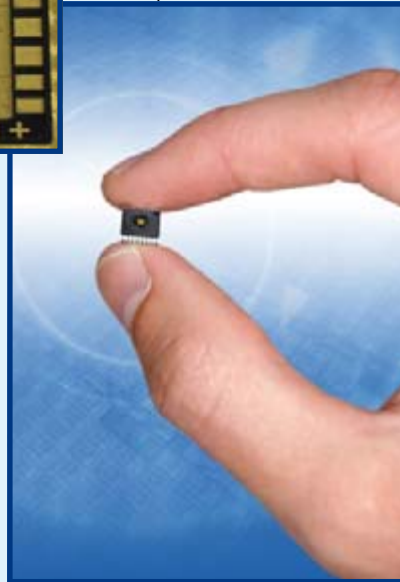

con sensors. ChipSensors is now on the verge of commercialising this technology, and is currently engaged in negotiations with international customers, partners and potential investors. Until now, most sensors have been manufactured on glass or ceramic substrates, using specialist materials and manufacturing processes, and have proved difficult, if not impossible, to accommodate within mainstream foundry CMOS processes. The wafers had to be post-processed and the sensors then required testing and calibrating after packaging, which was time-consuming and expensive. ChipSensors' proprietary technology overcomes these obstacles. It enables sensors, signal conditioning circuits — including high resolution analog-to-digital converters — and RF transceiver functions, together with the microcontroller and memory, to be integrated on a single chip, fabricated entirely from standard CMOS.

www.chipsensors.com.

(070723-VIII)

Enhanced GPS integration with gyroscope in dead reckoning reference design

u-blox has improved its groundbreaking GPS dead reckoning system by integrating a gyroscope sensor from Epson Toyocom, a leader in the design and manufacture of crystal-based electronic products, into the reference design for the product. The reference design will shorten time-to-market and reduce the risk of GPS integration for applications that require accurate, uninterrupted positioning regardless of GPS signal conditions. u-blox' dead reckoning solution, powered by the LEA-4R dead reckoning GPS module, is ideal for applications that require continuous positioning such as vehicle navigation, fleet management and toll systems. An odometer calculates di-



stance traveled and a gyroscope determines turn rate. This data supplements the GPS data to provide continuous positioning in tunnels, indoor parking facilities, urban canyons and other environments in which it may be difficult to obtain a GPS satellite signal. The AEK-4R dead reckoning reference design Evaluation Kit is available from October from u-blox official distributors and from u-blox' online shop at the link below. The reference design schematics are available upon request. Please contact sales@u-blox.com for details.

www.u-blox.com/shop/

(070723-VI)

Microchip PIC Boards

Embedded webserver
USB, Ethernet
Dallas 1-wire
RS232/185, I2C
CAN-BUS
Serial LCD

Free project download
with source code



ARM Development Boards

High performance 32bit RISC
USB JTAG
Ethernet and USB
RS233, I2C, CAN-BUS
NXP LPC and Atmel SAM

Free C compiler and IDE
Free ARM7 tutorial download



Embedded Linux Boards

Low cost embedded Linux board
Two USB host interface
Two 40 pins sockets for
expansion
GSM / GPS Module add on
Create CGI using C language
Apache, PHP and SQLite
RSS Reader and LCD demo

Free SDK compiler download

Secure online ordering

www.skpang.co.uk

sales@skpang.co.uk



cleverscope plug & play instruments

why is everyone talking
about cleverscope?



cleverscope CS328A

visit our website and
discover for yourself

www.cleverscope.com

** quote: "I've got one for work and one for home - I
recommend it to my friends"*

mixed signal oscilloscope and spectrum analyser

№1 Number One Systems

Easy-PC for Windows

The World Beating PCB design software

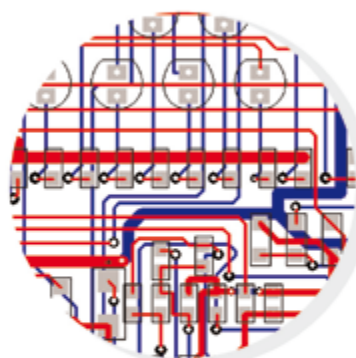

Version 11 features

- Design revision analysis
 - Star/Delta points
 - Apply layout pattern & groups
 - Design calculators
 - Electrical rules check (ERC)
 - Shape editing panel
 - Merge/subtract shape editing
 - Track analysis
- Plus many more exciting features...

The new Easy-PC reaches even higher!

The breathtaking new Easy-PC for Windows Version 11 is released. Winning accolades the world over, V11 of the market leading Easy-PC delivers even more remarkable value for money and sets the new benchmark for performance in PCB CAD.

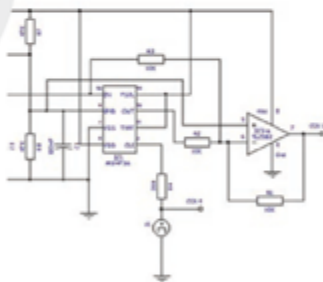

Just try a demonstration copy of Easy-PC and prepare to be amazed...

Easy-PC delivers a simple to understand, fully integrated Schematics & PCB layout in a single application. Design and rules checks at all stages ensure integrity at all times. Professional manufacturing outputs allow you to finish the design process with ease.

Stop press... Stop press... Stop press...
Easy-PC is supported running under Windows Vista

STILL FROM ONLY
£247
PLUS VAT

Call for a brochure, prices & CD on +44 (0)1684 773662
or e-mail sales@numberone.com
you can also download a demo from

www.NumberOne.com

Oak Lane, Bredon, Tewkesbury, Glos. GL20 7LR. United Kingdom



Helping You Succeed

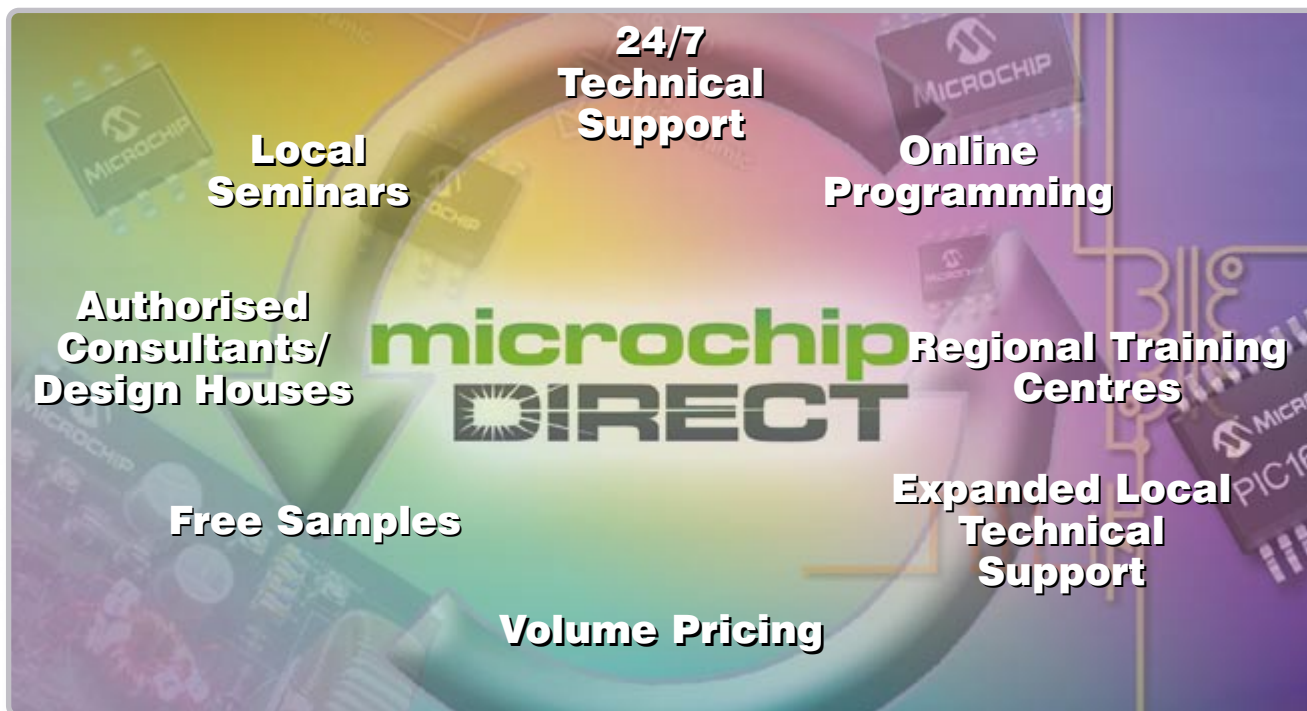

Does your business need more support and resources?

Successful organizations recognize the value of a strategic supplier relationship to help them deliver innovative products to their markets in a timely and cost-effective manner. Microchip Technology supports more than 45,000 customers worldwide, and we're

committed to helping you succeed. In addition to our high-performance silicon solutions, Microchip provides a long list of support functions that reduce time to market and lower your total system cost. And we have significantly expanded our local technical resources.

Use microchipDIRECT to:

Register today!



- Order directly from Microchip, 24 hours a day, 7 days a week with a credit card or credit line
- Receive competitive, direct volume pricing on all devices
- Check our product inventory
- Order broken reels at steep discounts
- Use fast and inexpensive production programming (now available)
- Place and maintain your order securely from any network connection
- Assign a PO number to your order
- Create a unique part number for any item ordered
- Receive e-mail notification of orders, deliveries, quote status and more

microchip
DIRECT
www.microchipdirect.com

Now
Pb-free!
RoHS Compliant

 **MICROCHIP**
www.microchip.com

USB Data Acquisition

José Luis Rupérez Fombellida

This data acquisition card for connection to the USB has eight digital outputs, eight digital inputs, two 10-bit analogue outputs and eight 10-bit analogue inputs for voltage swings of 0 to 5 V. The system's core is a Microchip USB-savvy microcontroller type PIC18F4550 programmed in C. The circuit is built on a compact PCB and requires no external power supply.

Measurement cards and systems you can connect to a PC have been a constant success factor in the long history of *Elektor*. Whether it's stand-alone for control over the RS232 or LPT ports (anyone remember those?), as a plug-in card for the ISA bus (*ditto*) or now, recently, for the USB, it's a blockbuster if our readers can (1) generate and read digital control signals, and (2) do the same for analogue signals! The card described in this article could be at the hub of a great many applications to do with measurement and control.

We want USB

Arguably, RS232, ISA and even Centronics are things of the past when it comes to digital and analogue signals specifically for measurement and control by/on a PC. USB is the way forward both in terms of speed and ease of connection, although the latter is a complex matter especially as far as software is concerned. For example, a lot of thought (and time) goes into making

the PC recognise a valid USB device! In this article hopefully we cater for readers only interested in digital and analogue connectivity with the real world, as well as for those with a deeper interest in how USB actually works on a microcontroller and, equally important, can be made to do something really useful — all at very low cost, of course.

PIC 18F4550 for USB

Fortunately, there are microcontrollers that make the USB interface between the PC (the host) and the circuit we wish to design (the device) more or less transparent. That's because they are provided with dedicated hardware and software to implement USB 'the easy way'. All totally invisible of course to those who just want to use the USB device yet know nothing about it (which should not include you)! One such processor is Microchip's PIC 18F4550, which has the additional advantage of lots of (free) software being available for it. Also, the device is available as a

DIP40 device which should attract applause and other expressions of approval from the *I-hate-SMDs* camp.

The circuit

The circuit diagram of this small wonder of technology is given in **Figure 1**. It's not much more than a powerful CPU (IC1) surrounded by input and output connectors and a few status LEDs. The function of the connectors is as follows, with the relevant PIC lines in brackets:

- K1** = 8-bit digital output for 0-5 V TTL swing (RD0-RD7).
- K2** = USB connector for linking to your PC (RC4-RC5).
- K3** = 8-bit digital input for 0-5 V TTL swing (RB0-RB7).
- K4** = two analogue outputs for 0-5 V swing (RC1-RC2).
- K5** = 8 analogue inputs (AN0/

digital & analogue; input & output

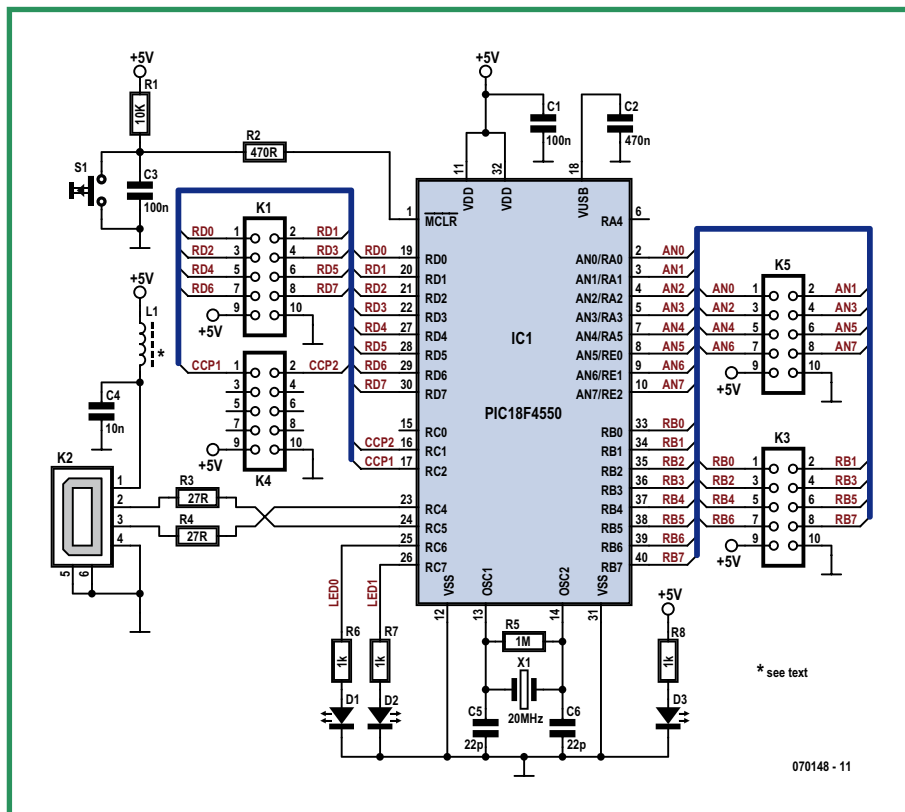

Figure 1. Circuit diagram of the data acquisition card with USB connectivity.

RA0-AN7/RE2) for 0-5 V swing.

Internal pull-up resistors are available on RB, the digital input port lines. The analogue outputs have a resolution of 10 bits each using PWM (pulsewidth modulation) at 2.9 kHz. If necessary these outputs can be filtered with a simple RC network. The DC output voltage V_o obtained after the filtering may be calculated from:

$$V_o = 5D \text{ [volts]}$$

where variable D is the duty cycle of the PWM, taking a value between 0 and 1.

The analogue inputs also have a resolution of 10 bits.

The oscillator in the PIC micro ticks at 20 MHz using quartz crystal X1 and the usual pair of small capacitors for the parallel loading, and a high-value resistor (R5) for the feedback. Actually the microcontroller runs at 48 MHz, generated internally with

the aid of a PLL and a frequency divider from the 20 MHz supplied by the quartz crystal. The frequency of 48 MHz is an exact multiple of the USB bus speed (full speed, 12 Mbits/s).

Two status LEDs, D1 and D2, indicate the USB status. D3 is obviously the supply power indicator that lights when the card is connected to the USB port on your PC.

The circuit's supply voltage arrives via USB connector K2 and a small choke, L1, to suppress noise, with C4 assisting to that effect.

That effectively leaves components S1, R1, R2 and C3 at the $\overline{\text{MCLR}}$ input of the micro. Well it's just another wholly traditional Reset network.

PIC Firmware

Where there's simple hardware, there's a massive amount of software behind it all and usually lurking inside microcontrollers. The firmware (object code) the PIC is faithfully executing was created

by the author using two free software tools from Microchip: IDE MPLAB V7.5 and C18 Student Edition V3.02. The Microchip website has instructions for installation and use of both programs. The source code of the firmware is different from the Microchip original. All project software is available as a free download # **070148-11.zip** from our website at www.elektor.com. You will find at least three folders in the archive file: 'driver', 'firmware' and 'PC'. The content is an Aladdin's Cave for fans of C, PICs and USB (and that should cover a lot of our readers!). A piece of C code is shown in **Figure 2**; it's these PIC fuse settings you'll need to know if you're not buying the chip ready-programmed from Elektor.

The firmware file contains the whole project and the result of its compilation called TAD_v1.hex. The microcontroller must be programmed with this file. Those of you interested in the deeper workings of USB should know that the connectivity implemented on the card described on this article is de-

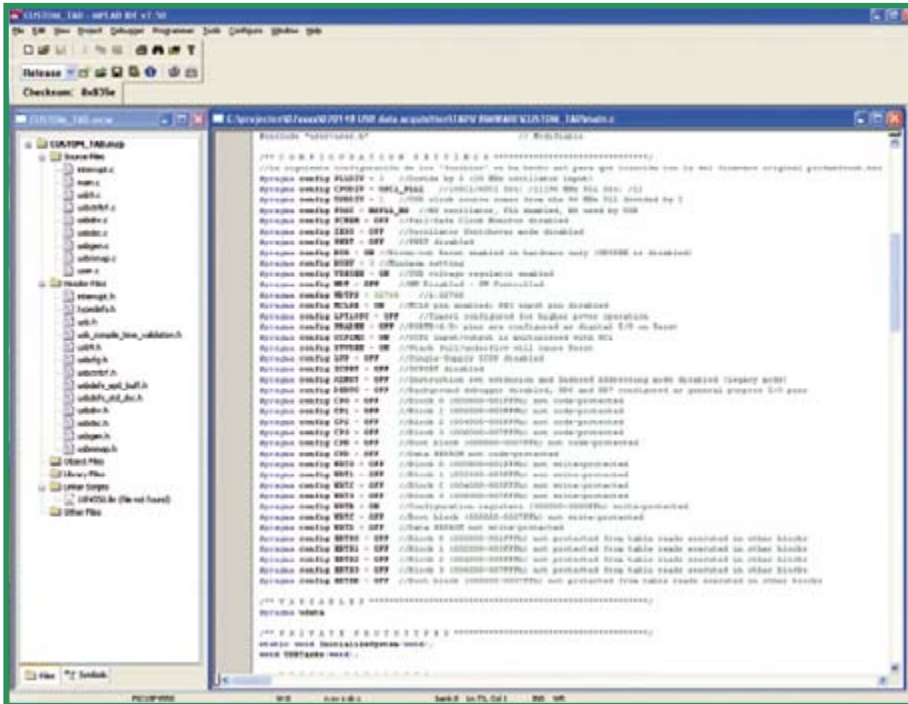

Figure 2. RU on MPLAB too? Lots of Elektor readers are. The C code for the project also contains useful information on the PIC fuse settings — an ongoing source of confusion to many microcontroller enthusiasts (and not just those on PIC).

fined by firmware in the PIC18F4550. The following building blocks are used: BUS POWER MODE; CUSTOM CLASS; FULL-SPEED (12 MBIT/S) and INTERRUPT TRANSFER.

Construction

The circuit is built on a compact double-sided printed circuit board of

which the component placement at both sides is shown in Figure 3. Some empty space has been left at the short sides of the board be able to secure it with screws.

Although building up the board will be mostly plain sailing for experienced readers, some remarks may be in order for those just starting out in USB land with the present card.

The opening in the collar of each box-header is an orientation aid and should be at the edge of the board to enable an IDC connector on a flatcable to be plugged in.

SMD components are fitted at both sides of the board, so carefully study the two overlays to establish the correct position and of each part, as well as the orientation in the case of the SMD LEDs.

We recommend fitting the programmed PIC18F4550 in a good quality 40-way DIL socket. Watch the orientation of the large IC: pin 1 is near the reset switch S1.

L1, finally, is a ferrite bead with three or four holes through which a piece of enamelled or other stiff wire is pulled. A ferrite bead with one hole and three turns of wire through it should also work. The final inductance of the RF choke so made is uncritical.

To avoid possible damage to the PC, verify that there are no short circuits or other problems in the pins of USB connector K2.

First connection

Once the card is fully populated (and the microcontroller properly programmed), connect it to a PC by means of a standard USB cable. The power LED D3 lights and one of the LEDs D1 and D2 flashes while the other remains off. At the same time the PC will tell you that a new USB device has been connected and that a driver is required. Tell Windows where the driver is located (folder driver\mchpush.inf). Once the driver is installed the USB status LEDs flash alternatively. The card is then ready for use.

VID/PID (Product ID/Vendor ID)

All USB devices have a unique combination consisting of two numbers so that no two equal devices exist. The first number, VID, identifies the manufacturer of the device and the second, PID, gives the product identifier. The combination used in this project uses as VID the one of Microchip and

Data acquisition card trainer bench

The author has developed four simple add-on cards for testing the data acquisition card for the following functionalities:

1. LED card: 8 LEDs to visualize the digital output.
2. Pushbutton and switch card: 4 pushbuttons and 4 switches to exercise the 8 digital inputs.
3. LED voltmeter card: two LEDs that change their brightness according to the two analogue outputs.
4. Potentiometer card: 8 potentiometers for testing correct operation of the 8 analogue inputs.

The data acquisition card and the four cards are shown in the picture. Although PCBs are shown and the author has the schematics and board designs in OrCAD format, these cards should be easy to build using Vero board.

To test the whole system, a program was developed in C++ CLR, for which the (free) Visual C++ 2005 Express compiler was used. This program is based on examples from Microchip.

A screendump of the program is shown here. This software is included in the archive file for the project.

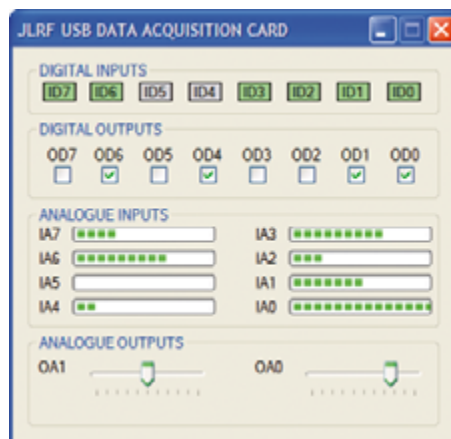

as PID the one of a demo card of the PIC18F4550 Microchip. If the USB Data Acquisition Card is used for commercial purposes, it is essential to obtain a different VID/PID set of numbers—this can be done, for example, through www.usb.org or through Microchip.

This new combination should be included in the source code of firmware that would be compiled again in order to obtain an updated .hex file with which the microcontroller is programmed.

The PC software would also have to be modified in the same way, since firmware and software must have the same VID/PID. Finally, the driver 'mchpushb.inf' file would be modified.

Precautions

Some general precautions must be mentioned. All expansion connectors K1, K3, K4 and K5 include +5 V and ground to power any cards that can be connected to them. Great care must be taken to prevent short circuiting these terminals and not drawing more than 100 mA from any of them. Also, remember that these terminals are directly connected to the +5 V and ground of the USB port of your computer (and you do not want that to take damage

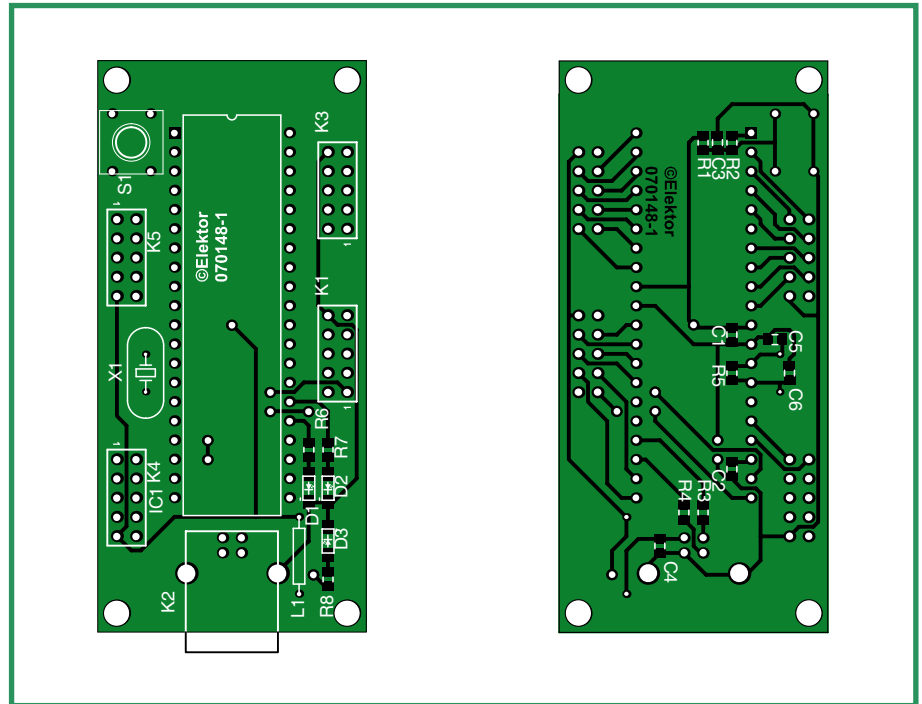

Figure 3. Top side and bottom side component placement for the PCB. The PCB artwork is a free pdf download from our website but bear in mind that the board is double-sided and through-plated.

— avoid using family or kiddies PCs in any case).

If you need more current for a certain application, consider the use of an ex-

ternal power supply, joining only application and USB Data Acquisition Card grounds.

Some precautions for the digital inputs

COMPONENTS LIST

Resistors

(all SMD 0805 case)

R1 = 10k Ω

R2 = 470 Ω

R3,R4 = 33 Ω

R5 = 1M Ω

R6,R7,R8 = 1k Ω

Capacitors

(all SMD 0805 case)

C1,C3 = 100nF

C2 = 470nF

C4 = 10nF

C5,C6 = 22pF

Semiconductors

IC1 = PIC18F4550 I/P, programmed, Elektor Shop # **070148-41**

D1,D2,D3 = LED, SMD case 1206

Miscellaneous

K1,K3,K4,K5 = 10-way boxheader

K2 = type-B USB connector, PCB mount

X1 = 20MHz quartz crystal

L1 = VK200 or small ferrite bead with 2-4 turns thin enamelled copper wire

S1 = pushbutton, PCB mount, 6mm footprint

DIL40 socket for IC1

PCB (bare), Elektor Shop # **070148-1**

Project software, file # **070148-11**, free download from www.elektor.com.



Files & file locations

The complete project of the application for the PC is in PC\TAD_V1_win\ folder and its name is TAD_V1_win.vcproj. The compiled program is in PC\TAD_V1_win\Release folder and its name is TAD_V1_win.exe (for the program to work, the dynamic link library mpusbapi.dll created by Microchip must be in that same folder). The executable one needs the .NET Framework. It is highly recommended to have the operating system updated by means of Windows Update.

If you wish to modify the project to adapt it to your requirements it is necessary to install the Visual compiler Microsoft C++ 2005 Express and update it with Service Pack 1: Visual C++ 2005 Express SP1. Later we will install Microsoft Platform SDK for Microsoft Visual C++ 2005 Express. This serves to develop WIN32 applications, necessary in this case to access the DLL mpusbapi.dll). All of it is free and can be downloaded from the Microsoft website. There you will also find instructions about installation and examples.

(K3): Do not apply voltages below zero or higher than 5 volts to avoid damage to the PIC microcontroller.
 On the digital outputs (K1): each line can supply a maximum current of 25 mA for logic High or Low levels.
 On the analogue inputs (K5); the same as with the digital inputs.
 On the analogue outputs (K4): each line can supply a maximum current of 25 mA for logic High and Low levels of the PWM signal.
 Finally, the sum of all currents of all the digital and analogue outputs must not exceed 200 mA.

Work in progress...

The USB data acquisition data card has a lot of potential and the author has developed, and is busy developing, the following application cards:

1. Triac card for the 8 digital outputs, to be able to control mains-powered loads

- in a comfortable manner. This card is isolated using optotriacs.
- 2. Resistor-to-voltage converter card supplying a voltage proportional to the input resistor. This voltage is applied to the digital input.
- 3. Voltmeter card with LED bar readout.
- 4. Speed control of a DC motor. This card controls the speed and direction of a motor through the analogue outputs.
- 5. Driver card for stepper motors, capable of microstepping through the digital outputs.
- 6. Distance sensors card using the analogue inputs.
- 7. Relay card under control of the digital outputs.

Elektor and the author welcome other applications you may have developed. Let us know!

(070148-1)

About the author

The author is a telecommunications technical engineer working as a teacher of electronics in a professional school in Madrid since 1984. He is a keen electronics enthusiast. He developed this card to enable his students to control small robots from the USB port in a PC by programmes written in C code.



Follow these steps

The PC software available for this project should be relatively easy to install use and/or adapt if you follow these steps.

1. **Install Visual C++ 2005 Express:**
<http://msdn2.microsoft.com/en-us/express/aa975050.aspx>
2. **Install Visual C++ 2005 Express SP1:**
<http://msdn2.microsoft.com/en-us/express/aa975050.aspx>
3. **Install PSDK: Microsoft Platform SDK for Microsoft Visual C++ 2005 Express:**
<http://msdn2.microsoft.com/en-us/express/aa975050.aspx>
4. **Update the operating system using Windows Update.**
5. **Tell Visual C++ to use PSDK.**

The sequence to do so suggested by Microsoft is given below.

- 5.1 **Update the Visual C++ directories in the Projects and Solutions section in the Options dialogue box.**
Add the paths to the appropriate subsection:
 Executable files: C:\Program Files\Microsoft Platform SDK for Windows Server 2003 R2\Bin;
 Include files: C:\Program Files\Microsoft Platform SDK for Windows Server 2003 R2\Include;
 Library files: C:\Program Files\Microsoft Platform SDK for Windows Server 2003 R2\Lib.

5.2. Update the corewin_express.vsprops file.

One more step is needed to make the Win32 template work in Visual C++ Express. You need to edit the corewin_express.vsprops file (found in C:\Program Files\Microsoft Visual Studio 8\VC\VCProjectDefaults) and change the string that reads:

AdditionalDependencies="kernel32.lib" to:

AdditionalDependencies="kernel32.lib user32.lib gdi32.lib winspool.lib comdlg32.lib advapi32.lib shell32.lib ole32.lib oleaut32.lib uuid.lib".

5.3. Generate and build a Win32 application to test your paths.

In Visual C++ Express, the Win32 Windows Application type is disabled in the Win32 Application Wizard. To enable that type, you need to edit the file AppSettings.htm file located in the folder "%ProgramFiles%\Microsoft Visual Studio 8\VC\VCWizards\AppWiz\Generic\Application\html\1033\".

In a text editor, comment out lines 441 - 444 by putting a // (double slash forward) in front of them as shown here:

```
// WIN_APP.disabled = true;
// WIN_APP_LABEL.disabled = true;
// DLL_APP.disabled = true;
// DLL_APP_LABEL.disabled = true.
```

Save and close the file and open Visual C++ Express.



CAN-1 Board - Interface CAN via MCP2551.
CANSPI Board - Make CAN network with SPI interface.
RS485 Board - Connect devices into RS-485 network.
Serial Ethernet - Make ethernet network with SPI Interface (ENC28J60).
IrDA2 Board - Irda2 serve as wireless RS232 communication between two MCU's.



CF Board - Easy way to use Compact flash in your design.
MMC/SD Board - Easy way to use MMC and SD cards in your design.
EEPROM Board - Serial EEPROM board via I2C interface.
RTC Board - PCF8583 RTC with battery backup.



ADC Board - 12-bit analog-to-digital converter (ADC) with 4 inputs.
DAC Board - 12-bit digital-to-analog converter (DAC) with SPI.
Keypad 4x4 Board - Add keypad to your application.
Accel. Board - Accel. is an electronic device that measures acceleration forces.



PICFlash programmer - an ultra fast USB 2.0 programmer for the PIC microcontrollers. Continuing its tradition as one of the fastest PIC programmer on the market, a new PICFlash with mikroCD now supports more PIC MCUs giving developer a wider choice of PIC MCU for further prototype development.
mikroCD debugger enables you to execute mikroC / mikroPascal / mikroBasic programs on the host PIC microcontroller and view variable values, Special Function Registers (SFR), memory and EEPROM while the program is running.

- All of our products are shipped in special protective boxes.
- On-line secure ordering provides fast and safe way of buying our products.

EasyPIC4 Development Board

Complete Hardware and Software solution with on-board USB 2.0 programmer and mikroCD



Following tradition of its predecessor EasyPIC3 as one of the best PIC development systems on the market, EasyPIC4 has more new features for the same price. The system supports 8-, 14, 18, 20, 28, and 40 pin PIC microcontrollers (it comes with a PIC18F877A). **USB 2.0 on-board programmer with mikroCD (In-Circuit Debugger)** enables very efficient debugging and faster prototype development. Examples in **C, BASIC and Pascal** language are provided with the board.

LV24-33 Development Board

Complete Hardware and Software solution with on-board USB 2.0 programmer and mikroCD



System supports 64, 80 and 100 pins **PIC24F/24H/dsPIC33F** microcontrollers (it comes with PIC24FJ96GA010 - PIC24 16-bit Microcontroller, 96 KB Flash Memory, 8 KB RAM in 100 Pin Package). Examples in **BASIC, PASCAL and C** are included with (in) the system. You can choose between USB and External Power supply. **LV 24-33** has many features that make your development easy. **USB 2.0 on-board programmer with mikroCD (In-Circuit Debugger)** enables very efficient debugging and faster prototype development.

PICPLC16B Development Board

Complete Hardware and Software solution with on-board USB 2.0 programmer and mikroCD



PICPLC16B is a system designed for controlling industrial systems and machines. 16 inputs with **optocouplers** and 16 relays (up to 10A) can satisfy many industrial needs. The ultra fast **mikroCD (In-Circuit Debugger)** enables very efficient debugging and faster prototype development. Features: **RS485, RS232, Serial Ethernet, USB 2.0 on-board programmer and mikroCD (In-Circuit Debugger)** on-board.

mikroElektronika Compilers

Pascal, Basic and C Compilers for various microcontrollers



Supporting an impressive range of microcontrollers, an easy-to-use IDE, hundreds of ready-to-use functions and many integrated tools makes MikroElektronika compilers one of the best choices on the market today. Besides mikroCD, mikroElektronika compilers offer a statistical module, simulator, bitmap generator for graphic displays, 7-segment display conversion tool, ASCII table, HTML code export, communication tools for SD/MMC, UDP (Ethernet) and USB, EEPROM editor, programming mode management, etc.
 Each compiler has many routines and examples such as EEPROM, FLASH and MMC, reading/writing SD and CF cards, writing character and graphics on LCDs, manipulation of push-buttons, 4x4 keyboard and PS/2 keyboard input, generation of signals and sounds, character string manipulation, mathematical calculations, I2C, SPI, RS232, CAN, USB, RS485 and OneWire communications, Manchester coding management, logical and numerical conversion, PWM signals, interrupts, etc. The CD-ROM contains many already-written and tested programs to use with our development boards.

mikroElektronika manufactures competitive development systems. We deliver our products across the globe and our satisfied customers are the best guarantee of our first-rate service. The company is an official consultant on the PIC microcontrollers and the third party partner of Microchip company. We are also an official consultant and third party partner of Cypress Semiconductors since 2002 and official consultant of Philips Electronics company as well. All our products are RoHS compliant.

<http://www.mikroe.com/en/distributors/>

Find your distributor: UK, USA, Germany, Japan, France, Greece, Turkey, Italy, Slovenia, Croatia, Macedonia, Pakistan, Malaysia, Austria, Taiwan, Lebanon, Syria, Egypt, Portugal, India.

Uni-DS 3 Development Board

Complete Hardware and Software solution with on-board USB 2.0 programmer



The system supports PIC, AVR, 8051, ARM and PSoC microcontrollers with a large number of peripherals. In order to continue working with different chip in the same development environment, you just need to switch a card. **UNI-DS3** has many features that make your development easy. You can choose between USB or External Power supply. Each MCU card has its own USB 2.0 programmer!

EasydsPIC4 Development Board

Complete Hardware and Software solution with on-board USB 2.0 programmer and mikroCD



The system supports 18, 28 and 40 pin microcontrollers (it comes with dsPIC30F4013 general purpose microcontroller with internal 12-bit ADC). **EasydsPIC4** has many features that make your development easy. Many of these already made examples in **C, BASIC and PASCAL** language guarantee successful use of the system. Ultra fast **USB 2.0 on-board programmer and mikroCD (In-Circuit Debugger)** enables very efficient debugging and faster prototype developing.

EasyARM Development Board

Complete Hardware and Software solution with on-board USB 2.0 programmer

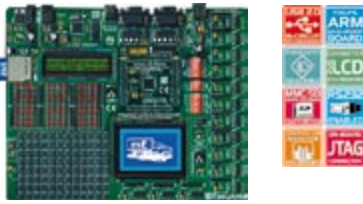

EasyARM board comes with Philips LPC2214 microcontroller. Each jumper, element and pin is clearly marked on the board. It is possible to test most of industrial needs on the system: temperature controllers, counters, timers etc. **EasyARM** has many features making your development easy. One of them is on-board USB 2.0 programmer with automatic switch between 'run' and 'programming' mode. Examples in **C** language are provided with the board.

EasyAVR4 Development Board

with on-board USB 2.0 programmer

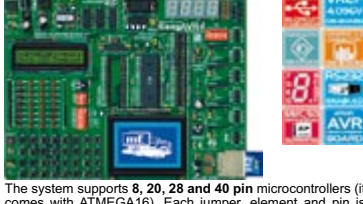

The system supports 8, 20, 28 and 40 pin microcontrollers (it comes with ATMEGA16). Each jumper, element and pin is clearly marked on the board. It is possible to test most of industrial needs on the system: temperature controllers, counters, timers etc. **EasyAVR4** is an easy-to-use Atmel AVR development system. Ultra fast **USB 2.0 on-board programmer** enables very efficient and faster prototype developing. Examples in **BASIC and Pascal** language are provided with the board.

Easy8051B Development Board

with on-board USB 2.0 programmer

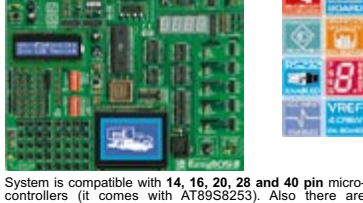

System is compatible with 14, 16, 20, 28 and 40 pin microcontrollers (it comes with AT89S8253). Also there are **PLCC44 and PLCC32** sockets for 32 and 44 pin microcontrollers. **USB 2.0 Programmer** is supplied from the system and the programming can be done without taking the microcontroller out.

LV 18FJ Development Board

Complete Hardware and Software solution with on-board USB 2.0 programmer and mikroCD

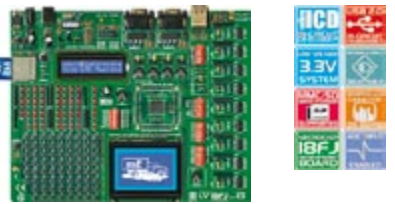

System supports 64, 80 and 100 pin **PIC18FxxJxx** microcontrollers (it comes with PIC18F87J60 - PIC18 Microcontroller with an integrated 10Mbps Ethernet communications peripheral, 80 Pin Package). **LV 18FJ** is easy to use Microchip PIC18FxxJxx development system. **USB 2.0 on-board programmer with mikroCD (In-Circuit Debugger)** enables very efficient debugging and faster prototype development. Examples in **C, BASIC and Pascal** language are provided with the board.

dsPICPRO 3 Development Board

Complete Hardware and Software solution with on-board USB 2.0 programmer and mikroCD



The system supports dsPIC microcontrollers in 64 and 80 pins packages. It is delivered with dsPIC30F6014A microcontroller. **dsPICPRO3** development system is a full-featured development board for the Microchip dsPIC MCU. **dsPICPRO3** board allows microcontroller to be interfaced with external circuits and a broad range of peripheral devices. This development board has an on-board USB 2.0 programmer and integrated connectors for MMC/SD memory cards, 2 x RS232 port, RS485, CAN, on-board ENC28J60 Ethernet Controller, DAC etc...

BIGPIC4 Development Board

Complete Hardware and Software solution with on-board USB 2.0 programmer and mikroCD

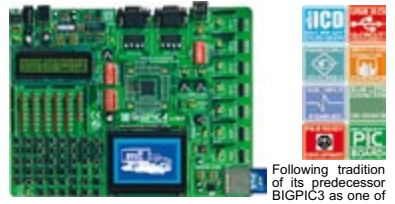

Following tradition of its predecessor **BIGPIC3** as one of the best 80-pin PIC development systems on the market, **BIGPIC4** continues the tradition with more new features for the same price. System supports the latest (64) and 80-pin PIC microcontrollers (it is delivered with PIC18F8520). Many of these already made examples in **C, BASIC and Pascal** language guarantee successful use of the system. Ultra fast on-board programmer and **mikroCD (In-Circuit Debugger)** enables very efficient debugging and faster prototype developing.

BIGAVR Development Board

with on-board USB 2.0 programmer

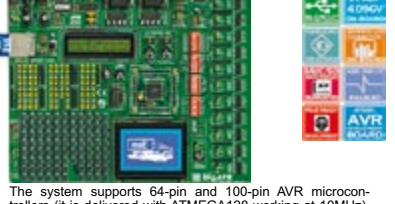

The system supports 64-pin and 100-pin AVR microcontrollers (it is delivered with ATMEGA128 working at 10MHz). Many already made examples guarantee successful use of the system. **BIGAVR** is easy to use Atmel AVR development system. **BIGAVR** has many features that makes your development easy. You can choose between USB or External Power supply. **BIGAVR** also supports Character LCD as well as Graphic LCD.

EasyPSoC3 Development Board

with on-board USB 2.0 programmer

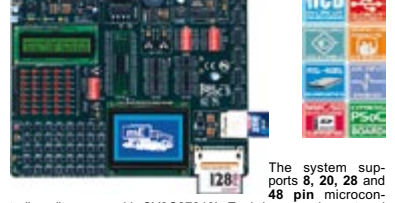

The system supports 8, 20, 28 and 48 pin microcontrollers (it comes with CY8C27843). Each jumper, element and pin is clearly marked on the board. **EasyPSoC3** is an easy-to-use PSoC development system. On-board **USB 2.0 programmer** provides fast and easy in-system programming.

Please visit our website for more info <http://www.mikroe.com>

USB Flash Board

An 8051-based system for rapid software

Alexander Kniel

Flash microcontrollers are easy to program, which makes them suitable for rapid software development environments and educational uses. In the past, program code was usually downloaded via a serial interface, but nowadays many PCs (especially laptops) only have USB ports. Our versatile Flash Board provides a solution to this problem. It is built around an AT89C5131A, which is an extended 8051-family microcontroller with an 80C52 core and a Full Speed USB port. As a sort of bonus, the IC has a complete update interface for downloading new firmware. Atmel also provides suitable software in the form of its FLIP program, which is available free of charge.

The Flash Microcontroller Board originally published in December 2001 is well known to Elektor readers, and it has helped many readers get started in the world of microcontrollers. That's hardly surprising, since microcontrollers with flash memory, such as the AT89C8252 used in the original Flash Board, are easy to program. As with many other similar boards used for educational purposes, the code is downloaded from a development PC to the microcontroller via a serial interface. Unfortunately, the good old RS232 interface is becoming increasingly rare. Laptops in particular often have only USB ports and no longer come with printer ports or serial ports. If a teacher wants to give his students training boards that they can also program at home using a laptop, a different approach is necessary.

The author, an electronics instructor at a vocational/technical school in Heilbronn (Germany), thus developed a version of the Flash Board based on a modern microcontroller with a USB interface. For this purpose he selected the Atmel AT89C5131AM, which has an 80C52 core and thus belongs to the 8051 family, just like the AT89C8252. The IC incorporates an Full Speed USB

port, and it is specifically designed for use in USB devices such as printers, cameras, and so on. As a sort of bonus, the microcontroller has a complete update interface for downloading new firmware. This in particular enabled the author, who has a weakness for hardware and all sorts of programming languages, to build an extremely simple USB Flash Board because Atmel also provides suitable software in the form of its FLIP program, which is available free of charge. All you have to do is provide the program code in a hex file and you're ready to go.

Generation-2 Flash Board

Many copies of the first version of the new board developed by Alexander Kniel have already been built by students and used with laptop computers. The board design was modified slightly in the Elektor lab, and among other things Elektor designer Chris Vossen added an LCD interface. The board thus follows in the footsteps of the 2001 version of the Elektor Flash Microcontroller Board and is suitable for not only learning how to program microcontrollers, but also for mature applications in device controllers, robots, and many other areas. Everything revolves around the abo-

ve-mentioned AT89C5131AM, which is an extended member of the 8051 family. Its core is an 80C52X2 with six clocks per instruction cycle. Besides 32 KB of flash memory, the IC has 1024 bytes of extended RAM, additional EEPROM, and many other useful peripherals. Another helpful feature is that the M version of the microcontroller can also operate at 5 V, and a version in the user-friendly PLCC52 package is available. However, probably the most important feature is the USB 1.1 / USB 2.0 Full Speed module (for the experts: with endpoint 0 for control transfers and six additional endpoints with up to 512 bytes of FIFO memory). If you want to develop USB software, this gives you everything you could wish for, although you do need a bit of technical expertise. Everyone else can regard the microcontroller as a normal 8051 device that can be programmed via USB.

The schematic diagram (Figure 1) shows a dual power supply that can draw power either from the USB bus or (with jumper JP4 fitted) via voltage regulator IC2 from an AC adapter connector K9. The D+ and D- pins of the

Figure 1. Schematic diagram of the USB Flash Board.

development

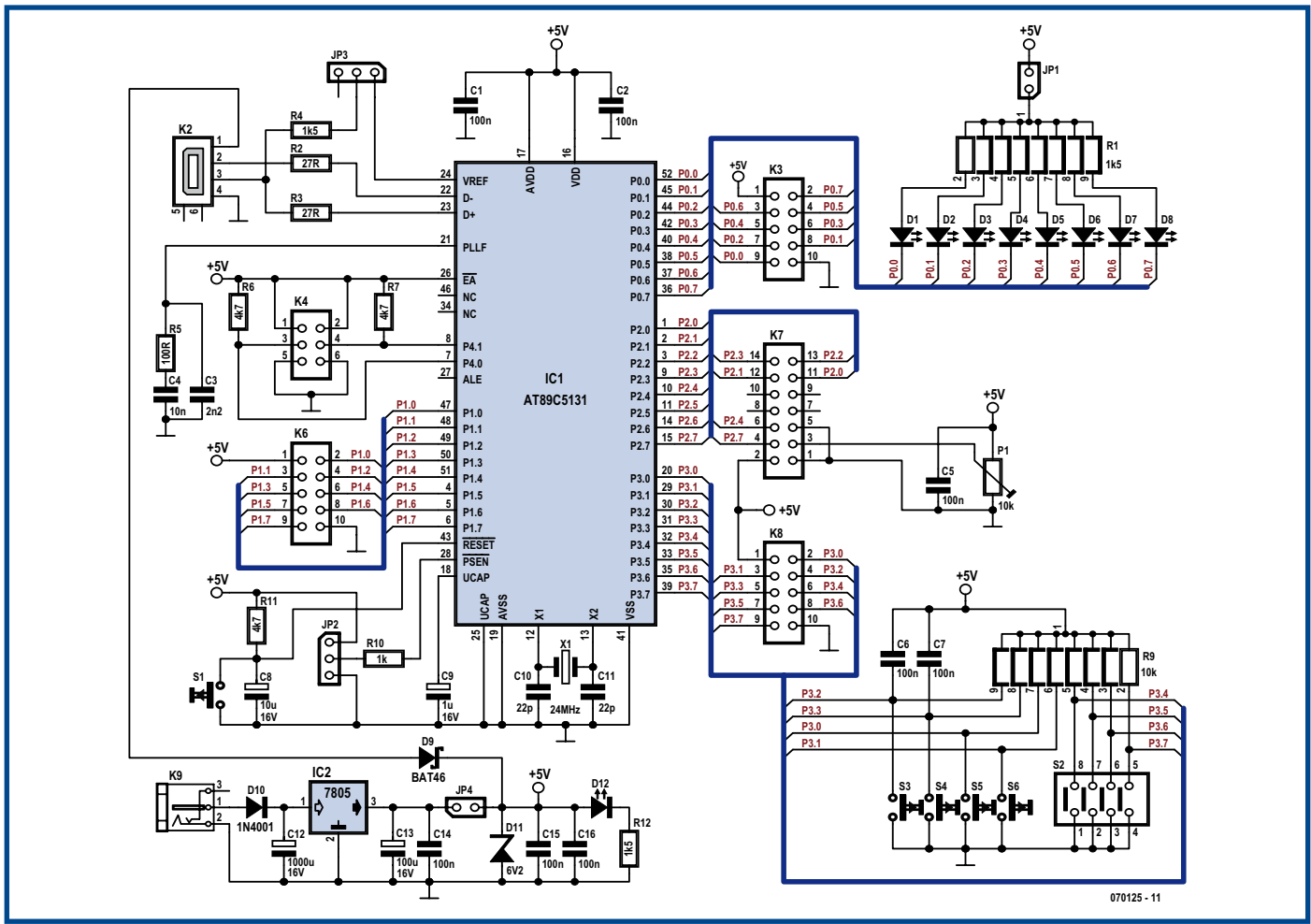
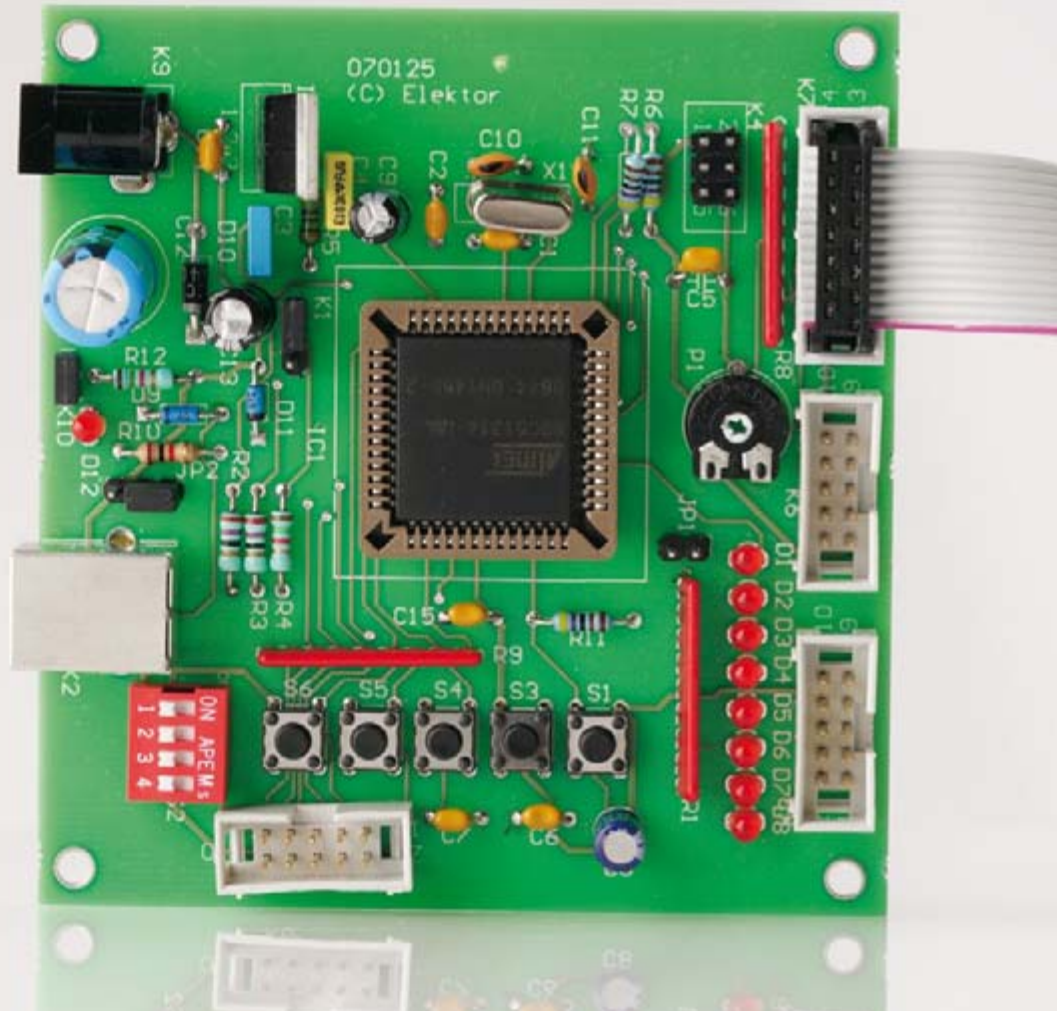

070125 - 11

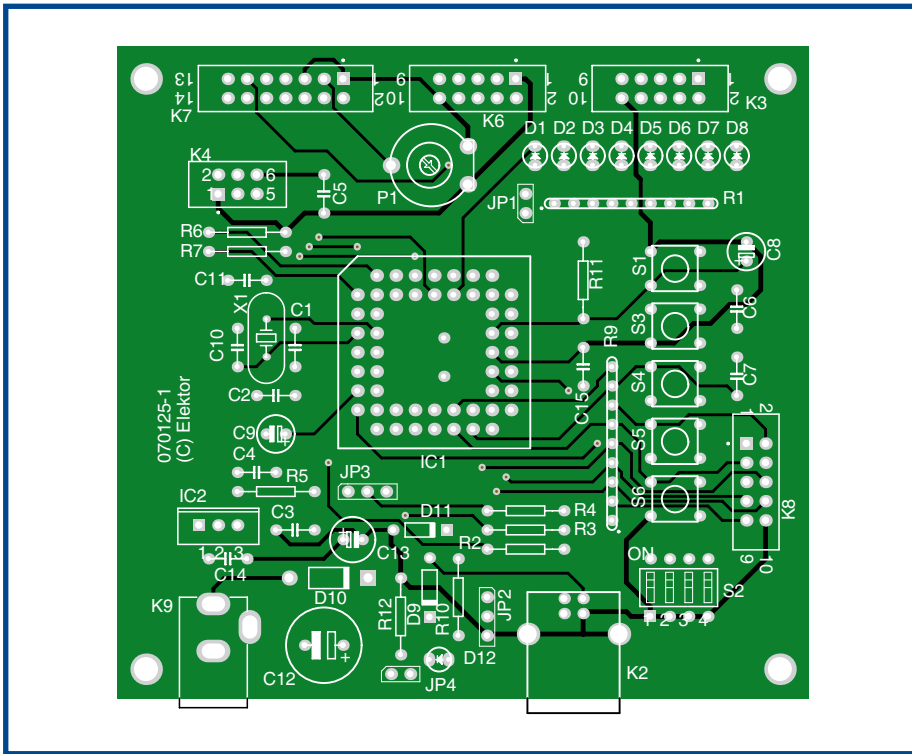

Figure 2. Assembling the circuit board should not present any problems.

microcontroller are for the USB data lines. To activate the internal USB boot loader, a low signal level must be applied to PSEN via JP2 (jumper toward the edge of the board).

When reset switch S1 is pressed, the boot loader starts up and receives data via the USB port. Jumper posi-

tion JP3 must be closed (jumper toward IC2) to activate the USB port. This connects pullup resistor R4 to the D+ line, which indicates a Full Speed USB device to the PC. If you would like to have a more convenient way to switch between run mode and download mode, you can connect a changeover switch to JP2 and JP3.

It can be fitted directly on the PCB or mounted on a front panel.

Four full-fledged 8-bit ports

The microcontroller has four full-fledged 8-bit ports, each of which is accessible via a connector and/or assigned a specific peripheral function. Port P0 is available on K3, and it also drives eight LEDs that can be connected to VDD (+5 V) via series resistors. Port P1 is freely usable and accessible via K6. Port P2 is wired to LCD connector K7. An LCD module can be operated in 4-bit mode via this connector, and a contrast adjustment trimpot is provided on the board. Finally, port P3 is specifically intended to be used for inputs, and it can be accessed externally via K8. For testing user-developed programs, the board is fitted with pullup resistors, four pushbutton switches (P3.0...P3.3), and four DIP switches (P3.4...P3.7) on port 3. Switches normally require debouncing, which can usually be implemented in software. The P3.2 and P3.3 lines have supplementary hardware debouncing in the form of capacitors C6 and C7, since these lines are connected to the interrupt inputs of the microcontroller. We also mustn't forget port P4 with the P4.0 and P4.1 lines, which form the I2C bus interface and are accessible via K4.

The bare PCB for the USB Flash Board (Figure 2) is available from the Elektor Shop under order number 070125-1. Alternatively, you can purchase a complete kit with all the components under order number 070125-71. Assembling the board is not difficult. Be sure to avoid creating any shorts between D+, D- or the 5 V supply line and ground in the area around the USB socket. As there is no special protection for the D+, D- and 5-V supply lines, it's a good idea to check this with an ohmmeter – but be sure to remove the microcontroller from its socket first. There is room for an extra 100-nF ceramic capacitor beneath the IC socket, which should be fitted first. It provides optimal supply voltage decoupling.

Initial operation

You should use an AC adapter (8–12 V DC) for initial testing. Fit jumper JP4 to select this power source. LED D1 should light up now. If you have already connected an LCD module, it

Components list

Resistors

- R1 = 1kΩ5 8-way SIL array
- R2,R3 = 27Ω
- R4,R12 = 1kΩ5
- R5 = 100Ω
- R6,R7,R11 = 4kΩ7
- R9 = 8-way 10kΩ array
- R10 = 1kΩ
- P1 = 10kΩ potentiometer

Capacitors

- C10,C11=22pF
- C3 = 2nF2
- C4 = 10nF
- C1,C2,C5,C6,C7,C14,C15,C16 = 100nF
- C8 = 10μF 16V
- C9 = 1μF 16V
- C12 = 1000μF 16V
- C13 = 100μF 25V

Semiconductors

- D1-D8,D12 = LED, red, low-current
- D9 = BAT46
- D10 = 1N4001
- D11 = zener diode 6V2
- IC1 = AT89C5131AM
- IC2 = 7805
- X1 = 12MHz quartz crystal

Miscellaneous

- JP1,JP4 = 2-way SIL pinheader
- JP2,JP3 = 3-way SIL pinheader
- K2 = USB-A socket
- K3,K6,K8 = 10-way boxheader
- K4 = 6-way (2x3) pinheader
- K7 = 14-way boxheader
- K9 = mains appliance socket, PCB mount
- S1,S3-S6 = miniature pushbutton
- PLCC socket
- PCB, # 070125-1 from Elektor SHOP
- Kit of parts, # 070125-71 from Elektor SHOP

should display dark pixels in the top line. If necessary, adjust the contrast trimpot until both lines are clearly distinguishable. The upper line will remain dark until the board has been initialised with a program. If you have an oscilloscope, you can also check the 12-MHz clock signal on the crystal. This clearly shows that the microcontroller is running.

You have to download a program for the first real software test. For this purpose, you can use the Flexible In-System Programmer (FLIP) software, which you can download free of charge from Atmel's home page (www.atmel.com). Enter 'Flip' as the search term to find FLIP 2.4.6 for Windows (4 MB, Version 2.4.6, updated May 2006). First extract the contents of archive file flip-2_4_6.zip to a separate folder and then run the Setup.exe file in that folder. Follow the installation instructions and accept the licence conditions and suggested installation location. You will then see a short list of instructions for what you have to do next (Figure 3). The program is installed by default in C:\Program Files\Atmel\FLIP 2.4.6\.

Now connect a cable to the USB connector and fit jumper JP2 in the 'USB' position (toward the edge of the board). To be on the safe side, press reset switch S1 and close JP3. This starts the USB download firmware, which waits for contact with the PC to be established. The program reports vendor ID 03EB and product ID 2FFD, which enable Windows to assign a suitable driver. Windows will recognise a new device and ask you to select a suitable driver. Select the driver located in folder C:\Program Files\Atmel\FLIP 2.4.6\usb (see Figure 4). After it is installed, you will see the new device in the Device Manager window. It can be recognised by its name 'Jungo AT89C5130/AT89C5131'.

If something goes wrong during this process, you have to track down the problem. Possible problem sources include incorrectly fitted jumpers. For instance, if you activate the USB port with JP3 (pullup connected to D+) but do not start the internal firmware (JP2 still in the 'Run' position or no reset executed after switching over), Windows will report a new device – but not the right one. By contrast, you might start the update firmware correctly but fit JP3 incorrectly. In this case, Windows will not recognise that a device

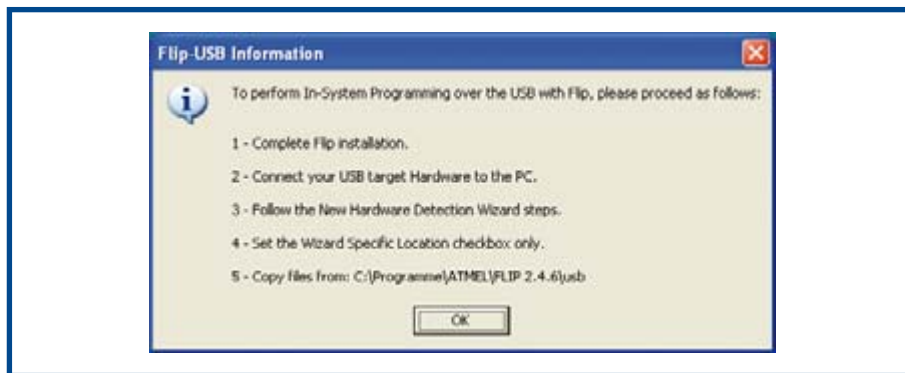

Figure 3. The free FLIP programming software displays a list of what you have to do to start using the board.

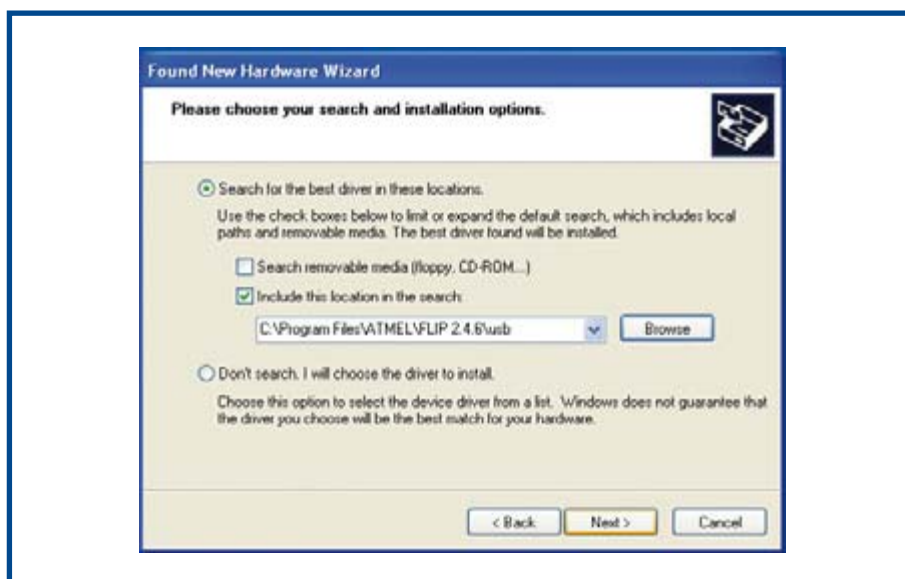

Figure 4. The microcontroller is recognised by Windows as a new device.

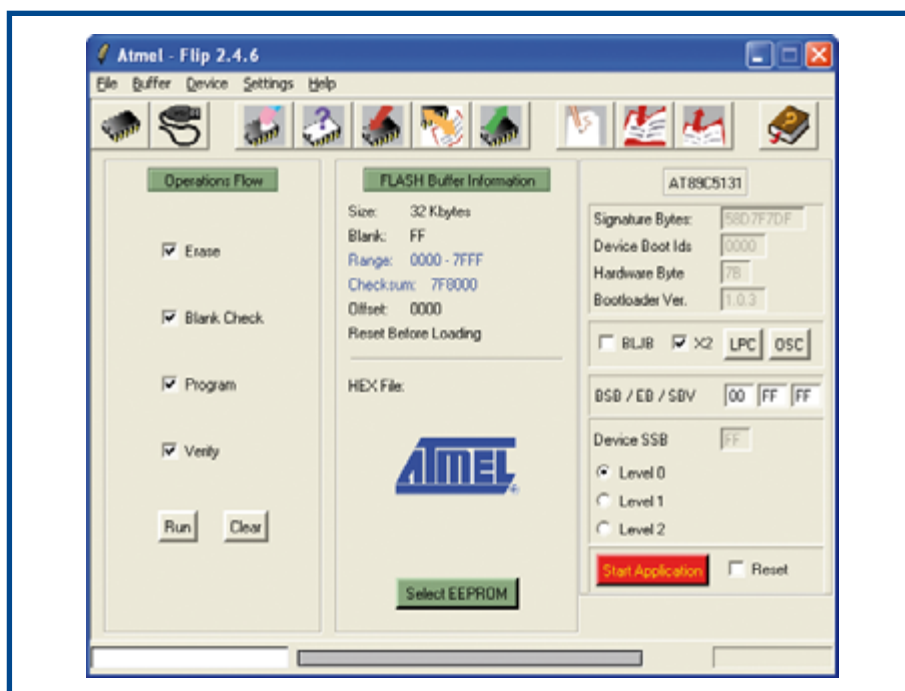

Figure 5. After you click Run, FLIP downloads the program to the flash memory of the microcontroller.

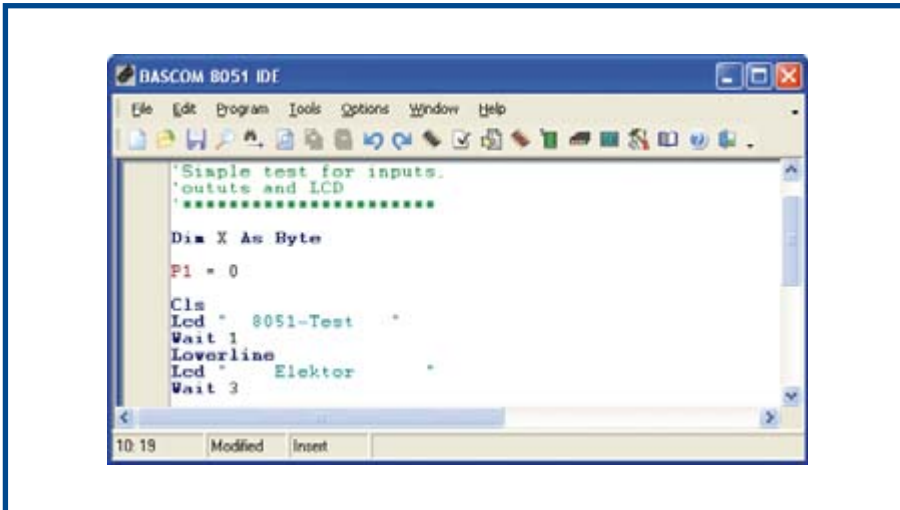

Figure 6. Main menu of the BASCOM compiler.

is connected, and thus no communication will be established. After a bit of practice, you won't have any problems making the right settings, and you can establish a communication session with the PC whenever you need it.

Program download

Now launch FLIP. First you have to use F2, Device à Select, or the IC icon to select the correct IC (AT89C5131). Then use F3, Settings à Communication à USB, or the cable icon to select and open the USB interface. Finally, you have to use F4 or File à Load Hex

File to load a suitable hex file. Select program file: 5131_TEST_ELEKTOR.HEX, which you can obtain along with the BASCOM AVR source code from the Elektor home page. Click the Run button (see Figure 5) to download the program code to the flash memory. After this, you must change over JP2 and press the Reset button to run the program. Caution: the BLJB option is enabled automatically with a new microcontroller. You must deselect (uncheck) it the first time you download a program, since otherwise it will not be possible to run the program after it has been downloaded.

If you want to download a new hex file after this test, you must first disconnect the USB cable and then reconnect it – and of course, with the right jumper settings and a Reset first. After this, you must establish the connection again in FLIP.

Alternatively, you can leave the USB cable connected and simply open JP3, which will also isolate the device from the USB without interrupting the supply voltage. In order to download a new program, you must first change the setting of JP2 again. The press Reset, wait two seconds, and fit JP3 again. This initialises the USB device. You will have to open the interface in FLIP again, after which you can start the download.

Programming with BASCOM

The BASCOM-51 Basic compiler is an ideal tool when you are just getting started with developing programs for the system, although you can also write programs for the microcontroller in C or assembly language. You can download a free demo version of BASCOM-51 from the site of its producer, MCS Electronics (www.mcselec.com). The free version can generate up to 4 KB of code, which is sufficient for many applications.

Figure 6 shows the main menu of the compiler. In order to ensure correct operation of the board, you must as-

```

Hardware test in Bascom-51
'Simple test for inputs,
'outputs and LCD
'*****

Dim X As Byte
P1 = 0

Cls
Lcd " 8051-Test "
Wait 1
Lowerline
Lcd " Elektor "
Wait 3

For X = 1 To 13
Shiftlcd Right
Waitms 200
Next

Cls
Lcd " Test Port 0 "
Lowerline
Lcd " Bit 2 exp 0 "

P0 = &B11111110
Wait 1
Lowerline
Lcd " Bit 2 exp 1 "
P0 = &B11111101
Wait 1
Lowerline
Lcd " Bit 2 exp 2 "
P0 = &B11111011
Wait 1
Lowerline
Lcd " Bit 2 exp 3 "
P0 = &B11110111
Wait 1
Lowerline
Lcd " Bit 2 exp 4 "
P0 = &B11101111
Wait 1
Lowerline
Lcd " Bit 2 exp 5 "
P0 = &B11011111
Wait 1
Lowerline
Lcd " Bit 2 exp 6 "
P0 = &B10111111
Wait 1
Lowerline

Lcd " Bit 2 exp 7 "
P0 = &B01111111
Wait 1
Lowerline
Lcd " All Bits "
P0 = &B00000000
Wait 1

Cls
Lcd " Test Port 3 "
Lowerline
Lcd " Test Port 0 (LED) "
Wait 3

Status:
P0 = P3
X = P0
Cls
Lcd " Inputs "
Lowerline
Lcd "Port 3 = " ; X ; "
Waitms 60
Goto Status

End
    
```

sign the LCD pins to port P2 under Options (Figure 7).

BASCOM supports configuration of different register files for individual 8051 derivatives. Although there are no specific settings for the AT89C5131, this microcontroller is largely compatible with the 8052, so you should use register file 8052.dat.

The listing shows the source code of the test program. It is easy to read and largely self-explanatory. After an introductory message is displayed on the LCD, a running-light routine is executed to check all the LEDs on Port P0. Following this, the inputs on port P3 are read in an endless loop and their states are copied to output port P0

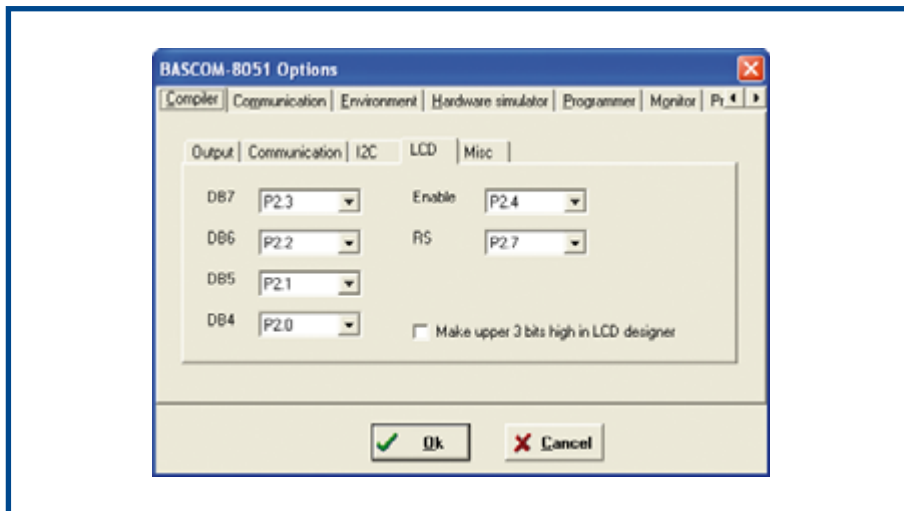
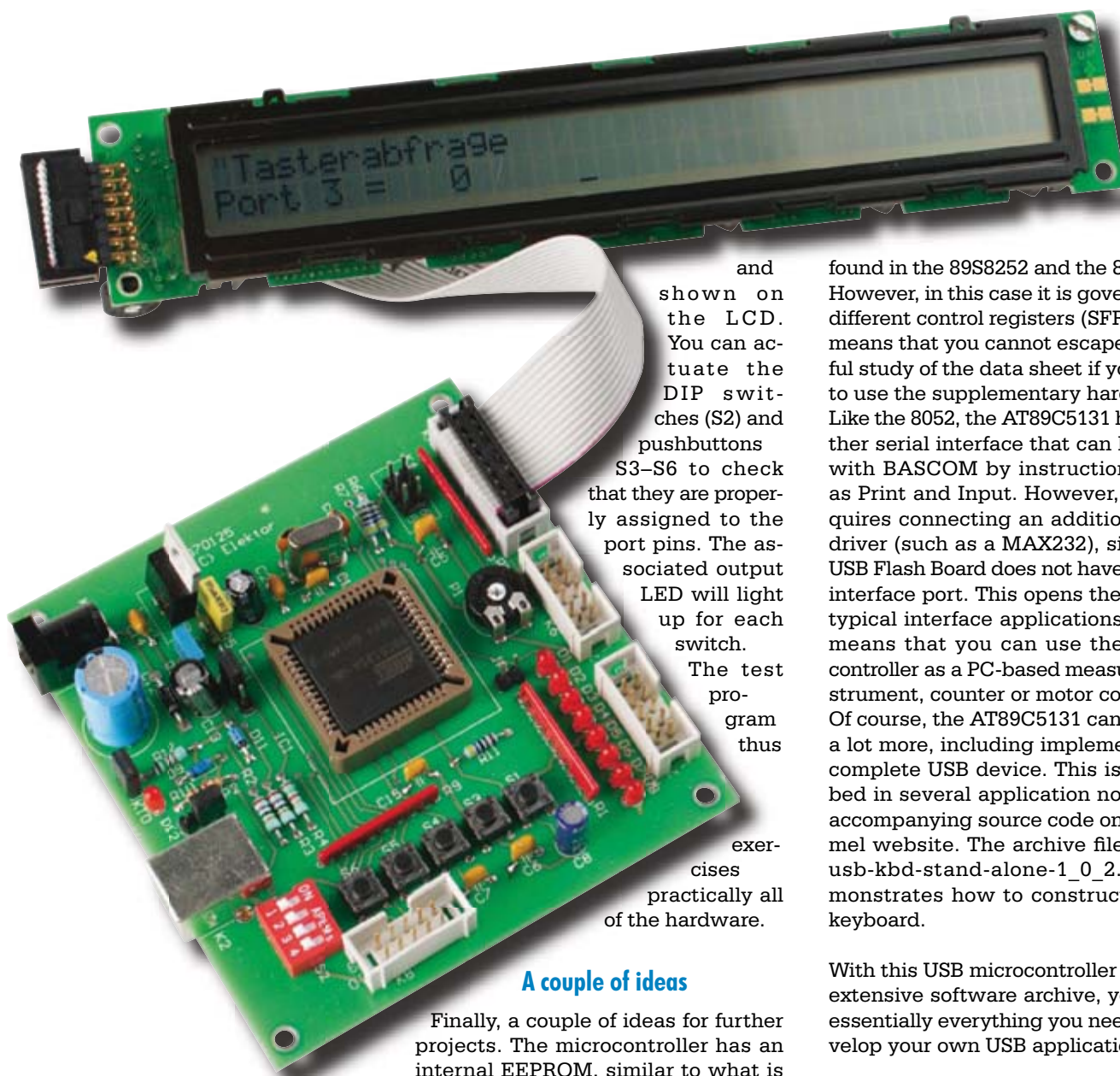

Figure 7. The assignment of the LCD pins to port P2 must be configured under Options.



and shown on the LCD. You can actuate the DIP switches (S2) and pushbuttons S3-S6 to check that they are properly assigned to the port pins. The associated output LED will light up for each switch. The test program thus exercises practically all of the hardware.

A couple of ideas

Finally, a couple of ideas for further projects. The microcontroller has an internal EEPROM, similar to what is

found in the 89S8252 and the 89S8253. However, in this case it is governed by different control registers (SFRs). This means that you cannot escape a careful study of the data sheet if you want to use the supplementary hardware. Like the 8052, the AT89C5131 has another serial interface that can be used with BASCOM by instructions such as Print and Input. However, this requires connecting an additional line driver (such as a MAX232), since the USB Flash Board does not have a serial interface port. This opens the door to typical interface applications, which means that you can use the microcontroller as a PC-based measuring instrument, counter or motor controller. Of course, the AT89C5131 can also do a lot more, including implementing a complete USB device. This is described in several application notes and accompanying source code on the Atmel website. The archive file c5131-usb-kbd-stand-alone-1_0_2.zip demonstrates how to construct a USB keyboard.

With this USB microcontroller and the extensive software archive, you have essentially everything you need to develop your own USB applications.

(070999-1)

Line Switcher

A single phone for two lines

Nicolas Boullis

More and more ISPs are offering subscribers an extra phone line using Voice over IP (VoIP) on top of their Internet access.

As a result, the number of people with two phone lines in their home is constantly increasing. These are easy enough to manage by connecting one (or more) phones to each line. But then you have to decide which phone to pick up when it rings (well, that's easy – it's the one that's ringing!) or when you want to make a call (trickier, that one!).

The project described here reduces this inconvenience by letting you connect a single phone to two lines at once, to avoid having to tie knots in the cables! It's a phone line switcher that routes the 'correct' line to the phone automatically.

Specification

Lots of phone devices (answering machines, cordless phones) need external power to work. To avoid adding yet another power supply, we decided to make this project run on batteries (or better still, NiMH rechargeables). This does have an extra advantage: the switcher stays working even in the event of a power cut, so you can still call the electricity company. The downside is that we had to watch the power consumption, to get maximum battery life.

Line selection needs to follow a certain logic:

- If one line is already in use via the switcher, under no circumstances must that line be switched, as that would cause the loss of the communication in progress.
- The user must have the option of manually selecting the line of their choice – for example, to be able to make a call on one line while the other is ringing, or to use a particular line to call a number at a special rate, or which is not accessible from certain types of line.
- If there is no manual selection or communication in progress, a line must be selected if it rings.
- Otherwise, Line 1 (the ISP VoIP line) is selected by default, so long as it is 'available' – a line of this type will be unavailable during power cuts or if the 'super-modem' is turned off for some reason.

- Lastly, in the absence of Line 1, Line 2 must be selected.

As we don't necessarily know how the two lines are referenced with respect to earth, it's important that both lines should be well isolated electrically. By the same token, to eliminate any danger, both lines must also be isolated from the logic part of the circuit.

And lastly, there must be some way of indicating to the user at all times which line they are using, and which line(s) is/are ringing.

One other aspect we mustn't forget: to be accessible to as many people as possible, the project should use only readily-obtained components that are easy to solder (and don't require any programming!)

Phone lines

Building this switcher requires you

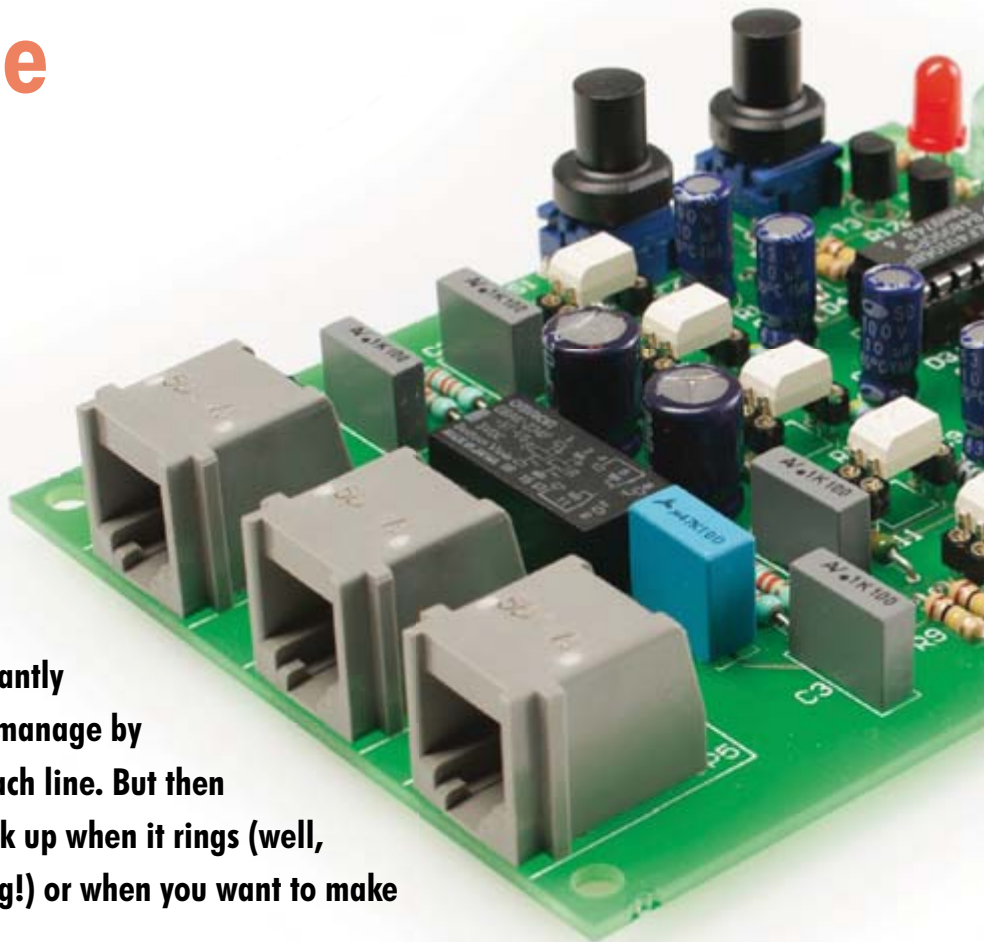

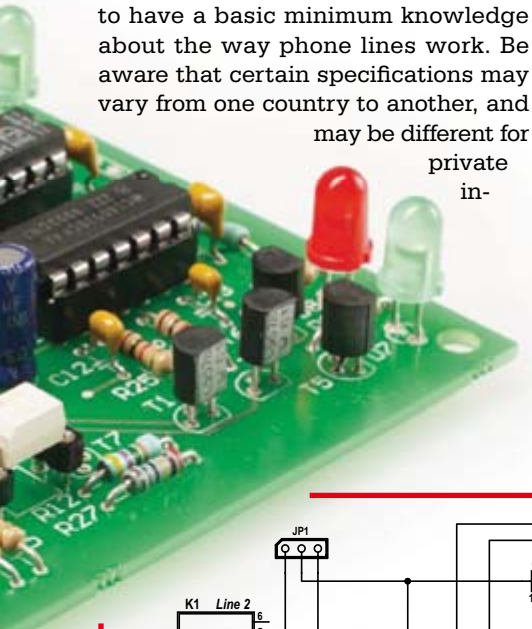

to have a basic minimum knowledge about the way phone lines work. Be aware that certain specifications may vary from one country to another, and may be different for private in-

stallations – as may be the case for the phone lines provided by ISPs too. Quiescent, a phone line appears as a DC voltage source of 48 V, the polarity of which is not necessarily defined, and on certain installations may even vary over time. During ringing, an AC voltage is superimposed on this DC voltage. The swing and frequency of the ring voltage differs from country to country. In the author’s home country, France, this is a sine wave of around 50 V_{rms} and with a frequency of 50 Hz. The ring signal

lasts around 2 seconds, with intervals of around 3 seconds. When a phone takes the line, it must draw a DC current of 20–50 mA. This current causes a substantial drop in the DC line voltage, which may fall to around 10 V or so.

Control unit

To switch the phone lines efficiently, while maintaining the isolation between the two lines, the natural choice is a 2-pole changeover relay. However,

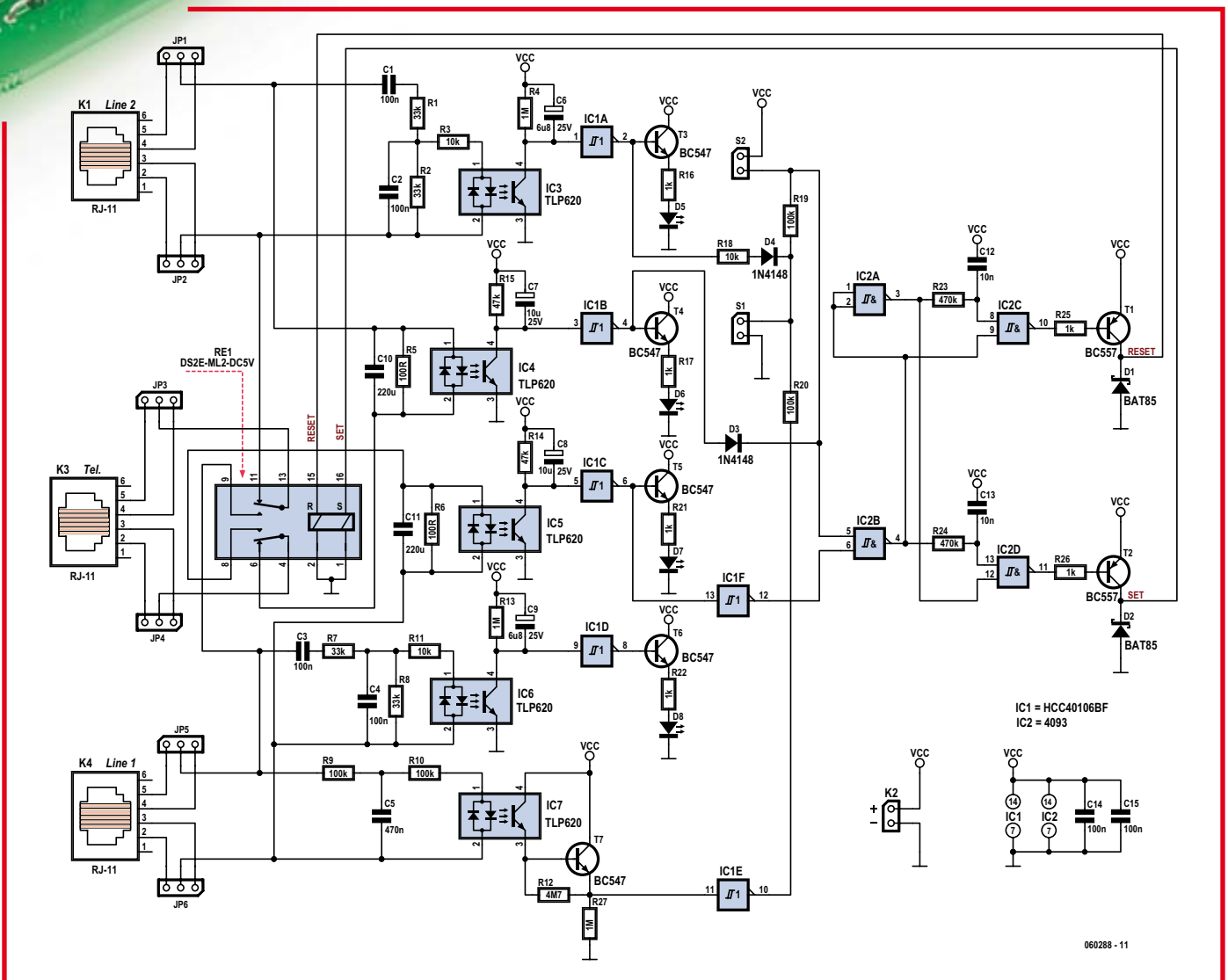

Figure 1. Circuit diagram of the line switcher.

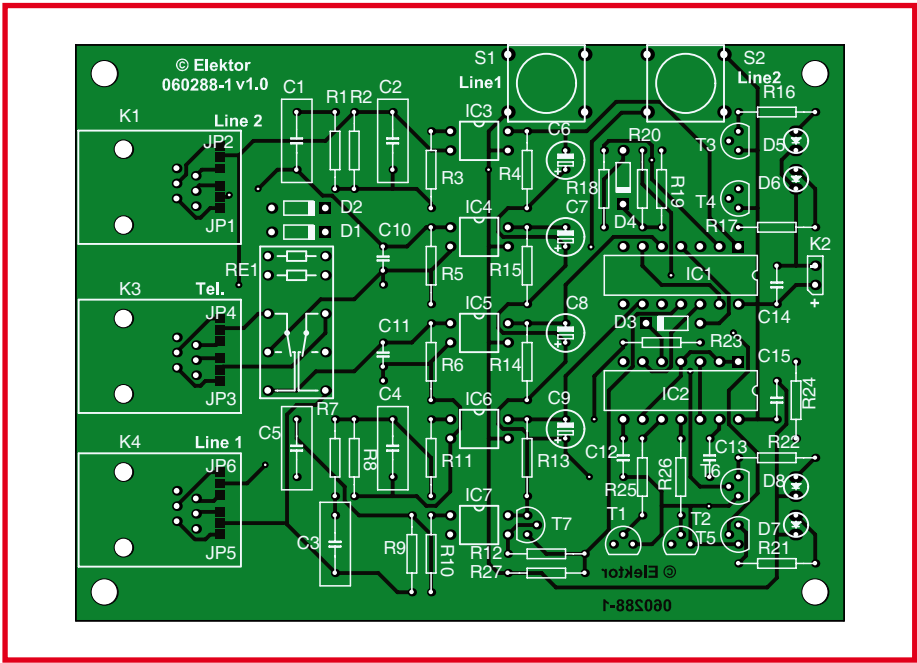

Figure 2. Pattern of the generously-sized double-sided through-hole plated switcher board.

COMPONENTS LIST

Resistors

R1,R2,R7,R8 = 33kΩ
 R3,R11,R18 = 10kΩ
 R4,R13,R27 = 1MΩ
 R5,R6 = 100Ω
 R9,R10 = 100kΩ
 R12 = 4MΩ
 R14,15 = 47kΩ
 R16,R17,R21,R22,R25,R26 = 1kΩ
 R19,R20 = 100kΩ
 R23,R24 = 470kΩ

Capacitors

C1-C4 = 100nF (7.5mm pitch MKT)
 C5 = 470 nF (7.5mm pitch MKT)
 C6,C9 = 6μF 8 100 V
 C7,C8 = 10μF 100 V
 C10,C11 = 220μF 10V non-polarised
 C12,C13 = 10nF (5mm pitch Sibatit/ceramic)

C14,C15 = 100nF (5mm pitch Sibatit/ceramic)

Semiconductors

D1,D2 = BAT85
 D3,D4 = 1N4148
 D6,D7 = LED, 3mm, green (low power)*
 D5,D8 = LED, 3mm, red (low power)*
 T1,T2 = BC557
 T3-T7 = BC547
 IC1 = 40106BF
 IC2 = 4093
 IC3-IC7 = TLP620 (Toshiba optocoupler)

Miscellaneous

K1,K3,K4 = RJ11 6/4 phone socket (Hirose TM5RE1-64)
 K2 = 2-way SIL pinheader for power: 9 V NiMH battery
 S1,S2 = pushbuttons
 RE1 = Bistable 5 V 2-pole c/o relay (Panasonic DS2E-ML2-DC5V or Omron G6AK-234P-ST-US)
 * see text

the use of a conventional relay is hard to reconcile with very low power consumption, in view of the fact that it might be in either position for a long time. So we opted for a bistable relay. These exist in single- and dual-coil versions. A single-coil one is driven using an H-bridge, which requires four transistors and four diodes. However, the dual-coil version needs only two transistors and two diodes, and the transistor drive is simpler. Whence our choice of a dual-coil bistable 2-pole changeover relay.

To ensure proper switching even with a slightly low battery, the relay chosen is designed for 5 V working.

Circuit

Let's take a look at the way the switcher works, with the help of the circuit in **Figure 1**, and examine the various functions.

Detection

There are three things to detect for the phone lines: presence (for Line 1 only), ringing, and line use through

the switcher. Each of these requires its own detection system. To detect if Line 1 (connected via RJ-11 socket K4) is in use, the 20–50 mA current drawn by the phone passes through one or other of the two inverse-parallel connected LEDs in optocoupler IC5. This results in saturation of the phototransistor, taking the Schmitt inverter IC1C input to '0', giving a logic '1' at the inverter output. Resistor R6 sinks 10 mA before the optocoupler LEDs light, to avoid their reacting to currents that are too low. By the same token, unpolarized capacitor C11 shunts away the AC current present during ringing. The time constant formed by R14 and C8 avoids the circuit's reacting to very short line-interrupts (up to around 0.5 s). Such interrupts are used for loop-disconnect dialling (increasingly rare these days, replaced by DTMF dialling) or when using a phone's 'R' key.

Ring detection involves detecting a high-amplitude AC signal. The circuit formed by C3, C4, R7, and R8 constitutes a rudimentary bandpass filter centred at around 50 Hz. The filter output feeds the two inverse-parallel connected LEDs in IC6, via resistor R11. When the ring signal is present, the phototransistor is regularly saturated, taking inverter IC1D input to '0', giving an output at logic '1'. The time constant formed by C9 and R13 maintains this logic '1' for around 5 seconds after the ring signal ends, to cover the gaps between rings.

And lastly, Line 1 presence is checked by detecting the DC voltage on the line, which may be between 10 V (line busy) and 50 V (line free). During ringing, detection may be upset by the superimposed AC signal, so this is attenuated by the low-pass filter formed by C5 and R9. When the line is present, resistor R10 acts to limit the current in the diodes in IC7 to a value between 40–250 μA – well below the current representing a busy line, so as not to upset the operation of the telephone exchange. Having such a low current in the LEDs means the corresponding optotransistor doesn't saturate fully, so the current is amplified in transistor T7. This does saturate, taking inverter IC1E input to '1', giving a logic '0' at its output. There is a problem with the leakage current of the phototransistor, specified as less than 100 nA. However, even this tiny current, multiplied by the gain of T7, might be enough to take the inverter input to '1'. To avoid this, resistor R12 shunts 120 nA away from

being amplified by T7.

Indication

For each line, a pair of transistors on the output of the line busy and ring detectors lights each of the pairs of LEDs (D5/D6 and D7/D8) either red for ringing and green for line busy.

Line selection logic

Line selection is achieved by resistors R18, R19, and R20, diodes D3 and D4, the pushbuttons wired to connections S1 and S2, inverter IC1F and NAND gate IC2B. Push-button S1 forces selection of Line 1 and S2, Line 2 (connected via RJ-11 socket K1).

As the order of priority between the two manual selections is not defined in the specifications, we went for the simplest option: manual selection of Line 2 takes priority over selection of Line 1. The same goes for the ringing priorities: we have opted to give ringing on Line 2 priority over ringing on Line 1. Given that a line can't ring if it isn't present, Line 1 ring detection has no influence on the selection, and is used for indication only.

The output of gate IC2B is logic high ('1') for Line 1 selection and low ('0') for Line 2.

Relay drive

From this line selection, we need to generate pulses to switch the relays. Gate IC2A is wired as an inverter to invert the selection signal. The normal and inverted selection signals are delayed via C12/R23 and C13/R24. Then

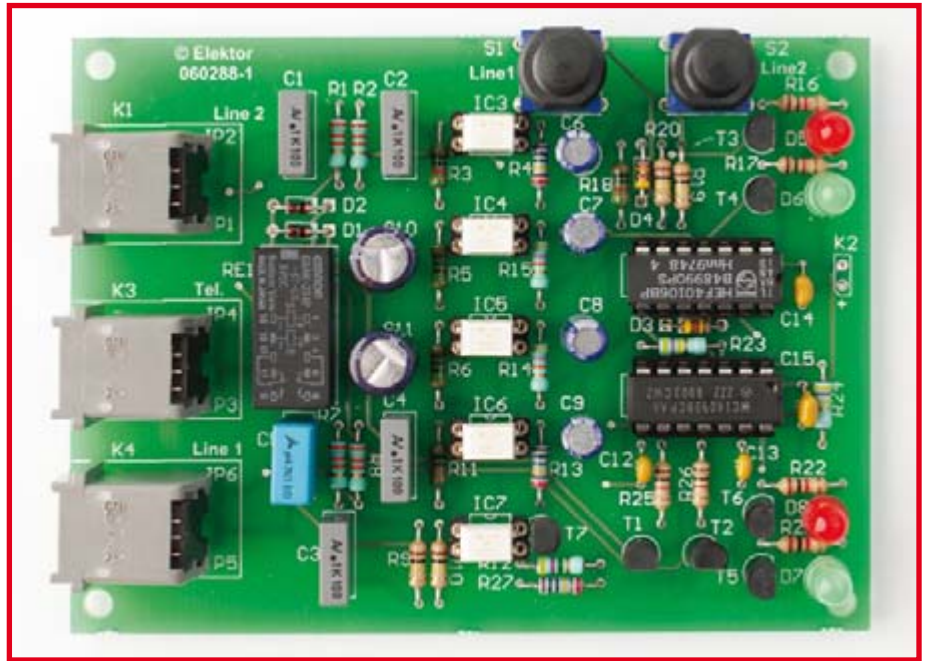

Figure 3. Finished example of line switcher.

NAND gates IC2C and IC2D each combine one delayed signal with the complementary un-delayed signal to generate a 'low' pulse. This pulse is amplified by transistor T1 or T2 to drive the relays. The values selected for C12, C13, R23, and R24 produce pulses of around 5 ms which is enough to toggle the chosen relay.

You'll notice connections JP1–JP6 on the circuit diagram – we'll be talking about them in the next paragraph.

Construction

Having looked at the theoretical side of this project, now it's time to get our hands dirty. Thanks to the double-sided through-hole plated circuit board shown in **Figure 2**, building this project – which doesn't use any exotic components apart from the relays – is within the capabilities of any Elektor reader. Just the time it takes to warm up the soldering iron, fit the components into their designated places (paying attention to the orientation of polarized components – C6–C9, C10, and C11 are non-polarized), solder them one by one and we're (almost) done. We've suggested using RJ-11 sockets to connect the incoming lines (Line 1 and Line 2) and phone (Tel). Fitting the relay is no problem – it's impossible to get it the wrong way.

Take care fitting LEDs D5–D8 – the cathode goes at the bottom (i.e. pointed end) of the symbol on the compo-

nent overlay. Push-buttons S1 and S2 connect to the points marked for them on the board.

Now care is needed with the pin connections to sockets K1, K3, and K4 – this is where connections JP1–JP6 come into play. They are used to adapt the circuit to the characteristics of the phone line concerned. You won't find them marked on the board, as they're only pairs of solder pads to be jumpered. You'll need to use a multimeter to check the active pins at the input to each phone line and short across the appropriate pairs of pads JP1–JP6 with a blob of solder to make the correct connections. We opted for this solution because of the differences in phone socket pin assignments between countries – and even within one country you may encounter 'variable' solutions, as a result of the telecomms markets being opened up. After checking your construction over carefully, all that remains is to connect the power (9 V PP3 dry battery or rechargeable) to the connector provided, K2.

Getting going

When the switcher is turned on, the relays would be in an indeterminate state.

For this reason, it's important to ensure that a pulse is generated to force them into the state 'selected' by IC2B. When power is applied, capacitors C12 and

For private domestic use only

Readers should note that this project is to be used for private, domestic installations only. You should be aware of the fact that connecting home-built equipment to the public switched telephone network (PSTN) is prohibited.

The project described here reduces this inconvenience by letting you connect a single phone to two lines at once, to avoid having to tie knots in the cables! It's a phone line switcher that routes the 'correct' line to the phone automatically.

Bicolour LEDs for D5/D6 and D7/D8

What if we want to replace the pairs of red/green LEDs with 3-pin dual-colour LEDs? Our engineers have already thought of that. All you have to do is to fit a single bicolour LED in the top three holes – making sure you get it the right way round, otherwise it will light green when it's meant to be red and vice-versa. As the chips in dual-colour LEDs have different efficiency for red and green, it will be necessary to change the value of the dropper resistors in the dual-colour LED anode lines. Resistors R17 and R21 for the green need to be changed to 2kΩ2 (instead of the original 1 kΩ).

C13 are discharged. Hence they force both supposedly complementary delayed signals 'high' for around 5 ms. Thus, irrespective of which state is selected by gate IC2B, a pulse will always be generated at power-up, so the relays will be set to a known state.

Power consumption

Quiescent, and with Line 1 present, most of the power is consumed in resistor R27 (1 MΩ), giving a consumption of less than 10 μA – with a 200 mAh battery, that would give a life of over two years.

If Line 1 is absent, the quiescent power consumption is even lower (measured at less than 1 μA).

In operation, most of the power is used to light the LEDs, i.e. around 6 mA for line busy (green LED) or 7 mA during ringing (red LED). So the same battery would allow around 30 hours of communication or 28 hours of ringing.

(060288-1)

Web Links

- www.rennes.supelec.fr/ren/fi/elec/docs/telefon.htm (note: this link gives information about the phone system used in France)
- www.semicon.toshiba.co.jp/docs/datasheet/en/Opto/TLP620_TLP620-4_en_datasheet_020925.pdf

Advertisement

Electronics Engineers - Join A Winning Team! UK and Czech Republic

We are looking for Engineers for the United Kingdom & Czech Republic.

The Lektronix Group of Companies are the worlds leading provider of Industrial Automation repairs with an enviable reputation for the best in technical excellence and customer service.

Due to the huge demand for our services we need to employ additional engineers at our three UK workshops (West Midlands, South Wales and Northern Ireland) to keep pace with the work we are receiving.

Also, due to future expansion throughout Europe we are looking for English speaking engineers to train and work in the UK with eventual relocation to our workshop in Brno, Czech Republic.

We are looking for Electronic Repair Engineers, Electronic Repair Technicians and Electronic Component Level Repair Engineers.

- Do you have an interest in electronics?
- Have you any experience in the field of practical electronics?
- Have you experience in Radio/Television/Home Electronics?
- Does your hobby/interest include electronics?
- Are you willing to learn new tricks – electronic engineering?
- Do you want work in an exciting and challenging environment?
- Do you have any experience with Machine Tool Systems - PLC's - Servo Drives - Servo Motors - Monitors-VDU's - AC Drives - DC Drives - Temperature Control - Digital Electronics – Analogue Electronics?

We offer a competitive salary and all the other benefits normal with a go ahead company.

LeKtronix



Please Contact: Mr Brian Stewart
Lektronix Ltd, Unit C1, Anchor Brook Ind Park,
Wharf Approach, Aldridge, West Midlands,
WS9 8EQ, United Kingdom.

Telephone +44 (0)1922 455555 for an application form or apply on line at www.lektronix.net



BitScope USB Mixed Signal Oscilloscope

Analog + Digital

Digital Storage Oscilloscope

- ✓ Dual Channel Digital Scope with industry standard probes or POD connected analog inputs. Fully opto-isolated.

Mixed Signal Oscilloscope

- ✓ Capture and display analog and logic signals together with sophisticated cross-triggers for precise analog/logic timing.

Multi-Band Spectrum Analyzer

- ✓ Display analog waveforms and their spectra simultaneously. Base-band or RF displays with variable bandwidth control.

Multi-Channel Logic Analyzer

- ✓ Eight logic/trigger channels with event capture to 25nS.

DSP Waveform Generator

- ✓ Built-in flash programmable DSP based function generator. Operates concurrently with waveform and logic capture.

Mixed Signal Data Recorder

- ✓ Record to disk anything BitScope can capture. Supports on-screen waveform replay and export.

User Programmable Tools and Drivers

- ✓ Use supplied drivers and interfaces to build custom test and measurement and data acquisition solutions.

Inventing the future requires a lot of test gear...

...or a BitScope



BS100U Mixed Signal Storage Scope & Analyzer

Innovations in modern electronics engineering are leading the new wave of inventions that promise clean and energy efficient technologies that will change the way we live.

It's a sophisticated world mixing digital logic, complex analog signals and high speed events. To make sense of it all you need to see exactly what's going on in real-time.

BS100U combines analog and digital capture and analysis in one cost effective test and measurement package to give you the tools you need to navigate this exciting new frontier.



Standard 1M/20pF BNC inputs

Smart POD Connector



Opto-isolated USB 2.0

12VDC with low power modes

BitScope DSO Software for Windows and Linux

BS100U includes BitScope DSO the fast and intuitive multichannel test and measurement software for your PC or notebook.

Capture deep buffer one-shots, display waveforms and spectra real-time or capture mixed signal data to disk. Comprehensive integration means you can view analog and logic signals in many different ways all at the click of a button.

The software may also be used stand-alone to share data with colleagues, students or customers.

Waveforms may be exported as portable image files or live captures replayed on another PC as if a BS100U was locally connected.

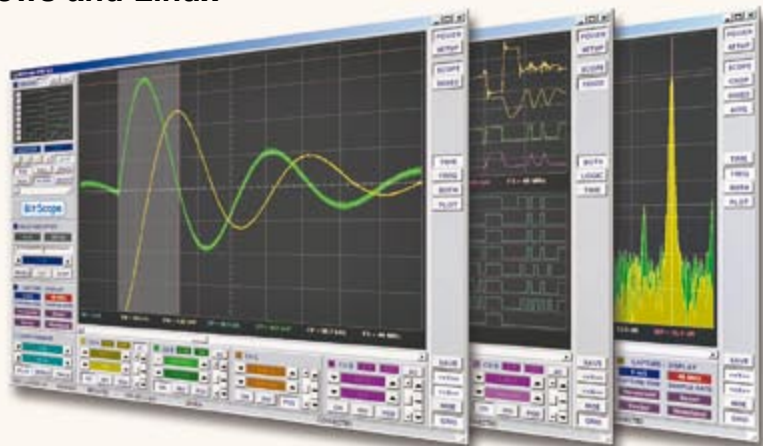

www.bitscope.com

Headphone Amp with 3D Sound

Sound reinforcement for iPod & Co.

Raymond Champlin

The owners of some brands of personal music players complain that the sound reproduction suffers from a lack of volume and has a 'thin' quality. This add-on headphone amplifier solves the problem; it combines a high-quality amplifier with bass and treble boost and a 3D sound effect. Crank it up too high and your eardrums will meet in the middle!

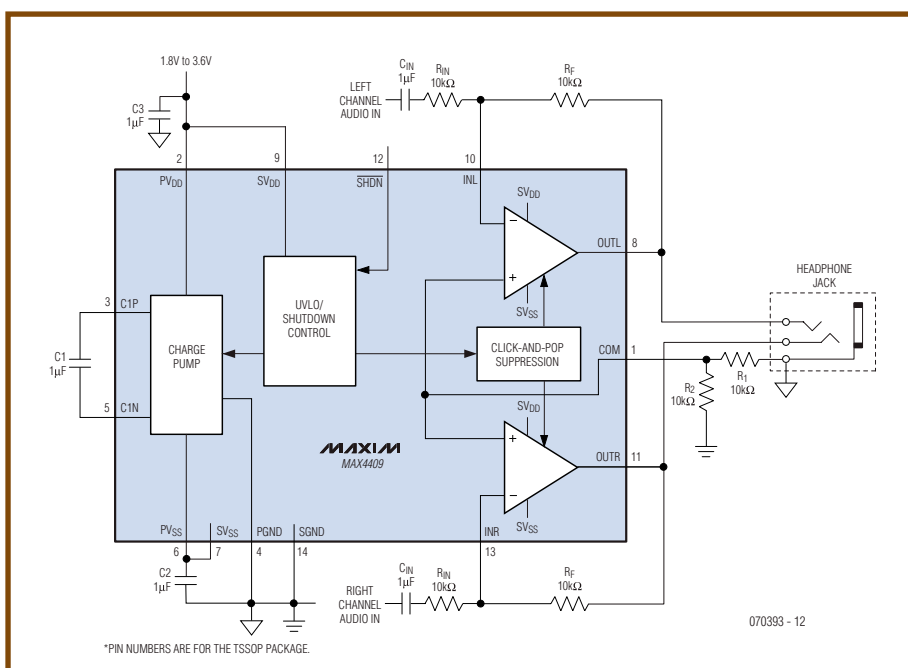

Figure 1. Block diagram of the MAX4409 showing external components.

The ear is particularly sensitive to sounds in the frequency range of the human voice. Frequencies above or below this band are perceived to be quieter and this effect is even more pronounced at low levels of volume. Some audio amplifier designs incorporate 'loudness compensation' which

boosts the bass and treble frequencies at low volume settings so that the tonal characteristics of the amplifier are perceived as being more linear with respect to the volume setting. The headphone amplifier described here combines a high-spec amplifier IC with a discrete transistor front-end giving

additional bass and treble lift together with an audio 3D effect.

The MAX4409

The MAX4409 is used as the main stereo power amplifier for the headphones in this design. This IC can operate with a supply rail in the range of 1.8 V to 3.6 V and has a number of interesting properties. The block diagram in Figure 1 shows that the IC contains an on-board charge pump circuit to generate the negative supply voltage PV_{SS} , used throughout the chip. This almost doubles the dynamic range of the amplifier and allows the output to be biased around ground potential even though it is powered from a single-ended supply. Capacitor C1 in the charge pump circuit is switched at over 300 kHz.

The stereo amplifiers use a class AB output stage and the negative voltage produced by the charge pump allows the amplifier to have symmetrical power rails which removes the need for a large electrolytic coupling capacitor at the output. Each amplifier can supply 80 mW into a 16 Ω load. Headphones with an impedance of 32 Ω will be supplied with more than enough power.

Figure 2. The circuit showing the transistor preamp with tone filters and the MAX4409.

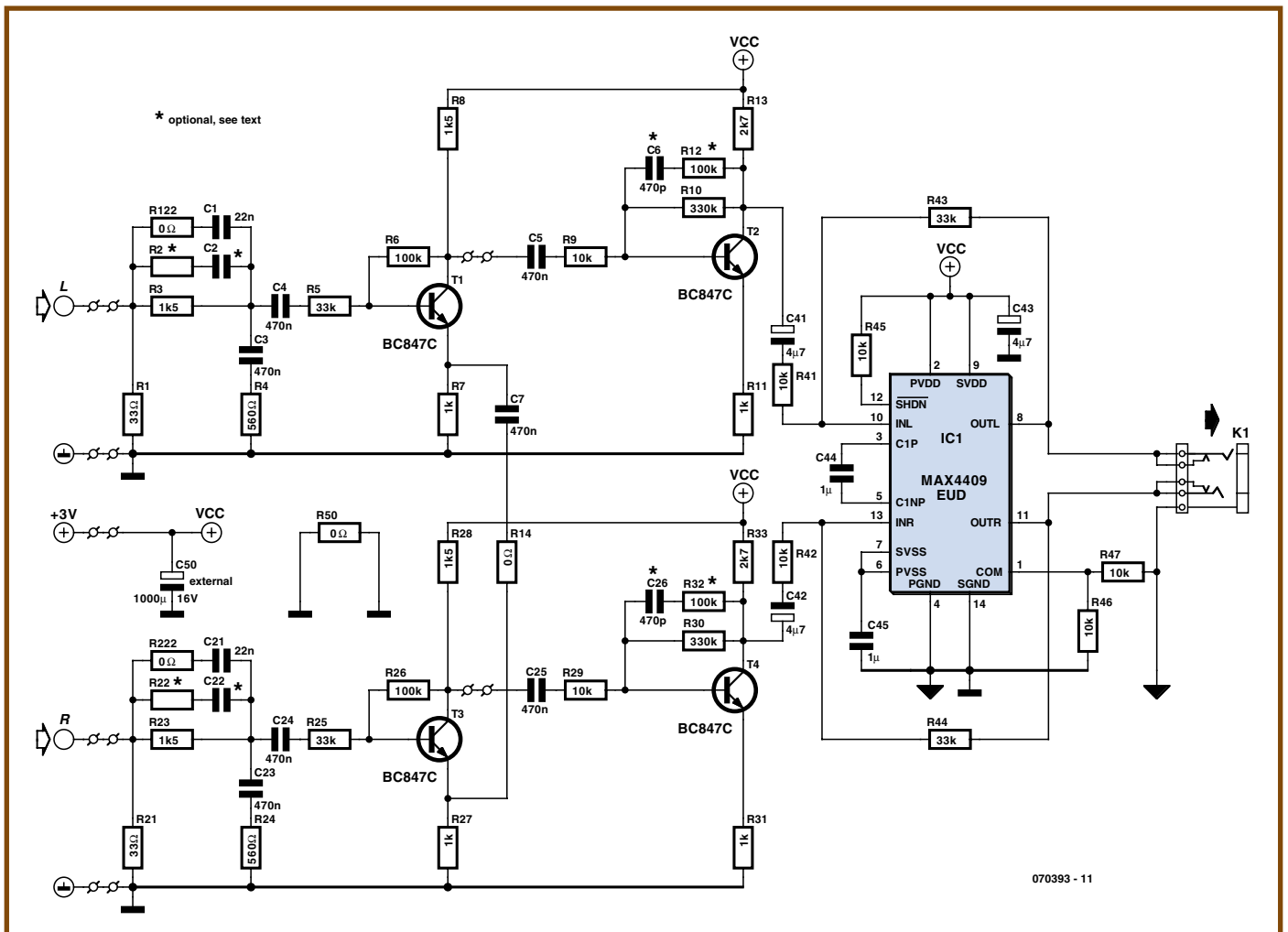

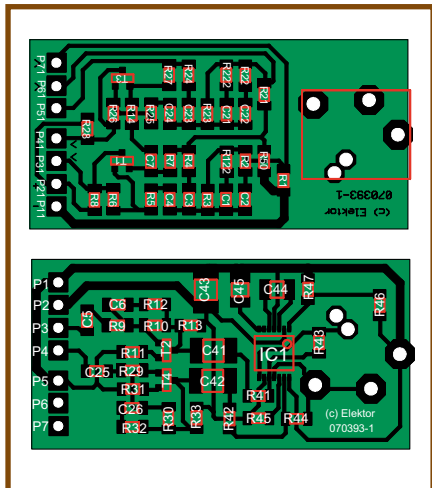

Figure 3. The double-sided PCB accepts SMD components but is not through-plated.

To give some idea of the sound level you can expect from this design, headphone sensitivity (in accordance with IEC 60268-7) is measured with an input power of 1 mW and an average set of headphones would typically produce a Sound Pressure Level (SPL) of around 96 to 100 dB at this input power level. The MAX 4409 can supply 65 mW into 32 Ω so it is unlikely that there will be any complaints of insufficient volume! The distortion figure of the amplifier is below 0.01 % at (almost) maximum power output. A more typical level of distortion (measured at 1 kHz) at 50 mW into 32 Ω is around 0.002 % and 0.005 % for 60 mW into 16 Ω. Both of these figures are many times less than the distortion introduced by the headphones themselves which can have a level of 0.2 % or more.

Other notable features of the MAX4409 are its 'click-and-pop' suppression which effectively prevents annoying switch-on and off noises. It is also worth noting the excellent power supply rejection ratio and the common-mode rejection ratio of 96 dB. The quiescent supply current of the device is just 5 mA.

The preamp stage

The complete headphone amplifier circuit diagram is shown in **Figure 2**. The 33 Ω resistors R1 and R21 ensure that input impedance of the amplifier is equivalent to the load presented by a standard set of headphones. It isn't really necessary to use this value of resistance for any sort of optimal load matching so the value of R1 and R21 can be increased tenfold without any

Components list

Resistors

- (SMD 1206 case)
- R1, R21 = 33Ω
- R2, R22 = see text
- R3, R23 = 15kΩ
- R4, R24 = 560Ω
- R5, R25, R43, R44 = 33kΩ
- R6, R12, R26, R32 = 100kΩ
- R7, R11, R27, R31 = 1kΩ
- R8, R28 = 1kΩ
- R9, R29, R41, R42, R45, R46, R47 = 10kΩ
- R10, R30 = 330kΩ
- R13, R33 = 2kΩ
- R14, R50, R122, R222 = 0Ω

Capacitors

- (SMD 1206 case unless otherwise indicated)
- C1, C21 = 22nF
- C2, C22 = see text
- C3, C4, C5, C7, C23, C24, C25 = 470nF
- C6, C26 = 470pF
- C41, C42, C43 = 4μF7 (SMD 1812)
- C44, C45 = 1μF
- C50 = 100μF 16V radial (can-style electrolytic)

Semiconductors

- T1-T4 = BC847 (SOT-23))
- IC1 = MAX4409EUD+ (14-pin TSSOP; Maxim)

Miscellaneous

- 3.5-mm stereo socket, PCB mount with collet nut
- PCB, order code 070393-1 from www.the-pcbshop.com
- Enclosure

problem. The following RC networks provide bass and treble lift for the audio signals. The network formed by R3 (R23), C3 (C23) and R4 (R24) attenuates signals above 1 kHz to effectively give a bass boost. The network R122 (R222) and C1 (C21) provides a path for higher frequency signals to bypass R3 (R23) to give a treble lift. The additional networks shown as R2 (R22) and C2 (C22) are included in the diagram for future filter modifications above 1 kHz but are not implemented here.

The coupling capacitor C4 (C24) provides AC coupling of the signal to the next transistor stage; this capacitor has a relatively large value to ensure that low frequencies are not attenuated. The gain of this first transistor stage T1 (T3) is quite low, the audio '3D effect' is produced by linking the left and right signals via C7 and R14 at the emitters of T1 and T3. Signals at the higher frequency end of the spectrum in the left channel are subtracted from the right channel signal and likewise signals in the right channel are subtracted from the left. The value of C7 determines the frequency above which this effect is produced. Without this frequency dependency the amplifier output would just be the stereo difference signal so that left and right signals that are in-phase (usually lead vocals for example) and mono recordings would be greatly attenuated. The value of R14 governs the amount of '3D effect' that is produced. C7 can simply be omitted from the circuit if this feature is not required.

The second transistor stage T2 (T4) is AC coupled via C5 (C25) and the gain is governed by the ratio of R9/R10 (R29/

R30). An optional RC network consisting of C6/R12 (C26/R32) can be fitted in parallel to R10 (R30) to provide some attenuation at high frequencies which helps to suppress any problems which may arise from HF interference.

From the second transistor stage the audio signal is again AC coupled via C41 (C42) to the input of IC1. The ratio of R43/R41 (R44/R42) fixes the gain of this amplifier. For the reasons already mentioned the headphones are connected directly to the IC output via the 3.5 mm headphone socket K1.

C50 is a 100 μF electrolytic capacitor with radial leads, it is too large to be fitted on the PCB and is used as a reservoir capacitor connected across the power input on the PCB to act as a low-impedance energy source for the amplifier to improve the reproduction of low frequency signals and reduce the chance of supply voltage fluctuations. The 0 Ω resistor R50 is simply used to bridge over a track.

The PCB

The PCB layout for the circuit is shown in **Figure 3**. The 25 mm x 50 mm board is double-sided but not through plated. The majority of SMD resistors and capacitors are 1206 outline packages. Capacitors C44 and C45 are 1210 and the electrolytics C41, C42 and C43 are 1812. The transistors are SOT 23 outline and the IC is a 14-Pin TSSOP.

The first amplifier stage together with the tone filters are positioned on the underside of the PCB. Connections between tracks on the two sides of the PCB must be made by hand; short lengths of tinned wire are fed through

the board and soldered to the pads on both sides. The audio signals from the first transistor stages on the underside of the board are connected through to the amplifier on the other side of the board using these wire links. It is best to begin mounting components on the topside of the board with IC1. The PCB mounted stereo jack socket uses its mounting nut to secure the assembly into the enclosure.

The wires for the input signals and power are best led out from the underside of the board; this will make it easier to fit into the enclosure.

The enclosure

The amplifier can be fitted into a 129 mm x 40 mm x 24 mm softline enclosure which has a built-in battery compartment. It will be necessary to make two holes along the top edge of the box; a 6 mm hole for the headphone plug and a 3.5 mm hole for the signal input wire. Make sure that the position of the hole for the headphone socket allows the PCB to fit neatly into the enclosure. A slot in the case is also necessary for the on/off switch and this can be made with either a file or a milling machine. A corner of the PCB needs to be trimmed at the connector end to allow it to fit in the enclosure. The inside of the lower half of the case can now

be cleaned up by removing any plastic moulding which will not be required in order to give space to fit the battery holder which takes two AA sized cells. The holder can be fixed in the case with double-sided tape. The two flying leads of the battery clip can be connected to the PCB with the red wire soldered to plus and the black wire to minus.

The audio input cable is terminated with a 3.5 mm jack plug which connects to the external equipment. It is preferably to use a right-angled jack plug to help reduce mechanical stress in the equipment socket. The other end of the wire passes through a hole in the top edge of the case and the leads can be soldered to the earth, left and right inputs on the PCB. Where the cable exits the case it can either be knotted on the inside or fixed with a dab of hot glue to help prevent it from being pulled out accidentally. The cable length can be cut to suit your needs. The 100 μ F capacitor is not mounted on the PCB, its leads should be left long (5 cm approx) with the ends soldered directly to the power supply pads on the PCB. The capacitor can now be positioned into space inside the case and later fixed with some hot glue. The headphone socket can now be pushed through its hole along the top edge and secured with the mounting nut.

The proof of the pudding

The use of a discrete transistor front-end and the MAXIM IC amplifier means that the complete circuit will function even when the individual cell voltage has fallen as low as 0.9 V. This gives a new lease of life to old batteries from equipment with high-energy demands such as digital cameras or GPS receivers (particularly older models) which may still contain sufficient energy to power this design for a reasonable length of time. When the battery voltage falls too low even for this amplifier you will not hear any nasty distorted sounds in the headphones thanks to the built-in low battery threshold detector which cleanly mutes the output.

The results of (unscientific) field tests indicates that the sound reproduced in the headphones was judged to be very good, several of the volunteers were so impressed they wanted to keep the amplifier for themselves.

The amplifier can produce high sound pressure levels so it is worth remembering that listening for prolonged periods at high volume can (eventually) lead to hearing damage.

(070393-1)

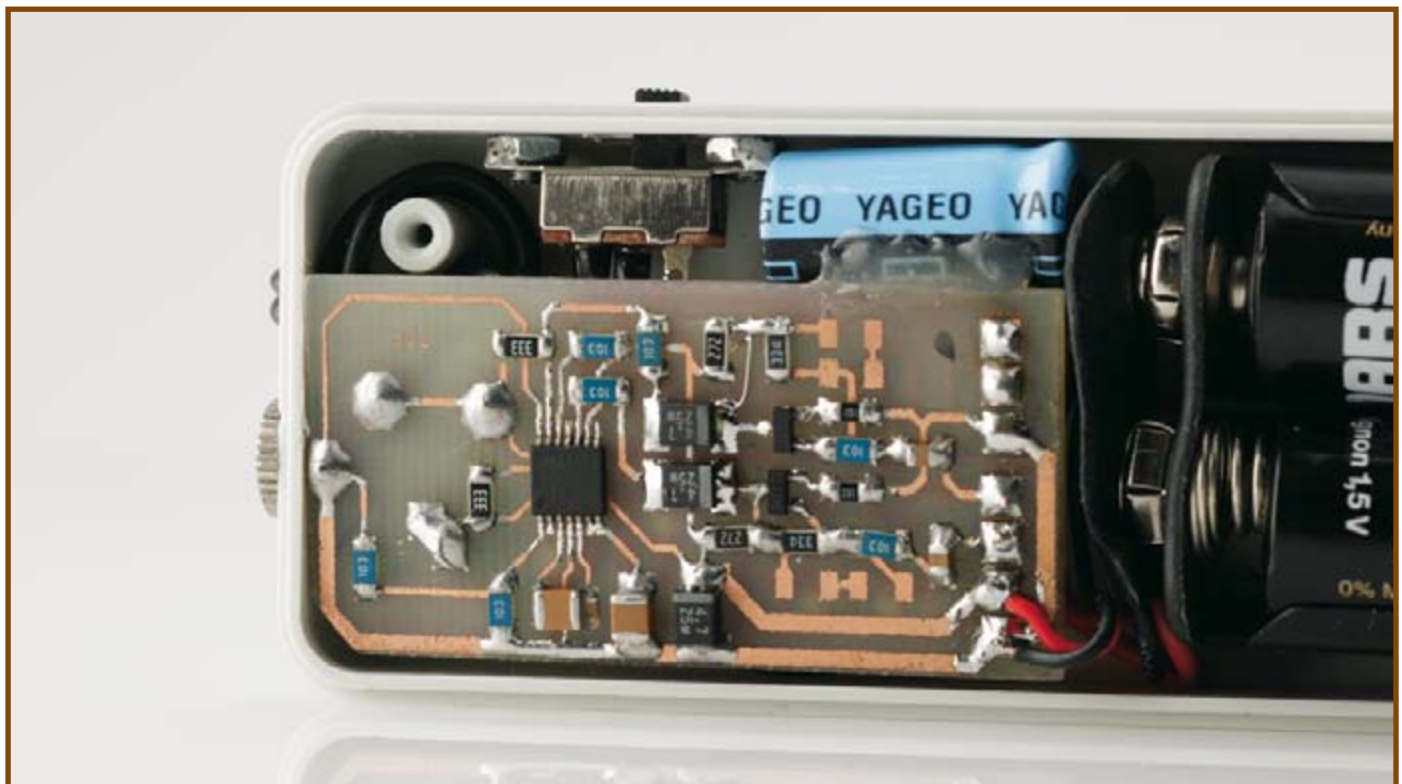

Figure 4. The PCB and battery holder fits neatly into the enclosure.

Tivoli – I lov' it

Quality on the kitchen table?

Thijs Beckers



Design is in. That is true for the world of electronics too. This is clear from the sales figures of the Apple iPod, the Nintendo Wii, the Motorola Razor and other devices with a somewhat stylish design. Henry Kloss and Tom DeVesto understood this well. The men behind the Tivoli Model One have, with this rather old-fashioned appearing design, introduced a table radio into the marketplace that, despite its price, has many eager buyers.

The Tivoli Model One Table Radio is the final product that DeVesto designed together with Kloss, who died in 2002. It is an absolute best seller, despite the hefty recommended retail price of around € 110 (£ 170). Is this elegant wooden box really worth this much or is it only a fancy wrapper? We opened one up and looked at the contents.

Made in China

The little radio looks really as slick as the photo on the website from where we ordered it. All the 'features' can be operated with three nice, large, knobs. The whole design has been kept extremely functional, which was, of course, the intention of the two designers. The rather large amounts of plastic do give it a bit of a cheap feel, however. Still, the decent connections on the back and the

unusually tidy veneered MDF case make ample amends. The case actually looks like it is made from real wood. We don't think it is much of a problem that it is not. After all, MDF is also better suited as an enclosure material for loudspeakers than real wood. On the back we find the text 'Made in China'. This does not necessarily mean bad things, of course. We cheerfully gathered around the radio and open the case as unbiased as possible.

"There's quite a bit in there", is one of the first reactions. "There's even a real bass-reflex port in there and that loudspeaker certainly isn't bad for such a little radio". The speaker strongly resembles an OEM model made by Fostex, but a brand marking is nowhere to be found. The 4-ohm, 5-watt speaker has a substantially sized magnet and quite a wide suspension that permits quite a large excursion of the cone.

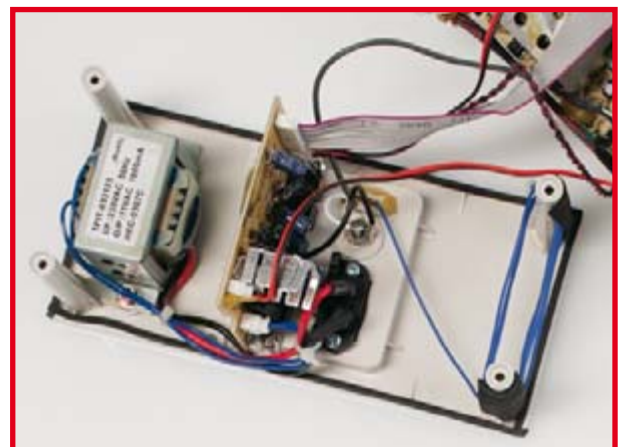



We find three circuit boards on the inside. One for the tuner, one for the power supply and amplifier and a small one that holds the volume and selector knobs. The tuner PCB is quite large. Many discrete parts are used for the construction. Closer inspection shows that a TEA5711T is responsible for the AM/FM reception. We have come across this tuner IC from Philips in portable radios before and it's known for doing a good job. The tuning capacitor is nicely shielded in a tin can. A planetary gear joins the large tuning knob with the spindle of the tuning capacitor.

Rubber bands

The internal antennas work very well. Reception is unbelievably good. Even in the basement of our recently occupied castle, several transmitters (including VHF FM) are easily received. The AM antenna is a wire loop that's attached with rubber bands around the four mounting posts. We do ask ourselves how long those rubber bands will last, but in all likelihood the loop antenna will stay in place anyway, once the radio is assembled. The FM antenna is stretched around two other mounting posts (the blue wire).

You won't find antennas like this in cheap radios. Incidentally, note that it is possible to connect separate external antennas for both AM and VHF FM, if reception proves inadequate.

The radio is fitted with a decent transformer rated at 11 VA. This is mounted on the back, which also contains the power supply/amplifier PCB. The power amplifier is a TDA7266, made by ST. This dual bridge 2x7W amplifier

also provides the stereo headphone output with its audio signal. We find a remarkably large number of opamps on the amplifier PCB. The transfer function shows what they are used for: the high range (around 10 kHz) is amplified by nearly 12 dB and around 100 Hz the signal has received additional emphasis by about 5 dB (see frequency curve). This makes the radio sound much better than the average table radio.

The Tivoli radio can also be powered from 12 V, so that it can be used in, for example, a caravan. It is also provided with reverse-polarity protection so you don't have to worry when connecting it up.

Is the radio worth it?

Indeed, this eye for detail carries through the entire design. We can't find fault with the quality of the construction and the components. There is, for example, a very nice, screened volume potentiometer and there is even an acoustic seal so that the operation of the bass-reflex housing is not compromised. The connections between the PCBs are made with plugs and sockets and not with cheap solder connections.

It really only contains what is necessary for a decent (sound) quality, and not dozens of lights, sliders, buttons and other gimmicks. Not a minimalist design, but just the essential operating controls. The designers did really put a lot of thought into it and invested much effort. Whether that justifies the high price we leave for you to decide.

We do, however, now have a very nice sounding little radio in our lab, because it survived the operation.

(070564-1)

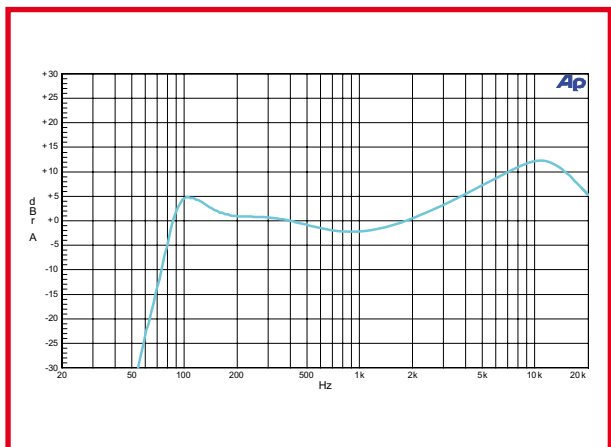
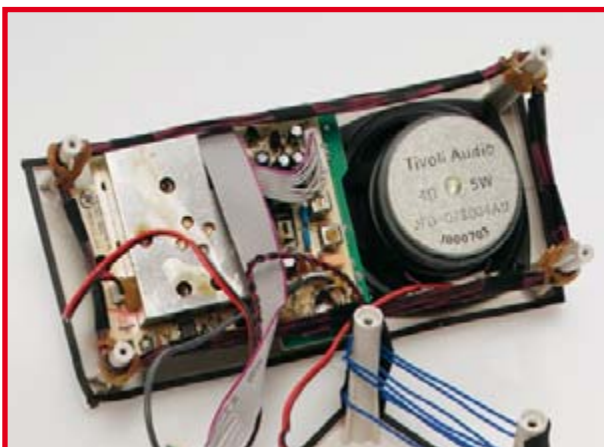

The Challenge

Elektor - Intel 'unplugged' challenge

Wisse Hettinga, Antoine Authier

How can you keep a notebook running for half an hour if you unplug it and remove the battery? It's a simple question, but is there a simple answer?



At Intel they thought this was such an intriguing problem that they asked a number of universities if they could come up with a working solution. The challenge has been accepted by, amongst others, the University of Delft in The Netherlands and now it's a matter of waiting for the results to come in. At Elektor we never shirk a challenge and we expect that a large number of readers will let their imagination run wild and think of possible solutions. With that in mind we called Intel and asked if we could join in too. Unfortunately they declined since they (understandably), didn't want to make 1500 notebooks available, so we decided to take matters into our own hands.

In the Elektor lab we attached a number of meters to a notebook PC with an Intel CPU & chipset. The results of the measurements gave an energy profile for half an hour's use at different processing levels. Surely these figures would be enough to get the keener competitors started?

No sooner said than done. Our challenge for you is as follows: On the bench is a notebook with an Intel processor and the specifications mentioned in this article. Manage to keep this 'unplugged' notebook running for half an hour and you have a chance of winning a notebook or one of five Netgear Rangemax wireless routers.

Be creative: attach a dynamo to your exercise bike, design a new battery, do something with solar cells, make use of gravity, convert your grandfather's clock... We don't mind how you do it, as long as you find a working solution.

Submissions

Submitting your solutions could give rise to some problems, but we can get round these as well. So don't send us your converted exercise bike, but instead document and publish your solution in some way. It could be as a PowerPoint presentation, on a website, a video on YouTube, a Google document, or perhaps you can think of a more original way. From your entry it should be clear that it is a working solution; we like to see some meters incorporated, a notebook in action, or perhaps you could include a burning lamp. We like to be surprised! In the end you'll send us a URL or the actual document. We will select the most original working solutions and choose a winner from those.

The challenge

- Everybody who comes up with an interesting solution can take part.
- Study the energy profile of the notebook.
- Think of and build a working solution.
- Publish your solution in some way and send us the URL, your Google document or a link to your video on YouTube or Internet community, to: editor@elektor.com using this subject: *Intel challenge*.
- You should submit your entry by 31 December 2007.

How and what we measured:

The specifications of the notebook:

- CPU: Intel Core2 Duo T7200 @2GHz, 32 KB cache L1, 4 MB cache L2
- Chipset: Intel 945GM Express
- RAM: 1x 1GB Kingston DDR2 PC2-5300 SO-Dimm module
- Hard Drive: Western Digital Scorpio model:WD1600BEVS (2.5" SATA (1.5 Gb/s), 160 GB, 8 MB cache, 5400 RPM)



Elektor-Intel Laptop's Energy Profile

Mode	Display	CPU core freq.	3D GPU	Audio Power	Stress	Current (mA)	Voltage (V)	Power (W)
Minimum Backlight								
1	on	1 GHz	off	off	none	940	19.00	17.86
2	on	1 GHz	off	off	basic session	1460	18.97	27.70
3	on	1 GHz	off	avg	playing DVD	1660	18.95	31.46
4	on	1 GHz	off	full	playing DVD	1740	18.94	32.96
5	on	2 GHz	on	off	3D benchmark	2460	18.86	46.40
6	on	2 GHz	on	off	basic networking + 3D benchmark	2530	18.84	47.67
7	on	2 GHz	off	off	Full CPU usage	2320	18.88	43.80
8	on	2 GHz	off	avg	Full CPU usage + playing MP3	2530	18.88	47.77
9	-	-	-	-	-	-	-	-
Full Backlight								
1	on	1 GHz	off	off	none	1165	18.98	22.11
2	on	1 GHz	off	off	basic session	1623	18.96	30.77
3	on	1 GHz	off	avg	playing DVD	1860	18.93	35.21
4	on	1 GHz	off	full	playing DVD	1997	18.92	37.78
5	on	2 GHz	on	off	3D benchmark	2690	18.84	50.68
6	on	2 GHz	on	off	basic networking + 3D benchmark	2770	18.82	52.13
7	on	2 GHz	off	off	Full CPU usage	2550	18.85	48.07
8	on	2 GHz	off	avg	Full CPU usage + playing MP3	2790	18.86	52.62
9	on	2 GHz	on	full	Full CPU usage + Full 3D benchmark + basic networking	3300	18.79	62.01

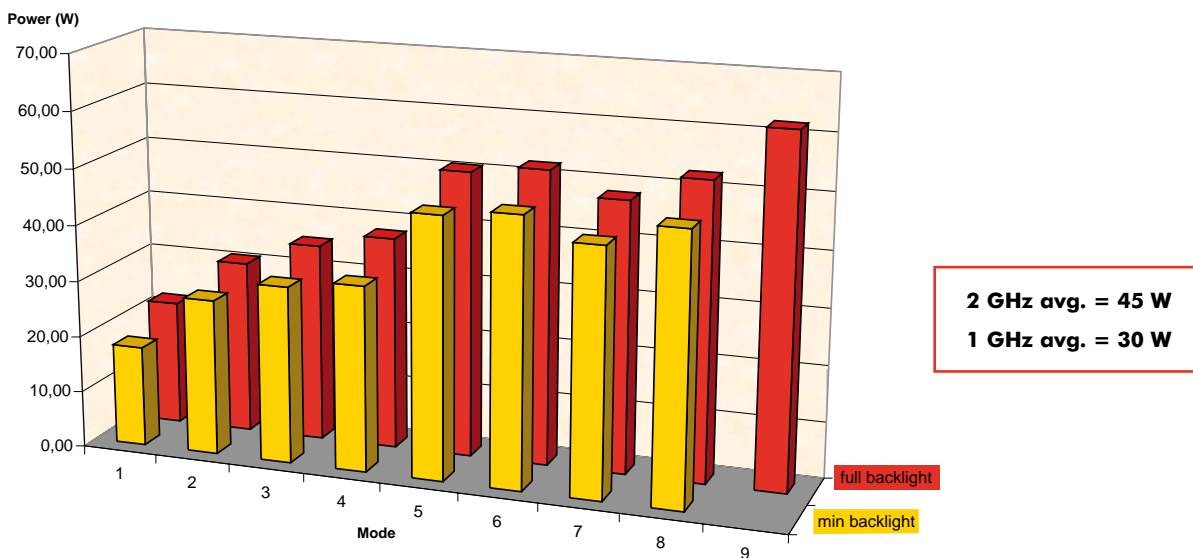

- Optical drive: LITEON model SSM-8535S (Write speed: DVD-R (8x), DVD+R (8x), DVD-RW (6x), DVD+RW (8x), DVD+/-R DL (4x), CDR (24x), CD-RW (24x), Read speed: DVD (8x), CD (24x))
- GPU: nVidia GeForce Go 7600
- Display: 15.1", WXGA TFT display
- Video: S-Video and second monitor support (VGA only)
- Backlight: controller by Asus
- Network: Realtek 8169 Gigabit Ethernet controller
- Wireless: Bluetooth 2.0, no WIFI
- Audio: Realtek ALC883 + Intel H.D.A. support
- External expansion slots: 1 x PCMCIA, 1 x ExpressCard (we think)
- Connectors: 3 x USB 2.0, 1 x FireWire, 1 x RJ45 Ethernet, 1 x IrDA, 1 x SD-card, 1 x microphone, 1 x headphone
- Keyboard: Laptop keyboard
- Touchpad: PS2 Synaptic Touchpad
- Extra: Fingerprint scanner, integrated USB2 webcam, 2 x audio speakers

- External supply: 19 V/4.7A DC
- Battery: 11.1V/4.8 Ah

The energy profile of the notebook can be built from the data measured in the Elektor lab, you find discrete values for a number of typical operations in the above table.

The operating system used during the measurements can be described as: Linux kernel 2.6.20 and an adapted version of the Multimedia Ubuntu distribution.

The prizes

First of all there is a notebook of course, the star of this article. Netgear has generously made five routers available as prizes: the **Rangemax Next Wireless N router WNR834B**, with an RRP of £120 incl. VAT.

(070717-1)

Stay Tuned to G8JC

Peter Carnegie, G8JCF

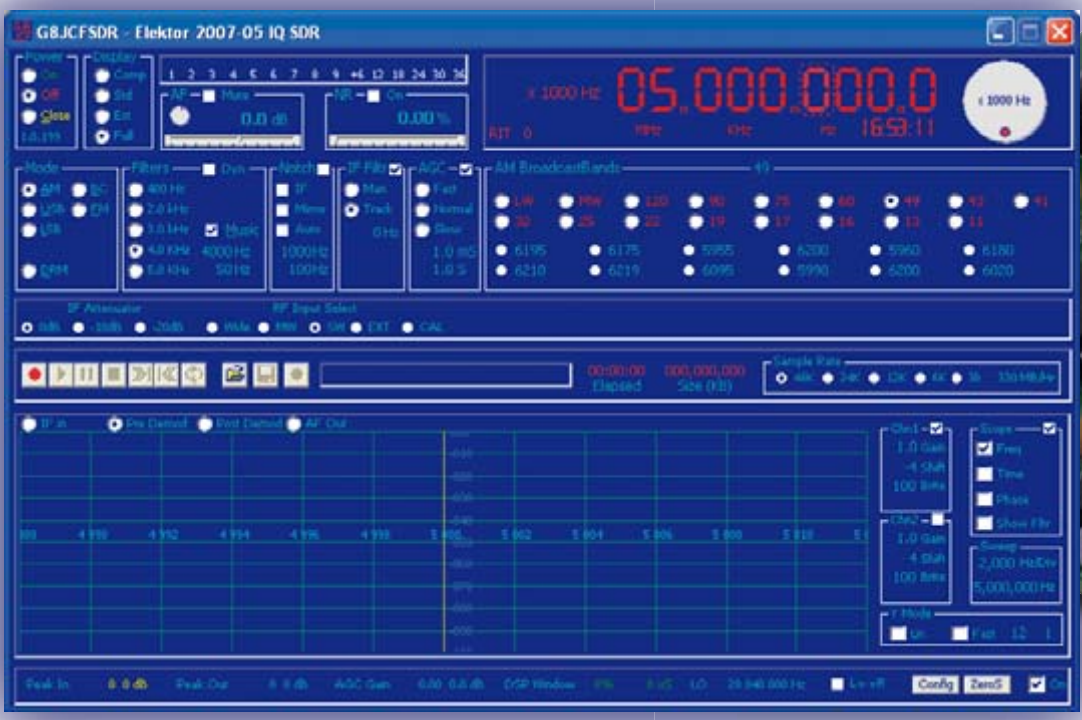

The G8JCFSDR is a software implementation of a conventional radio, using digital signal processing (DSP) techniques. The G8JCFSDR in conjunction with simple down-converter hardware like Elektor's May 2007 SDR (the best, and a real blockbuster) provides an extremely cost-effective, incredibly flexible and versatile receiver combination.



Because the radio is implemented in software, features which would be prohibitively expensive or almost impossible to implement in hardware become simply a matter of programming and CPU/Memory consumption, e.g. fully variable filters with 50 Hz skirts.

The G8JCFSDR is optimised for HF band communications, although with suitable down-converters there is no

reason why other frequency ranges cannot be handled.

The Elektor SDR

This article focuses on using the G8JCFSDR in combination with the Elektor May 2007 IQ USB down-converter. However, much of what is written here applies to any other down-converter. General aspects of the G8JCFSDR program like operation of the controls (slider, dial, frequency, RIT, station presets and so on) may be found in the *G8JCFSDR Build 205+ Quick Start Guide*, which Peter wrote specially for Elektor and may be downloaded from his own homepage [1] as well as from

www.elektor.com at no charge. From a price/performance and feature perspective, the Elektor May 2007 USB down-converter is right up there at the top of the pile, and after 40 years of playing about with radios, this is the first radio I have ever owned which has a calibrated S-meter!

Configuring G8JCFSDR for use with the Elektor May 2007 SDR

The G8JCFSDR software may be downloaded from [1] and remains the author's copyright. If you are running Microsoft Vista then you will also need to install a key file of DirectX8. The file c:\windows\system32\DX8VB.DLL is

FSDR

terrific software for the Elektor Software Defined Radio

not part of the standard VISTA OS and must be manually installed. The simplest thing to do, is to Google for `VISTA DX8VB.DLL DOWNLOAD` and download it. Then register the DLL using `regsvr32 c:\windows\system-`

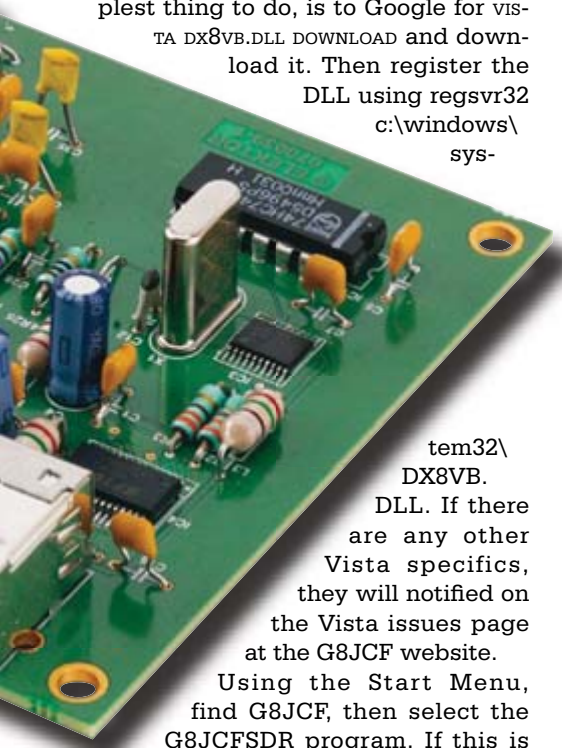

tem32\
DX8VB.

DLL. If there are any other Vista specifics, they will notified on the Vista issues page at the G8JCF website.

Using the Start Menu, find G8JCF, then select the G8JCFSDR program. If this is the first time you have ever run the G8JCFSDR, then it will initialise itself to default values. Make sure the G8JCFSDR is set for Full display, click on the Full radio button: **Figure 1**.

The G8JCFSDR should look something like the screenshot in **Figure 2**.

The most important item to change is the Spectrum Analyser screen display mode from Linear mode to Logarithmic mode. Make sure the check box marked LIN is **unchecked**. Then same applies to the checkbox called Fast: **Figure 3**. Next, set the scope display to Spectrum Analyser mode by clicking on the Freq checkbox. Also make sure the Show Filtr checkbox is checked so that you can see which frequencies are being received: **Figure 4**.

Next, turn on the Performance Stats. Click the On checkbox as in **Figure 5**. Click the Close radio button to close down G8JCFSDR and save your settings: **Figure 6**.

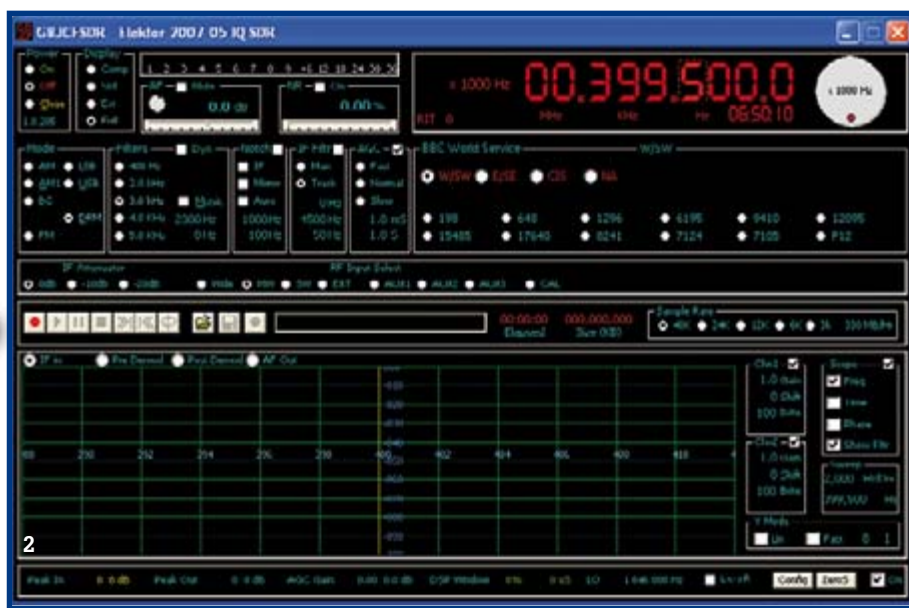

Restart the G8JCFSDR from Start | Run or your Start Menu item. Check that that settings you just changed have persisted, i.e. Ymode, Scope and On for the Performance Stats.

Configuring the G8JCFSDR

Next you have to configure the G8JCFSDR for the *Elektor May 2007* USB IQ SDR hardware. Click the Config button, see **Figure 7**.

The Configuration window should be displayed: **Figure 8**.

Select the *Elektor 2007-05* IQ SDR from the SDRModel dropdown list. While you are here, you may as well make sure that the Keyboard Support checkbox is checked, and that the Auto-Track Presets checkbox is checked. Make sure that all the other checkboxes are unchecked.

Next, you should select the soundcard. Click on the Soundcard tab. The Soundcard tab will be displayed as shown in **Figure 9**.

If you have several soundcards installed, then select the one into which

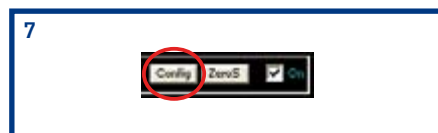
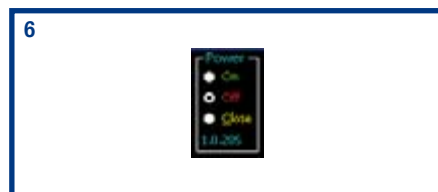
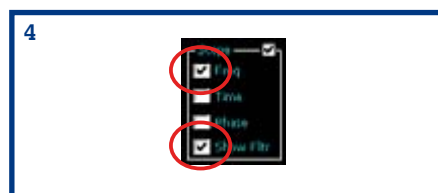

8

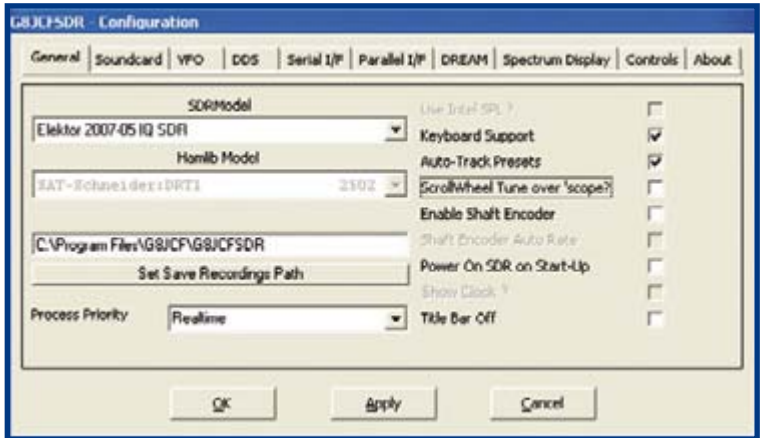

you have plugged the audio cable from your *Elektor* SDR board. If you only have one soundcard, then leave the settings at the default settings. Make sure that you MUTE the Line-In on the Playback settings for your soundcard, and that you have selected Line-In on your Recording Settings.

9

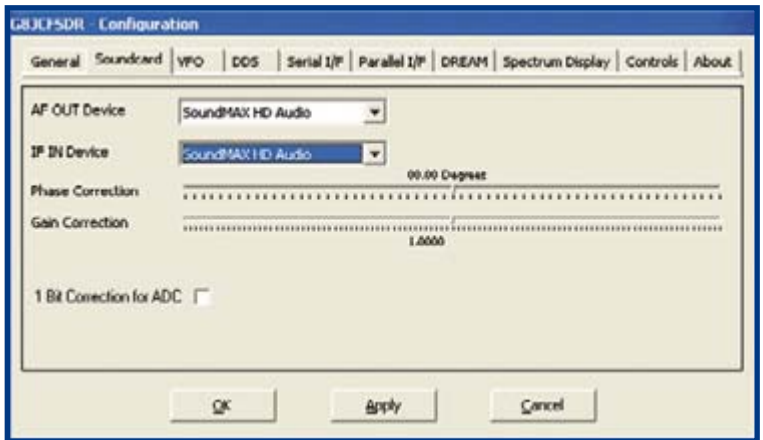

Next, the VFO parameters need configuring. Click the VFO tab and make sure all of the values are as shown in **Figure 10**.

Next, the Interface to the CY-27EE16 chip must be configured per **Figure 11**.

Click and select the FTDI FT232 DDS I/F Control. Set the CY27EE16 Xtal Capacitance slider about halfway. For now leave DDS Auto Refresh unchecked. The DDS Clock entry is not relevant for the ELEKTOR 2007-05 SDR and should be left at the value shown.

The rest of the tabs in configuration may be used later to change colours, configure use of DREAM.EXE and so on. For now these options don't matter.

Click Apply, then click OK. Close and Restart the G8JCFSDR to make sure that the configuration changes you have just made are persisted.

10

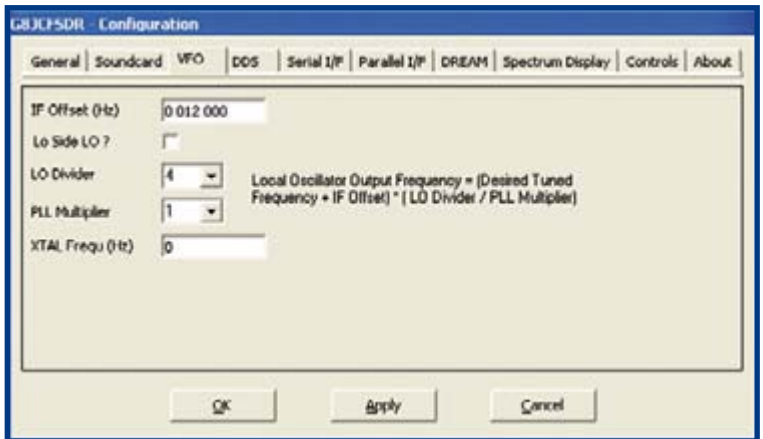

Calibration & Corrections

Image Rejection, calibration, phase correction, amplitude correction, frequency calibration and S-meter calibration are discussed in great detail in the *Quick Start Guide* to which interested readers are referred.

11

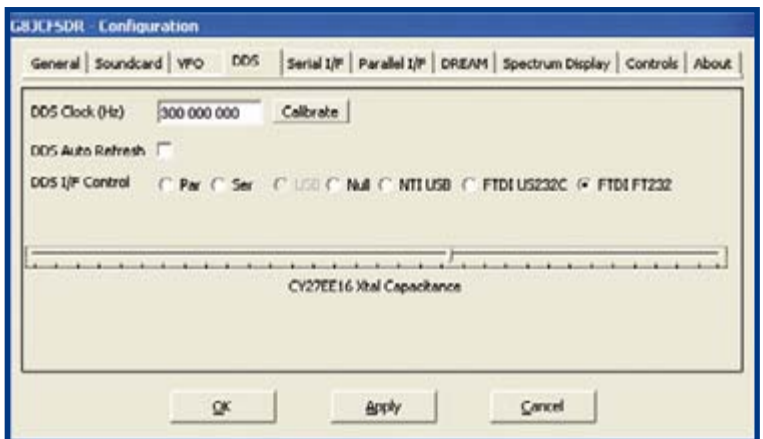

DRM

If you want to listen to DRM broadcasts then you need to configure G8JCFSDR to use DREAM.EXE. Click the Config button to bring up the Configuration window, then select the DREAM tab, see **Figure 12**.

Use the Browse button to locate your copy of DREAM.EXE. Next, check the checkboxes as desired. The settings shown are reasonably good, but of course it's up to your preferences. The options are listed up in **Table 1**.

When Dream.exe is started, you can choose how it appears on the screen. If you choose Default, then Dream.exe will start up however it was last displayed. If Min is selected, then Dream.exe will start up minimized to the Taskbar. If Hide is selected, then the program will start up hidden and you

won't be able to see it. The best option probably is to select Min.

The greyed area is automatically set by G8JCFSDR when Dream.exe is run including "-C 3" for IQ mode. The second box enables you to supply any additional options which you want to Dream.exe. %CURFREQ% is a special argument, when Dream.exe is run, G8JCFSDR will replace %CURFREQ% with the actual operating frequency in kHz.

After you have made any changes, then press Apply, then Press OK.

12

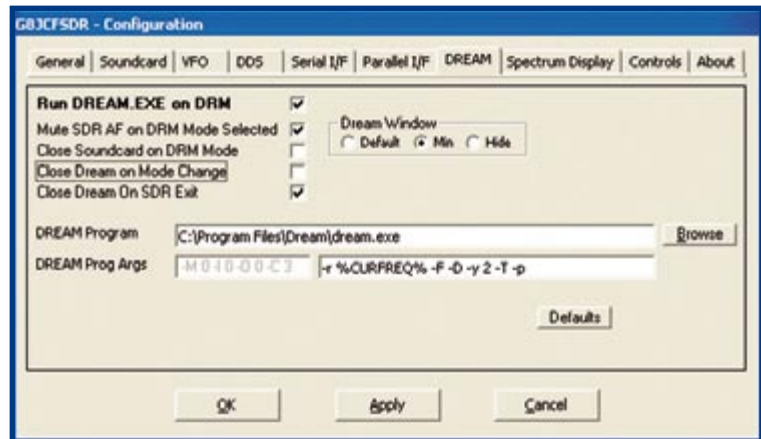

CQ de G8JCFSDR on forum

All users of the *Elektor* May 2007 SDR are expressly invited to discuss the project in the specially created topic at www.elektor.com/forum. Best 73s!

(070565-1)

Web Link

[1] <http://www.g8jcf.dyndns.org>

Table 1.

Run DREAM.EXE on DRM	When DRM demodulation mode is selected on the G8JCFSDR, DREAM.EXE is automatically executed
Mute SDR AF on DRM Mode Selected	When DRM demodulation mode is selected, mute the G8JCFSDR's audio output
Close Soundcard on DRM Mode	When DRM demodulation mode is selected, release the soundcard so that DREAM.EXE can use it – Required for Windows 98 – leave unchecked for Windows XP
Close Dream on Mode Change	When a different demodulation mode than DRM is selected, close the Dream program – usually best to leave this option unchecked.
Close Dream On SDR Exit	If Dream is running when the G9JCFSDR is Closed, then also close down Dream.exe

Advertisement



Antex offer a wide choice of input voltages and bit profiles for our soldering iron range

visit: www.antex.co.uk



60+ years of experience

It may surprise you but buying an Antex soldering iron costs less than you think in the long run. British made to exacting standards, they last significantly longer than many imported brands. With a wide range of thermally balanced models, and temperature controlled irons too, you can always be sure to find an iron that meets your needs.

A large range of replacement tips are available for most irons, and technical help is on hand from our offices in Devon UK.

Buy Online

Our new website has all of our irons, and soldering spares and accessories available 24hrs a day. Most items are shipped next day, and we offer free carriage throughout Europe. Why not give antex.co.uk a try!

www.antex.co.uk
FREE shipping on all orders

Antex Electronics Ltd
 2 Westbridge Industrial Estate
 Tavistock, Devon PL19 8DE, UK
 Tel: +44(0)1822 613565
 Fax: +44(0)1822 617598
 Email: sales@antex.co.uk
 Web: www.antex.co.uk

Low-cost Heating Controller

Minimum outlay, maximum payback

Ingo Busker & Holger Buss

Before winter gets a grip it's probably time to give your heating system the once-over. Older boilers are not especially efficient but the cost of replacement is not trivial. The low-cost heating controller presented here measures flow temperature and outdoor temperature to run the boiler more efficiently. Good news for your bank balance and the environment!

Older types of central heating boilers are usually equipped with very rudimentary temperature controls: A manually adjustable knob fitted to the boiler control panel sets the circulating water temperature while a room thermostat switches the boiler off when the room gets up to temperature. Altogether not too sophisticated, there is no external thermometer to sense the outdoor temperature and no 'night set-back' facility which automatically reduces room temperature setting a few degrees at night while everyone sleeps. When the weather turns really cold it may be necessary to increase the flow temperature to ensure the radiators can keep all the rooms warm while during milder spells a decrease of flow temperature will help maintain a more constant room temperature and reduce fuel consumption. In the age of automation and computer control it seems a bit incongruous to resort to manual adjustment of the boiler thermostat to keep up with the changing weather conditions. In addition, turning down the thermostat at night or when you go away can often be overlooked, resulting in fuel wastage.

Tame that boiler

With painful memories of last winter's heating bill at the back of the mind the homeowner may well be casting a critical eye over the state of the heat-

ing equipment at this time of year. It is always advisable to get the system checked annually by a professional. The system may prove to be perfectly serviceable in which case you are faced with the decision of whether to replace the boiler with a newer, more efficient model (the cost of this option is likely to be a minimum of one thousand pounds) or fit the existing boiler with a new control system which reduces the amount of fuel the boiler uses.

This article concerns itself with the second option and describes the construction of a flexible, programmable heating control unit which takes into account the outdoor temperature. The control unit is unlikely to transform a vintage boiler from the 1960s into a super efficient 'A rated' appliance but for newer boilers which have just simple controllers significant savings can be made. The author fitted it to his home heating system which itself dates back to the 1970s and benefited from a 40 % (!) reduction in gas use over the year. The cost of the controller should work out at less than £ 70 (aprox. € 100) and with the price of gas getting ever higher it certainly won't take too long to recoup the outlay.

The software and hardware developers are both graduate engineers and have attended their local computer club since way back in the days of the C64.

More recently they developed an AVR-Ctrl single board computer which has been the basis for a number of projects including this heating controller. More information is available from their web site [1]. An unpopulated PCB for the AVR-Ctrl is also available from the Elektor SHOP.

The microcontroller board

As the name suggests, the AVR-Ctrl board is based around an AVR controller from Atmel, the board can accommodate many different types of the Atmel AVR family of microcontrollers. Development of the heating controller firmware started with the AT90S/ATMega8535 type controller which the author later replaced by the newer ATMEGA32. The AVR-Ctrl PCB is a general purpose development platform which did not require any modifications for this application. The temperature sensor IC3 (DS18S20) and the IR receiver type SFH506-36 (D2) are marked with an asterisk to indicate that they are not used in this application and need not to be fitted.

The largest component on the diagram is IC1 the ATmega32 controller with its crystal Q1 and capacitors C1 and C2. IC2 is an RS232 interface chip which

Figure 1. The AVR-Ctrl circuit diagram.

ntroller

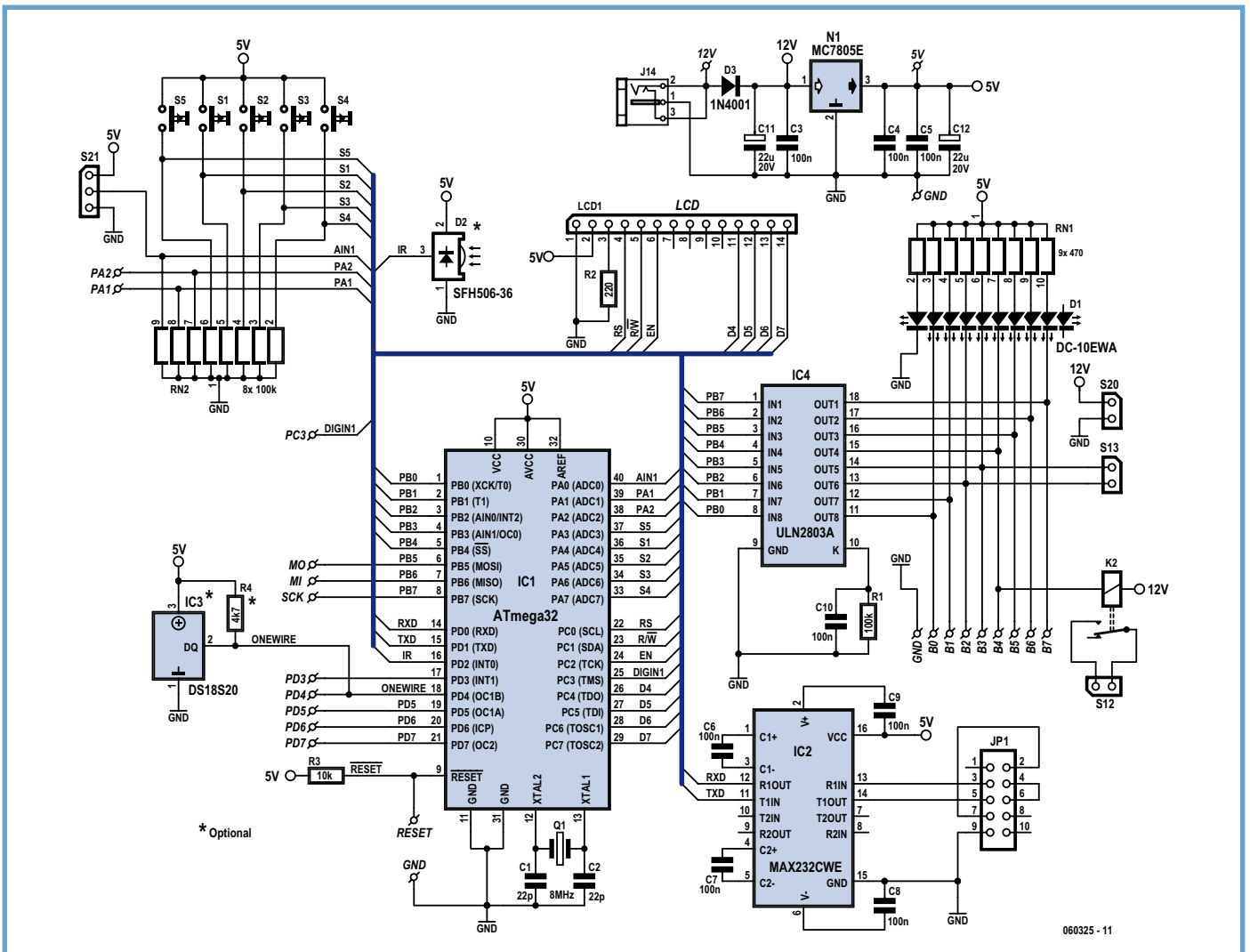

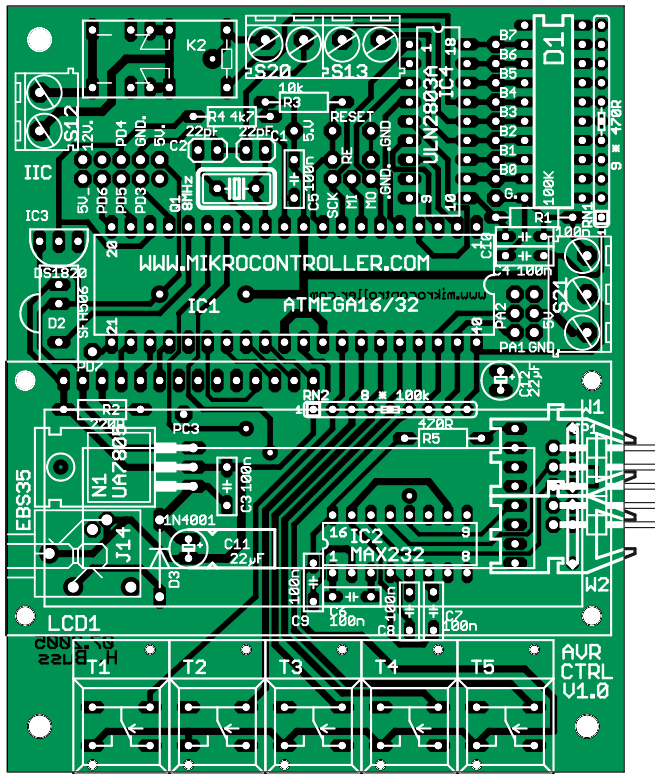
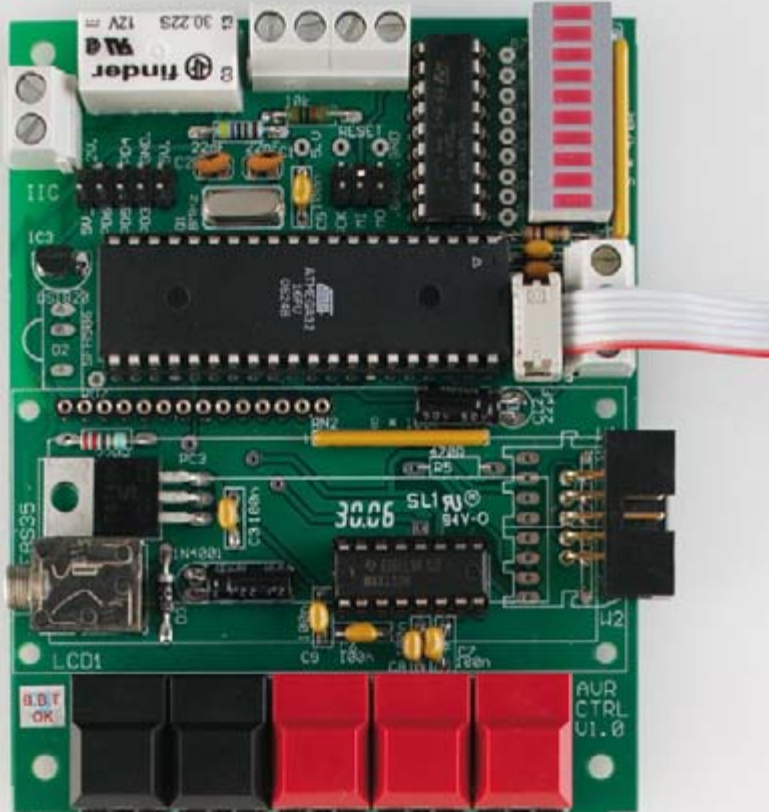

Figure 2. component placement of the double-sided PCB.



COMPONENTS LIST

Resistors

- R1 = 100k Ω
- R2 = 220 Ω
- R3 = 10k Ω
- R4 = 4k Ω
- RN1 = 10-way SIL array 470 Ω
- RN2 = 8-way SIL array 100k Ω

Capacitors

- C1,C2 = 22pF
- C3-C10 = 100nF
- C11,C12 = 22 μ F 20V

Semiconductors

- D1 = DC-10EWA LED bargraph (Kingbright)
- (D2 = SFH506-36, 36kHz IR receiver, Infineon)*
- D3 = 1N4001
- N1 = MC7805BTE (Fairchild Semiconductor)
- IC1 = Atmega32 (Atmel), programmed, Elektor order code **060325-42**
- IC2 = MAX232CWE (Maxim/Dallas Integrated Products)
- (IC3 = DS1820 (Maxim/Dallas Integrated Products)*
- IC4 = ULN2803A (e.g. ST, TI, ON)

Miscellaneous

- Q1 = 8MHz quartz crystal, HC-49U case
- K2 = relay, 1 nc contact, 12V/2A (e.g. Reichelt # FIN 30.22.9 12V)
- S1-S5 = pushbutton, ITT Schadow (Reichelt # DIT 1 XX) (alternative: rotary encoder with push function)
- LCD = 2x16 characters, with LSI KS0070B (e.g. Displaytech 162CBCBC from Reichelt) with 14-way SIL connector set
- JP1 = boxheader 2x5 pins, angled
- JP14 = mono socket, 3.5mm, PCB mount (e.g. Reichelt # ESB35)
- S12, S13, S20 = 2-way PCB terminal block, 5mm lead pitch
- S21 = 3-way PCB terminal block, 5mm lead pitch
- DIL IC sockets, 16-, 18- and 40-way (1 of each)
- PCB, order code **060325-1** from www.elektor.com

Suggested parts supplier: www.reichelt.de

External parts

- K3,K4 = relay, 1 nc contact, 12V/2A
- Rocker switch, on/off
- R8,R10 = 1k Ω
- R9,R11 = KTY81/110 (NXP)

provides level-shifting of the signals to and from the PC. An LCD is connected using the connector strip LCD1. IC4 is an 8-way output driver type ULN2803 which buffers signals from the PB controller port to drive the relays and LEDs. The controller status is indicated on a 10-way LED bar graph. The LED series resistors are contained in the

network RN1. The heating controller firmware only uses five LEDs (on O/P lines B0 to B4) so for this application RN1 and the LED bar graph can be replaced by five discrete LEDs and resistors.

On the input side there are five keys S1 to S5 together with a pull-up resistor network RN2, these keys form the user-interface to the controller. Alternatively a rotary encoder with a pushbutton can also be used on the controller board, it connects to the analogue input at connector S21. The on-board power regulator is completely standard; the 12 V DC input is used for one side of the relay coil connec-

all the joints inspected the board can be connected to a 12 V supply. Use a DVM to check that 5 V and ground are supplied to the corresponding pins on each IC socket. When everything is in order turn off the power and fit all of the ICs and the display into their sockets. At power up a greeting should now be shown on the display.

Integration

The components shown in **Figure 3** are external to the controller enclosure. R9 is a silicon temperature sensor type KTY81/110 used together with linearisation resistor R8 to measure the boiler flow temperature. The second

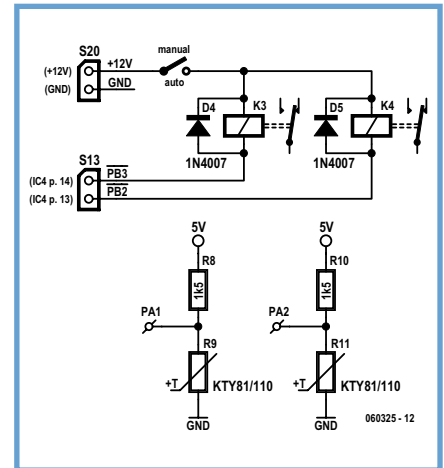

Figure 3. External components for the heating controller.

Main features of the heating controller

- Boiler temperature adapts to outdoor temperature
- 3 operating modes (Night, Day, Out)
- Each operating mode has programmable characteristics
- A total of 64 programmable timers (in 2 independent groups)
- Four timers for work days and a single timer for each weekday
- Automatic night set-back
- Hot water circuit pump control
- Clear menu layout
- Circulating pump control in night mode
- Display the last five days heating usage on LCD
- Storage of daily usage and average daily temperatures for the last 130 days
- Download all stored data via serial interface
- All parameters and usage data are stored in EEPROM
- Optional use of a rotary encoder
- Manual switching between operating modes (Night, Day, Out)
- Controller override by safety switch
- Remote display via serial interface
- All controller firmware including the source code and Windows program free to download

tions and also at the input of the 5 V regulator (N1).

Although the controller board is already fairly minimal there are possibilities to reduce the hardware even more: in addition to being programmed from the switches (or rotary encoder) it can also be controlled by a PC (or another AVR-Ctrl board). When the controller board is operated locally using the on-board keys and display then it is not necessary to fit IC2 or capacitors C6 to C9. Remote operation from a PC or AVR-Ctrl board means that the keys and display can be omitted. Ensure that resistor network RN2 is always fitted to prevent the inputs floating. S1 is not used in this application.

Sockets can be used for all the ICs on the double-sided PCB (**Figure 2**) except for the voltage regulator. Once all the IC sockets and components have been soldered in place on the PCB and

sensor, R11, with linearisation resistor R10 senses the outdoor temperature. The sensors are connected to the microcontroller PA1 and PA2 inputs. The connection pads are positioned in between connector S21 and IC1 on the PCB, connections for +5 V and ground are also provided here. R8 and R10 are soldered on the PCB to PA1 and PA2 respectively with the other ends soldered to +5 V. Cables to the sensors R9 and R11 are connected to PA1 and PA2 respectively with the shields connected to ground.

The outdoor temperature sensor (R11) is best fitted somewhere sheltered and away from direct sunlight. A shielded cable should be used to connect the sensor to the controller with the shield earthed. To further reduce the risk of picking up unwanted signals the cable should be kept as short as possible. The boiler flow temperature sensor R9 is fitted on the boiler flow pipe

where it leaves the heat exchanger. The existing boiler temperature control sensor is fitted in this area also, it normally takes the form of a thin copper capillary pipe with a copper bulb at one end which slides into the heat exchanger casting, the other end goes



Figure 4. Shielded cable is used for the KTY81 sensors.

back to the control knob. The KTY81 heat sensor must be securely attached to the flow pipe with a suitable cable clamp and the shielded cable is fed back to the controller.

On the output side of the controller board are drivers for a relay to control the burner and another to control the pump. An additional relay (K2) is fitted to the PCB which can be used to expand the scope of the controller, for example to control the hot water supply heating. Positioning of the external relays and sensors will be governed by the layout of your particular boiler. Every type of boiler has a slightly different layout; the important thing is that you must be able to identify the boiler components and be sure to correctly make the necessary wiring changes. It is also important to ascertain whether the boiler is suitable for use at a lower operating temperature. Before the existing boiler wiring is investigated it is important to ensure that power to the boiler is properly disconnected. **Mains voltage is lethal**, please follow the safety guidelines regularly printed in *Elektor* and observe local electrical regulations. The body of the boiler thermostat should have two wires connected to it, current through the wires is interrupted when the boiler reaches the set temperature and this releases a relay contact which shuts off the gas valve. This thermostat should be retained but with its temperature setting turned up to maximum. The existing relay should now always be closed and the relay in the new controller (in series now with the old one) will take over control of the gas valve. The function of the old thermostat will still be used; if for any reason the new controller should fail, the old thermostat will act as an over-temperature switch to cut out the boiler when the flow temperature gets too high. With the manual/auto switch (**Figure 3**) set to manual mode the two relays are disabled and the boiler reverts back to control by the old manual thermostat.

In the same manner, a second relay is connected in series with the power supply to the circulating pump. This reduces power consumption by turning off the pump when the boiler temperature dips below a preset level (also quieter at night). Relay K2 can be used to turn off heating to the hot water at night (no emergency override has been incorporated here). **Figure 3** shows the relay wiring, ensure that the polarity of

the freewheel diodes D4 and D5 across the relay coils is correctly observed (the cathodes are connected to +12 V via the manual/auto switch). The normally-open relay contacts for the hot water control are available at S12. The external relays must be housed in insulated enclosures fitted with strain relief grommets for cable entries. It is practical to use plugs and sockets to connect the low voltage wiring from the control board to the sensors and relays. The author used a single sub-D connector on the prototype controller.

Software

The heating controller will of course only work when the firmware has been loaded to the microcontroller IC1. A pre-programmed ATmega32 can be ordered from the *Elektor* online SHOP or alternatively for those of you who can program the microcontroller yourself the firmware is available for download free of charge from the *Elektor* website. Pads on the PCB (next to the crystal oscillator) provide connections for the in-system programming (ISP) interface for the microcontroller MI (MISO) MO (MOSI) SCK (Clock) RS (Reset) and GND (Ground).

A simple programming adapter for ATmega controllers which connects to a PC serial port was described in the May 2006 edition of *Elektor Electronics* and is part of the 'Easy AVR kit' available from our online shop. Alternatively there is a description of ISP programming (using PonyProg) on the author's web page [2] from where software for this project can also be downloaded. There are also two remote control programs available: one uses another AVR-ctrl board and the other runs on a PC under Windows and offers a number of additional features:

- Display curves of the heater readings
- Display the stored operating readings
- Allows change of parameters to optimise heat regulation

Parameter entry with three keys

Programming this flexible controller using just three keys (or rotary encoder with pushbutton) and a small LCD can be accomplished with the logical menu layout. The control keys are marked '-' (S2), '+' (S3) and 'Enter' (S4) (or left/right rotation and press of the rotary

encoder). The description uses the following abbreviations and symbols:

Tb = Actual boiler flow temperature.
To = Outdoor temperature.
Tt = Target boiler flow temperature.
* = Symbol indicating operating mode (Sun symbol= Day, circle (filled) = Night, circle (not filled) = Out (unoccupied))

Status menu

Th 15:31 * 67%
To = +3° Tb = + 50°C

Shows the day and time the next symbol shows the operational mode. The next figure indicates how long the boiler has been heating expressed as a percentage over the whole day. The second row shows the outdoor temperature and the boiler flow temperature. Occasionally the target boiler flow temperature Tt is displayed.

Keys

- / + : Exit menu
Enter: Current time and day of the week.

Timer setup menu

WD *07:00 *08:00
1 *17:00 *22:00

Top left shows the weekday (Mo - Fr, Sa, Su and WD for weekday), next is the timer value. The symbol before the time indicates the operational mode. (e.g. 'Sun symbol' 07:00 = daytime operation starts at 7am.). For each day up to four timer periods are programmable.

This menu is exited when you have cycled through all the days.

Keys:

- / + : Change weekday
Enter: Timer period (with - / +)
An arrow indicates the selection, use 'Enter' to make the change.

Timer setting

Mo 07:00 *
Mode Day

Allows the operating mode times to be altered (Day, Night, Out, Inactive).

Keys:

- / + : Change value
Enter: OK

Switching group menu

The software uses two sets of timer times which can be easily switched (ideal for shift workers!)

Keys:

- / + : Select group

Enter: Exit

Heating curve menu

* 79° at -10°
30° at +21°

The boiler heating characteristics can be entered here. Above left is the maximum target boiler flow temperature while underneath is the minimum target flow temperature. The figures to the right are the corresponding outdoor temperatures. Software added hysteresis reduces on/off burner switching. The heating curves can best be interpreted when the Windows program is used.

Keys:

- / + : Change operating mode

Enter: Change value

Water pump menu

Pump off *

Night $T_b < +33^\circ\text{C}$

For each operating mode the circulating pump can be programmed to cut out when the boiler flow temperature falls below a preset level. A hysteresis is built into this value. To inhibit this feature set the temperature to a high value (e.g. 80 °C).

Keys:

- / + : Change value

Enter: change mode

Energy consumption menu

The heating usage for each day (in percent) and the average outdoor temperature. Values for the last five days can be displayed. The last 120 days values are stored in EEPROM, and can be read using the Windows program.

Mode (key S5)

This key makes it possible to jump between modes independent of menu, day time and weekday.

Change parameters in Windows

Interface to the heating controller using the Windows program (Figure 5) is much more user friendly. Parameters can be changed at will and temperature curves displayed.

The remote control program (Figure 6) can be entered from the consumption menu. Parameter entry is similar to local parameter entry as described above. The consumption figures are also stored in Excel compatible format. The COM setup can be configured from 'Setup'.

(060325-1)

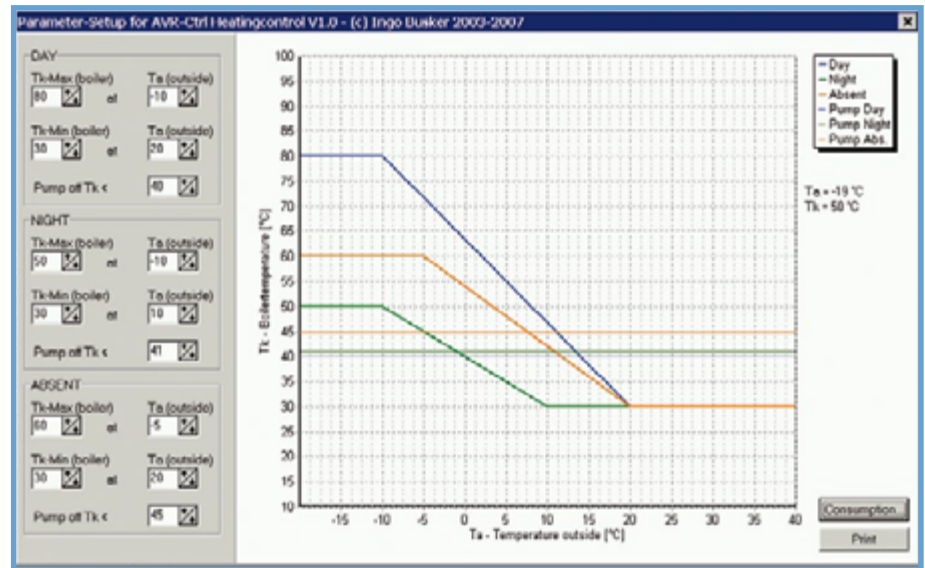

Figure 5. Representation of heating curves using the Windows program.

Web Links

[1] Author's homepage:

www.mikrocontroller.com

AVR-Ctrl project:

<http://mikrocontroller.cco-ev.de/eng/avr-ctrl.php>

Heating controller:

<http://mikrocontroller.cco-ev.de/eng/heizung.php>

[2] PonyProg and ISP info:

<http://mikrocontroller.cco-ev.de/eng/isp.php>

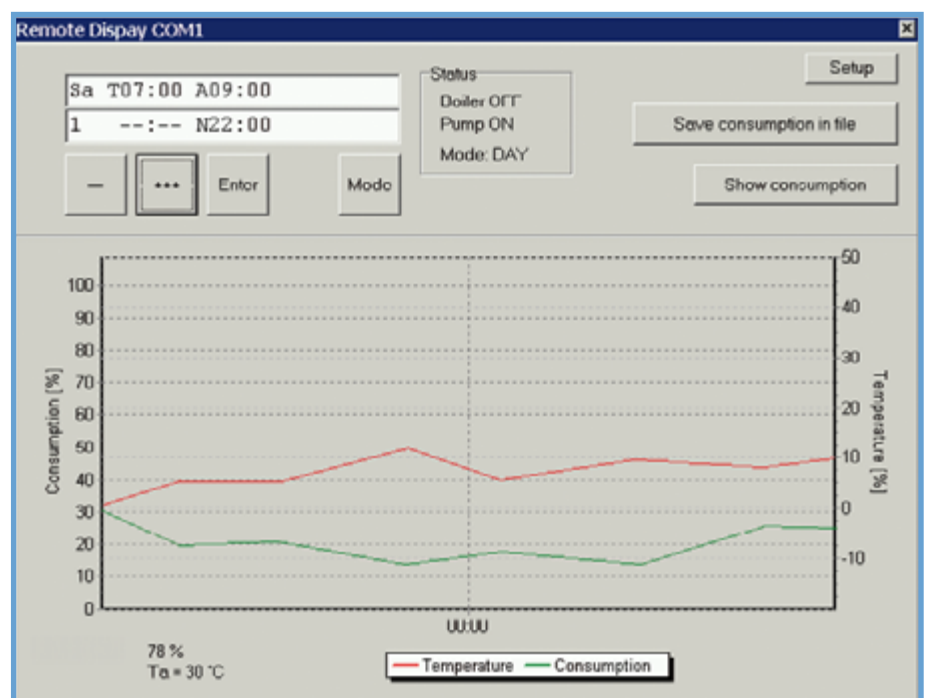

Figure 6. The remote control program running under Windows.



Handiwork

Tips & tricks for soldering & etching

Thijs Beckers

Without doubt the vast majority of our readers already know quite a bit about the subject of electronics. For the beginner however, there is much to be discovered, including the soldering of electronic parts. That's why we think there is absolutely nothing wrong to take a fresh look at the obstacles over which beginners often trip. But even if you do have a lot of experience already you may still pick up a few ideas from this article.

'The first step is the hardest.' This is a well known saying that definitely also applies to the world of electronics. If you've just started to take a peek, you run the risk of not being able to see the forest for the trees and throw in the towel prematurely. That is why in this article we give you a push in the right direction regarding some of the practical aspects of electronics, namely soldering and etching.

The first steps

Working with electronics requires a number of basic skills. The very first skill you need is to be able to distinguish the different parts, but we will assume here that this is not a problem for you any more. In addition it is 'handy' if you do not have two left hands and have a practical mentality.

To start with the practical part of soldering you will require, as a minimum, a soldering iron. A holder or stand for a hot soldering iron is very handy. A

soldering iron with a curved tip is very practical when soldering small components that are between other, larger components.

The tip and also the soldering iron must not be too big. For soldering SMD parts (Surface Mounted Device, a component that is soldered on the PCB and does not have connecting wires) a number of special soldering iron tips exist, as well as special small soldering irons. When working with SMD components a good pair of tweezers is almost indispensable. A magnifying glass can sometimes come in useful (when checking soldering joints on the PCB).

Of course, we also need solder (also see the text box 'lead free'). Choose the type that has the flux built in, that avoids the need to add the flux separately. Solder wick is very useful to remove excessive solder. This braid, made from thin copper wire, 'sucks-up' liquid solder like a sponge. When re-

moving large amounts of solder a desoldering pump is more appropriate.

These are the basic supplies that you need for soldering. Now you just need a printed circuit board and some parts and you can get started.

More luxury

Beside the standard soldering irons, there are also soldering stations available. These are usually more expensive, but also provide more control over the soldering iron. The station controls the temperature of the attached soldering iron to a set value. This is better for the soldering iron and easier to solder with. If the soldering iron is too hot then it is possible that the copper traces are lifted from the board, the tip oxidises faster, the flux goes up in smoke before it can get its job done, the component becomes too hot, etc, etc. A soldering iron that's too cold also has its disadvantages... With a soldering station you always know exactly what temperature you're working with.

Soldering stations are often also provided with a special earth connection. A special conducting wristband can be connected to this. This prevents static charges that could damage sensitive components on the operating table.

Complete workstations are also available that contain all sorts of bells and whistles: an ordinary soldering iron, a hot air blower, a desoldering iron with built-in vacuum pump and so forth. Especially if you work a lot with SMD parts, a hot air blower is almost indispensable. But for such a workstation you pay a considerable amount. If you only solder SMDs every once in a while then such a station is not necessary.

A number of different starter kits are available to get you started with soldering. Don't expect the best quality, but it can be a good choice when you're just starting out. The kit often contains all the basic necessities, including a circuit to solder together.

If you solder frequently you will appreciate a PCB work frame. This very handy aid simplifies soldering by holding the components in place with a foam cushion. You first place a number of components, close the 'lid' and then turn everything upside down. The cushion prevents the components from dropping out of the PCB

and this makes it very easy to solder the bottom.

Tips and tricks

Firstly, make sure you always have a clean soldering tip. You can use a wet sponge, special metal curls or tip-activator. Adjust for the correct temperature (about 370°C) and provide good lighting for the workbench.

If the soldering iron does not have a temperature regulator, the temperature can still be controlled to some extent using a small trick. By connecting a diode and a switch in series with the mains cord the soldering iron operates at half power when not in use. The switch can, for example, be built into the stand so that the iron only operates at full power when removed from the stand.

Various adapter-PCBs are available for experimenting with SMD parts. Different SMD-packages can be mounted on the small PCB that has a standard 2.54-mm grid for headers or other components. In this way a component that is only available in an SMD-package can be easily replaced without requiring a soldering iron.

A gas-powered soldering iron is very handy for soldering jobs in the field. In most cases these gas soldering irons can be refilled with the same gas that is used for cigarette lighters.

In addition to the gas option there is also the battery option. This operates with a special soldering tip. Both ends of the split tip need to be in contact with the object to be soldered. A large current will then flow, which heats the object in a few seconds to the melting point of solder. The tip itself hardly warms up while doing this.

When repairing circuits there will be the frequent requirement to desolder components. Special 'attachments' for soldering irons are available to desolder SMDs and ICs. These ensure that all connections are heated at the same time. With a special suction cup the components can then be removed relatively easily.

With freezer spray you can cool objects quickly. This can be useful when desoldering components. Once the component is free you can cool it quickly, which can reduce the risk of damage. Freezer spray can also be used to look for hairline cracks in PCB traces. Be-

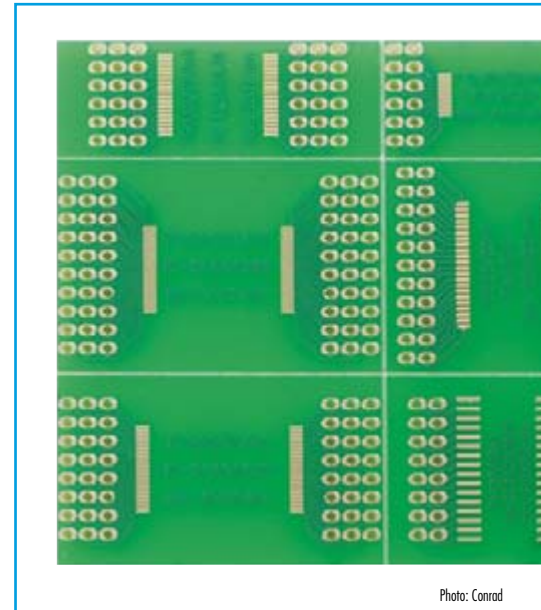

Photo: Conrad



Photo: Conrad



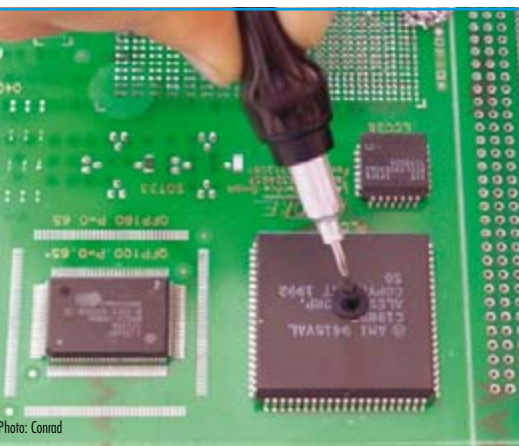

Photo: Conrad



Photo: Conrad



Photo: Conrad



Photo: Conrad

cause materials shrink when the temperature is lower, hairline cracks will become larger so that the connection is completely broken. This trick can also be used on electronic components. The internal connections that are potentially faulty will open when cooled and the suspect component will then be unmasked because of incorrect operation.

You can repair copper traces with a silver paint pen. This is very handy if you slip, when scratching a PCB (for example to fix an incorrect connection on a prototype) with a knife or scribe and accidentally cut something else as well. It is, in theory, possible to draw the entire schematic with a silver paint pen... Who is still using an etching tray?

You cannot use standard solder for the soldering of aluminium. For this you have to use special aluminium solder paste. This compound is such that the connection you want to make occurs at a molecular level, which results in a strong connection.

Instead of an anti-static bench mat you can also use an anti-static spray. To prevent the premature demise of sensitive ICs you apply an anti-static layer to the work surface. The spray leaves an ultra-thin invisible film behind that does not affect most types of plastic or rubber.

Printed circuit boards and such

Practically all electronic circuits are built on a printed circuit board. The printed circuit board consists of a special, non-conduction material, usually of the type 'FR4'. Printed circuit boards for certain projects (for example from *Elektor Electronics*) are often available ready-made. For your own PCB designs you can make you own. If you're not afraid of some chemicals and have a suitable work environment available to you, then you do not need to depend on special PCB manufacturers who supply prototype PCBs.

Here we give a brief description of possible problems, solutions and tips. When printing out the PCB layout on a laser printer there are sometimes thinly printed sections or holes can be seen when holding the sheet against the light. These holes often end up bigger when exposing the PCB because of the scattering of the light. This will result in defects in the PCB that can lead to a non-functioning circuit. There is a liquid available that can be sprayed on

the sheet. The toner then flows dense and there will be a uniform black print of the layout.

You can also use Indian ink. Wipe the sheet with ink and let it dry until it turns dull (15 to 30 minutes). Then with cold water and a soft wet tissue clean off the ink. The ink sticks better to the printed traces and stays there, which results in a nice black finish.

You can use ferric-chloride granules for the etching solution. This does not need to be heated, which results in fewer fumes. Because you can use it at room temperature you can get started right away. This chemical can be reused and is less aggressive than other etching solutions. However, it has a very strong colour, so watch your clothes.

Chemical tin is available to tin the copper traces. By submerging the PCB in this solution a uniform layer of tin is deposited on the copper traces. This tin protects the copper traces from oxidation. Plating with silver is also possible in a similar manner. Silver does oxidise, but silver-oxide is a conductor; copper-oxide is not.

To give a PCB, after it has been etched, that nice green finish, a green protective lacquer is available. This lacquer, in addition to the green colour, also protects against scratches and you can just solder through it.

Miscellaneous

Another tip: for drilling the holes in the PCB special hard-metal drills are available. These drills are not cheap however. Look for these on the electronic surplus markets, they can often be picked up for a song. They are second-hand from the industry, but are still very usable for hobby use. When drilling multi-layer boards, the manufacturer has to replace the drills more frequently. Even a small amount of wear can cause 'smearing', which can result in problems with the adhesion of the through-hole connections. So these drills still have a lot of life left in them.

You can use special front panel foil to put the finishing touch on your enclosure. With this foil it is very easy to give your project that professional look. The writable and laser printable foil can simply be stuck to the blank front panel. To protect the front panel a little extra, laminating foil can be very useful.

(060050-1)

Lead-free

According to new European laws, from 1 July 2006 no new electronic devices may be sold that have lead in them. However, these rules do not apply to hobbyists and for devices that are not sold on. The availability of products containing lead for the hobby market will reduce, since the largest market, the professional market that is, is not allowed to use these products any more. Nevertheless, this is not a disaster for the 'home worker'.

Lead-free products are also easy to work with. The soldering temperature has to increase however. While tin-lead solder melts at around 183°C, lead-free solder does not melt until 217°C or more. This means you have to be more careful to protect the electronic parts from excessive heat and potential damage. In practice it appears that the temperature of the soldering iron does not need to be increased.

Solder with lead generally consists of 60% tin and 40% lead. But there are several variations available that have other properties.

Lead-free solder is also available in several variations. A common variant is solder with 97.1% tin, 2.6% silver and 0.3% copper. This has a melting temperature of 217°C. Also common is the ratio 99.7% tin and 0.3% copper. The melting point for this variant is 227°C.



Quick checklist of soldering necessities

- ✓ soldering iron or soldering station including a stand
- ✓ solder (possibly both containing lead as well as lead-free)
- ✓ good work space illumination
- ✓ desoldering braid
- ✓ desoldering pump
- ✓ flux to aid the flow of solder (also when desoldering with braid)
- ✓ PCB holder or 'third hand'
- ✓ tweezers
- ✓ (side)cutters for cutting off protruding leads
- ✓ magnifying glass



Developing a Pro



Gert Baars

For the design of large electronic circuits you don't just need the necessary knowledge and experience. You also need good preparation and planning. Designer Gert Baars takes us through the design process for his shortwave receiver that's also published in last month's issue.

There is a lot involved in taking an original idea and turning it into a prototype. Several designers are often used in companies that develop prototypes. This lets each person concentrate on his/her specialist area, such as developing a concept, drawing up the specifications, designing the hardware or software,

testing and so on. This is usually very effective and also allows tight deadlines to be met.

Individual designers or hobbyists who have to develop a prototype on their own therefore have a long road ahead of them. As long as you keep your eye on the ball it is still possible to bring a complex project to a successful conclusion. It helps if you manage your time carefully, split the design into smaller tasks and complete them one at a time in a logical order.

Requirements and wishes

The first task in designing this shortwave receiver was the making of a type of wish list.

What specifications should it have and which functions should be included? There are many points that have to be considered. The complete design has to be feasible, practical and reproducible. The components shouldn't be too expensive and have to be easily obtainable. It is important that you have a good background knowledge as to which components are available. Reading trade journals and catalogues will help you discover new types of IC and other semi-conductors, which may possibly find their way into your next design.

At this stage of the design process you have to determine which

totype

from an idea to a working circuit

components are suitable for use in this project. These components sometimes have to be ordered from abroad, with delivery times that could be as much as a month. This is where you have to plan ahead carefully and make sure that you will have the components available when you need them.

Designing sub-circuits

With some further thought you can turn your list of requirements into a block diagram. This in turn can be used to create circuit diagrams for each of the blocks. In this instance you would need a thorough knowledge of RF design and be capable of predicting fairly accurately how a circuit will behave. Once most of the circuits have been put on paper, the foundation of the prototype will have been established.

For the design of some types of filter all you need to do is look up the right table and use a pocket calculator to calculate the component values. You do have to make an estimate beforehand as to what type and order of filter you require. Passive and active filters can be accurately simulated using simulation programs such as PSpice and Microcap. This makes it a lot easier to determine if a filter will suppress certain frequencies adequately and if its transfer function is as expected. At the same time you can also verify that the chosen component values are the right ones.

The pocket calculator is also essential for calculating the values of many other components, which requires a good knowledge of electronics theory. At the start you often have to collect a large amount of information regarding the operation of certain ICs and semi-conductors. The interpretation of this again requires a good grounding in electronics theory.

You will find the scientific calculator, which is bundled with Windows, to be a very useful tool since it can also perform calculations in binary.

The development of the project started with the design of the control sections. The program PCB-123 was used to design boards for the control and display. The layouts were printed onto transparencies and taken to a local electronics shop where they etched the boards for a nominal fee (you could also use a specialist PCB manufacturer, such as Eurocircuits). After drilling and populating the boards, and connecting them together, the first stage of the prototype was ready. The next logical step is the development of the software.

Software

When writing an assembly language program of more than a few hundred lines it is important for it to have a clear structure, as that makes it much easier to manage.

This requires that the program is divided logically into sub-routines, each of which should have clear comments with a short description of the routine and the variables and constants it uses. As the program grows you'll find yourself asking "how did that work again?" much more often. Clear comments after program lines are also invaluable when you have to familiarise yourself again with the operation of a piece of code when it seems it has slipped your mind. It often happens that you have to deviate slightly from your initial software design, which means that you have to make changes in various parts of the program.

When you're using Atmel's AVR's you'll find AVR Studio 3.56 to be a very good development platform. This program is available free of charge and has an editor, assembler and debugger. It can drive an STK-500 programmer directly to program the AVR's. You often won't need to use the debugger, but for routines with a large number of calculations it proves invaluable. Once a routine has been fully debugged and you know that it doesn't contain any errors, you can add the word 'TESTED' to its header. This is very useful during faultfinding, since it reminds you that this routine works flawlessly and you should look elsewhere for the problem.

Eventually you reach a stage where the software works roughly as intended and you can concentrate on the hardware, such as the VFO, built using the DDS IC.

Sub-circuits

With the help of the circuit diagrams you'll be able to construct some of the sub-circuits. These will then have to be individually tested. Sometimes you can do this with the appropriate test equipment, but more often you can get a better impression of how a sub-circuit functions if you add it to the prototype. Once in place, you can always take some measurements as well. Sometimes you'll find that you need to modify a circuit. It can just be a different value for a resistor, but sometimes you'll realise during this process that a circuit may be implemented better in a totally different way, for example through the use of a different IC.

The operation of sub-circuits will often be close enough to the predictions and calculations made beforehand (although this is obviously only the case if you have the required experience). The process of building, testing and adding sub-circuits to the prototype will see it grow towards its final design. Eventually the prototype is just about complete. All of its functions are operational and all tests completed satisfactorily. To get a good idea of the circuit operation, we should (in this particular case) try out the RF receiver. It's sometimes only when you've used a circuit many times that you'll notice certain shortcomings. For this receiver it was found that the volume level for some powerful SW stations was much too quiet. It turned out that the signal was so strong that it started clipping on the supply rails. In the end it was found that a secondary AGC circuit provided the best solution.

In this way all the shortcomings that were initially overlooked were found, and appropriate improvements were made to the prototype. The same applied to the software, where several changes were made because they weren't thought of initially.

Instructive experience

All in all, a lot of preparation and research is required in the design of a circuit that has 14 ICs, not counting the voltage regulators. Just writing the software and debugging it took several weeks. Even so, it gives you a lot of satisfaction when it finally comes together and it all works as intended. The development of such a project is often also an instructive experience. The experience gained comes in useful when the time comes for the next project.

(065105-1)

Hydra Game Development

Design your own computer games for



Luc Lemmens

This month we discuss an entirely different type of development kit compared to what we are 'normally' accustomed to. Most kits consist of a processor board with a bit of I/O, LEDs, displays, etc., that a designer can use to gain experience with a certain type of processor by working through a few (simple) examples. With the Hydra kit the objective is completely different, namely learning the development of computer games.

The design and composition of the Hydra kit is therefore very different from the average development system. The multi-tasking capabilities of the Propeller chip from Parallax are eminently suitable for a computer game.

Computer games comprise many tasks that have to be carried out simultaneously, such as the reproduction of video and audio, calculations, search algorithms, etc. The Propeller contains eight 32-bit processor cores which can work simultaneously and is therefore made for this type of application.

For those among us who have worked with 'classical' microcontrollers up to now, the Propeller will require a different way of thinking because the internal structure is very different from what we are used to.

Documentation

The thing that immediately stands out when you open the box containing the Hydra kit is the 800-page manual: a real book! This is quite unusual these days, but Parallax obviously considers it important to provide a printed manual with their products. With development kits from other vendors you often are faced with a laborious search for manuals on the included CDs and it is not always clear where you have to start. Not everyone (understatement?) is likely to print documents of this size and read them thoroughly first. However, this is exactly what this book recommends: read first and then get stuck into it. But don't let that discourage you, the manual progresses at a rapid pace and contains, in addition to the theory, also nice 'excursions' such as a chapter about the highlights of the

Development Kit for the Propeller chip

history of hard- and software for game computers. The entire book is also on the CD that comes with the kit. On this disc we also find the development software, numerous programming examples and many extras among which the e-book 'The Black Art of 3D Game Programming' stands out. About ten years ago this book was the 'bible' for games programmers and still contains much useful material and background information. The manual leads us past the architecture of the Propeller chip, the programming language Spin (specifically developed for this processor) and the assembly language for this processor to our ultimate goal: the development of computer games. This part occupies about half of the book and deals, after a short introduction, with subjects such as graphics, processing of input, sound, animation, artificial intelligence, physics modelling, in summary: everything that is relevant when programming computer games.

The Hydra processor board

The Propeller is the heart of the Hydra-system, but a processor by itself does not make a game computer of course. That is why it is expanded with a number of interfaces and options (see sidebar), most of which will be familiar so there is no need to explain those further. They are all described in detail in the book, but we will explain a little more about the less familiar ones.

The debug indicator is nothing more than an LED that can be used during debugging, for example as a sign that a certain program loop has completed. A little primitive and old-fashioned method of debugging, but unfortunately the current development environment for the Propeller does not (yet) support any other method of debugging. This is nonetheless sufficient in many cases to enable progress to be made when there are problems in the software. The LED is driven via a port pin on the processor and the user can turn this on or off at any desired location in the application. The expansion port for the game cartridge and EEPROM is a standard 20-way, 0.1-inch card edge connector that contains most of the signals for connecting external hardware. On this connector you'll find power supply voltages, eight I/O lines, Hydra Net (see later on), reset, I²C and serial connections. In addition, feedback from the power supply voltages signals the presence of external hardware to the processor. The Hydra kit contains a blank cartridge board so you can build your own hardware and a small PCB with a 128-kB EEPROM plus a small prototyping area.

The Hydra Net connection is intended to let two Hydras communicate with each other via a simple and cheap serial connection. A standard 4-core telephone cable with RJ-11 connectors was selected to enable a cheap but still reliable connection to be made.

Peripherals

The game development kit contains, in addition to all the cables, also a mouse, keyboard and game pad and

Features

- USB-programming-interface
- Debug indicator
- Connections for two game-controllers (NES game pad)
- Composite-video-output (PAL/NTSC)
- VGA-output
- Mono audio-output
- PS2 keyboard- and mouse connections
- Game-cartridge, EEPROM and expansion port
- Serial network connection
- Development-software for Windows 2000 and XP

a (North American!) mains adapter. Importers such as Milbrook Instruments (for the UK) may supply a converter for connection to the local mains. Reasonably complete, so that you can get started immediately, but – as already mentioned – the book recommends that you read it first before connecting anything. Good advice that is disregarded all too frequently. Some experience with a higher programming language and assembler is certainly recommended.

Development software

The development environment that comes with the kit has been specifically designed by Parallax for the Propeller chip and works under Windows 2000, XP and Vista. This software is very simple to install and use. The Spin programming language looks like a mix of Pascal, Basic and assembly language and is reasonably straightforward to become familiar with.

An application for the Propeller can consist of modules that are written in Spin and modules that are written in assembler. The assembly language will require a bit of practice, but runs many times faster than Spin, which is certainly very important for time-critical processes (such as video-output, for example). In order to make lightning-fast games you will not be able to ignore assembly programming and you will have to get past the sour taste; on the other hand, some will feast on it! Nevertheless, assembler is not covered all that well in the book, it receives very little attention. But other documentation on the CD and on the Parallax website provides more clarification for those who are interested. Note that the development software is a free download, so you can use that too if you would like to find out a little more about the Propeller first.

Conclusion

The Hydra Game Development Kit is a very complete package for the development of software and – naturally – computer games in particular. The hardware is, with respect to memory size, somewhat limited and therefore do not expect to be able to develop a 'state-of-the-art' PC game or a console game. But it is eminently suitable to learn the underlying techniques that play a role in this type of application.

From the peripherals the only thing that's really missing is the monitor, but any standard VGA monitor or a TV with composite video input will work well here. Everything considered, this kit is certainly worth the purchase price of £ 165 (€ 180; US\$ 199.95)!

(070241-1)

Web Links

www.parallax.com
www.milinst.com

E-blocks Tacho

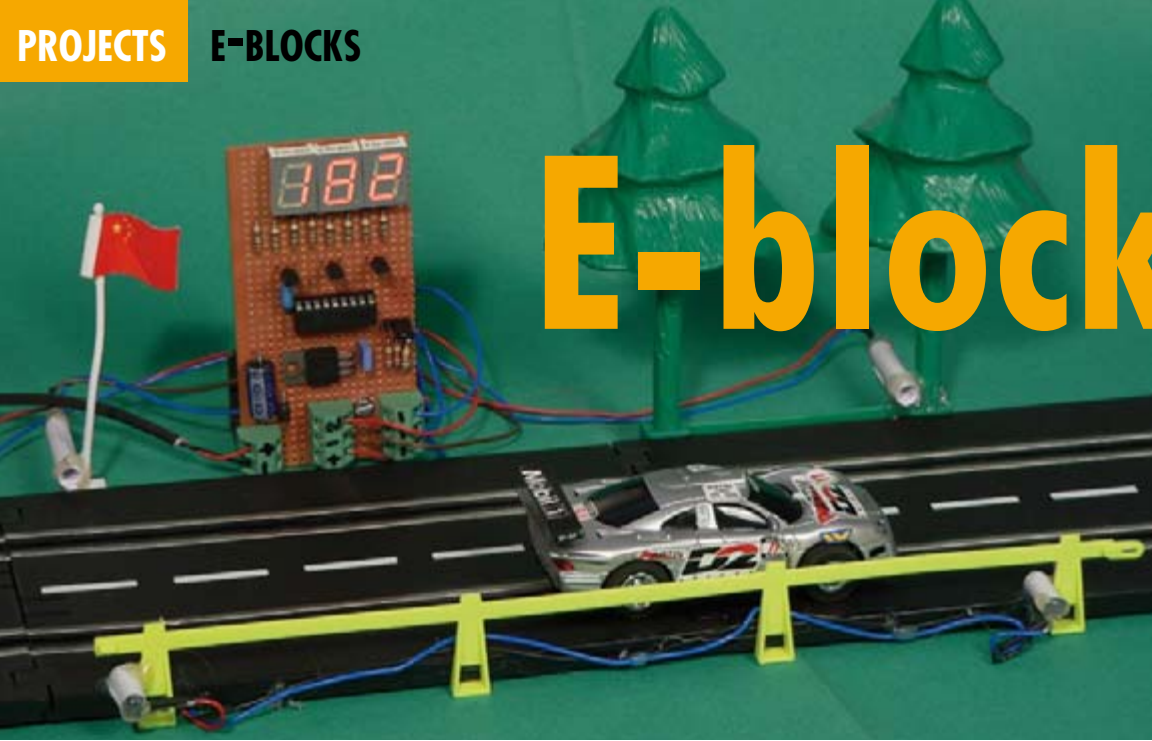

Jean-Paul Brodier

The timer measures the time between two events: the crossing of two photoelectric barriers. As the distance between these barriers is known, a simple 'rule of three' will give us the speed of the moving object that crosses the barriers and hey presto our timer becomes a tachometer.

Hardware

The hardware comprises, as usual, a PIC16F88 microcontroller, in the small

18-pin version. Input-wise, the detectors are two phototransistors, which can be any type – these are normally turned on by the light from infrared LEDs. On the output side, we have a three- or four-digit 7-segment LED display. The detectors are connected to PORT A on the microcontroller, either via connector J2 of the Multi-programmer board, or via the terminals on the self-contained board. The two emitters are connected in series and permanently powered.

Powering

For testing and setting up, the Multi-programmer board and the four-display board are powered from the mains power supply; the barrier LEDs are supplied from the Multi-programmer board's 5 V output.

For the self-contained board, a small 9–12 V mains supply unit of almost any type can be used, or else the 12 V from the car supply transformer, after cutting the wires to insert a socket or screw terminals. The voltage is re-

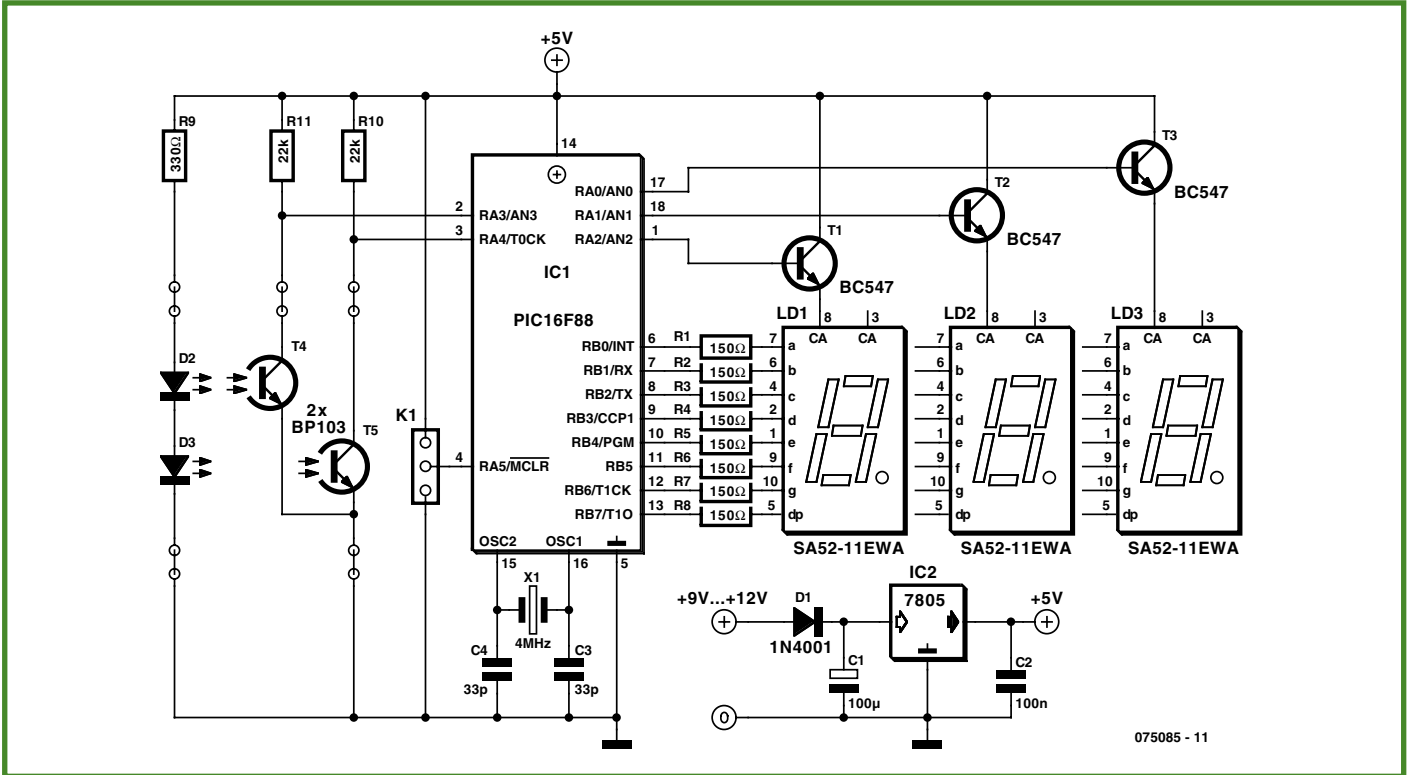

Figure 1. Circuit diagram of the self-contained tacho/timer. The segments and anodes are connected to the pins of ports B and A in the same order as for the E-blocks Four-Display board.

homemeter/Timer

Speed = distance / time

After having looked at Flowcourse in the previous article by the same author (June 2007), this month we're taking up our soldering irons again to suggest a small project that will serve as an application – a tachometer/timer. As before, the Flowcode files for this are on the Elektor website.

duced to 5 V by the regulator on the self-contained board.

Display multiplexing

A digit is displayed by controlling the seven LEDs or segments forming the display. Hence it would take 21 output lines to control our three digits. As we don't have enough output pins for that, we're going to have to rely on the process known as 'multiplexing', as used in the 'Matrix LED sequencer' in the April

2007 issue. Each display will be enabled (by powering the anodes of the LEDs) for only a part of the time. While the anode of one digit is powered, the segment cathodes of all the digits in parallel are fed with the voltages corresponding to the state of the segments for this digit. But only the segments of the digit whose anode is powered will actually light up. Then it's the turn of the next digit: the program sends the states corresponding to the figure to be displayed to the PORT B outputs,

and the corresponding state of the anode to be enabled to the PORT A lines. All this happens fast enough that our eyes perceive the three digits as lit at the same time, each with the correct segments.

The anodes are powered by the NPN transistors, arranged as emitter followers. The E-blocks board includes protection resistors in series with the bases of the transistors, and pulldown resistors in case the bases should ever be left floating. On the permanently-

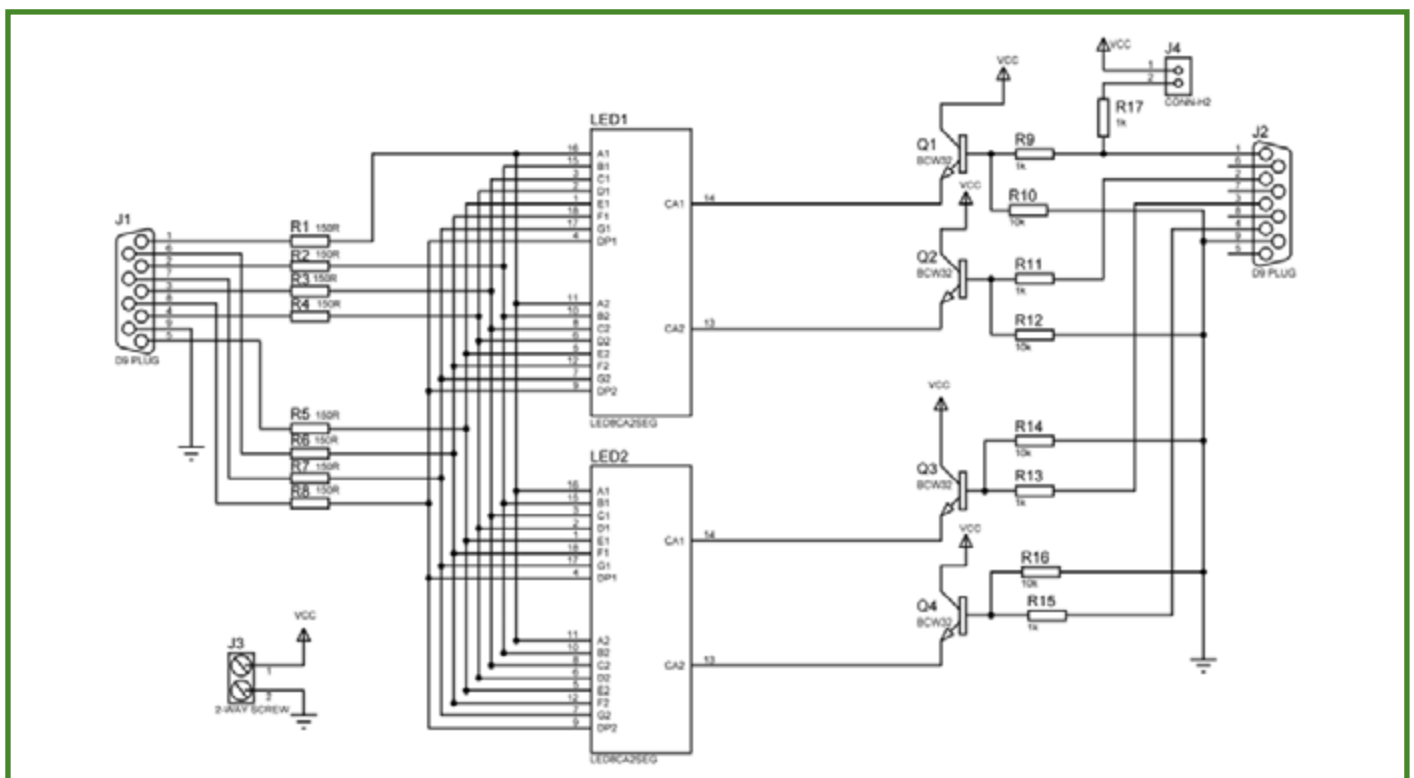

Figure 2. Circuit of the E-Blocks four 7-segment display board (source: Matrix Multimedia).

Listing 1.

The interrupt routine hiding behind the label 'Multiplexing'.

```

/*Enter C code after these comments */
FCV_RANG = FCV_RANG + 1;
FCV_RANG = FCV_RANG % 3;
^
switch(FCV_RANG)
{
case 0 : FCV_NUMBER = FCV_ONES; FCV_ANODES = 1; break;
case 1 : FCV_NUMBER = FCV_TENS; FCV_ANODES = 2; break;
case 2 : FCV_NUMBER = FCV_HUNDREDS; FCV_ANODES = 4; break;
}

switch(FCV_ NUMBER)
{
case 0 : FCV_SEGMENTS = 0x3F; /* 0111111 */ break;
case 1 : FCV_SEGMENTS = 0x06; /* 0000110 */ break;
case 2 : FCV_SEGMENTS = 0x5B; /* 1011011 */ break;
case 3 : FCV_SEGMENTS = 0x4F; /* 1001111 */ break;
case 4 : FCV_SEGMENTS = 0x66; /* 1100110 */ break;
case 5 : FCV_SEGMENTS = 0x6D; /* 1101101 */ break;
case 6 : FCV_SEGMENTS = 0x7C; /* 1111100 */ break;
case 7 : FCV_SEGMENTS = 0x07; /* 0000111 */ break;
case 8 : FCV_SEGMENTS = 0x7F; /* 1111111 */ break;
case 9 : FCV_SEGMENTS = 0x67; /* 1100111 */ break;
}
FCV_SEGMENTS = ~FCV_SEGMENTS;

```

wired self-contained board such precautions are unnecessary, and these resistors are omitted.

We're only going to be concerned here with three displays: either the ones on the self-contained board built for this application (**Figure 1**), or the three right-hand digits only of the four on the E-Blocks 7-SEGMENT LED BOARD (EB-008-00-1), the circuit of which is given in **Figure 2**.

Just as for the light sequencer, an interrupt routine is used to drive the displays. This interrupt is triggered when TIMER0 overflows. The routine then reads the figure to be displayed, looks up the corresponding segment combination in a table, sends this to the PORT B output pins, and enables the anode output. The three figures to be displayed are stored in the variables ONES, TWELVES, and HUNDREDS; these values represent the result of the calculations written by the main program.

Declaration of the variables

The variables are declared during initialization at the start of the program. All the variables are global, i.e. visible

in all parts of the program. The time and speed are set to zero, the figures to be displayed take the value 8, which acts as a display test.

The interrupt routine hiding behind the label 'Multiplexing' comprises a section written in C, in the macro 'Multiplex' (see **Listing 1**).

The binary values represent the lit display segments from a–g, starting from the right. To physically light them, the corresponding output needs to be taken 'low', whence the bit complementing in the SEGMENT variable, using the tilde operator (~). Flowcode understands binary numbers, but the C compiler doesn't, hence the need for the expressions in hexadecimal.

The decimal point is connected but not used in this application: the MSB is always zero.

Photo-electric barriers

Each barrier consists of a light emitter and a receiver. The wavelength of the light lies in the infrared, but it might equally well be visible – it just happens that IR phototransistors are the most common and easiest to get hold of. The connections are as per the cir-

cuit in **Figure 1**. Each component is glued inside a small tube 2–3 cm long, which concentrates the light on the emitter side and blocks stray light on the receiver side. You have a choice between the brass tubing used in modelling or tubes of paper rolled round the shank of a 5 mm drill bit, held with a dab of paste. These tubes should be glued onto scenery items either side of the track. The two elements of each barrier should be positioned near track level and aligned as accurately as possible. The components should be connected to the self-contained tachometer board using thin wire.

Scanning the inputs

Crossing the light barriers is detected via the change in state of the PORT A inputs: when the phototransistor can no longer 'see' the light from the LED, the corresponding input goes high. This is the event waited for in the entry wait loop during the measurement interval (first barrier, pin 2 RA3) and the exit wait loop (second barrier, pin 3 RA4).

Measuring the time

The time is measured by a loop counter. When the first barrier's beam is broken, the counter TIME is reset to zero and the loop increments it by one each time round. The count stops when the loop detects the second barrier's beam has been interrupted.

During the timing period, the TIMER0 interrupts risk distorting the count. This is why the first operation, before going into the loop, consists of stopping the multiplexing: disabling the interrupts and the display anodes. The displays go out, which avoids leaving one of them permanently lit.

Displaying the time

Coming out of the loop, the number of times is stored in the TIME variable. If pin 4, RA5, of PORT A is 'high', this is the number that will appear on the three LED displays.

The function of pin RA5 (MCLR) is set by configuration, accessible using Puce, Configurer, PICmicro Configuration (expert).

Each loop represents 39 μ s, so all we have to do is some multiplication to obtain the time. This option is helpful when getting the program working.

During normal use, pin RA5 will be kept Low, so as to display the speed.

Calculating the speed

The distance covered is the spacing between the two barriers. In the test set-up, this is 24 cm. The speed could be expressed in cm/s, but that doesn't mean very much. We're going to perform a number of arithmetic operations so as to display a speed in km/h. For the distance, we apply a 'rule of three' to get the distance covered in an hour: distance / time in seconds \times 3,600.

Scaling factor

We now know the distance actually covered in one hour by the scale model – but this is hardly impressive! So we multiply this distance by the scale of the models – here 1/32 – to obtain a projection of the speed at full scale.

Displaying the figures

The arithmetic operations are performed after the end-of-timing wait loop. The hex number is converted into decimal figures, which are loaded into the variables ONES, TENS, and HUNDREDS, where the interrupt routine is going to read them.

The figures displayed are made up of seven segments, identified as a–g. For each figure from 0–9, the combination of segments lit is stored in a set of bytes in the memory; this is what we call a character table. To display the figure *n*, the interrupt routine loads byte *n* from the table and copies it to PORT B.

Problems of logic?

The light barriers cross both lanes of the track, so there's nothing to stop two cars being in the measuring zone at the same time. Does this pose a problem? In theory, no. If the second car enters the zone before the first has left it, its entry is not detected, as the program is in the exit wait loop. If the second car enters just after the first has exited, the display will be too short for us to read the speed of the first car, but the speed of the last car to exit will be displayed correctly.

When the tacho/timer first starts, the TIME variable is left in a random state, which could quite well be zero.

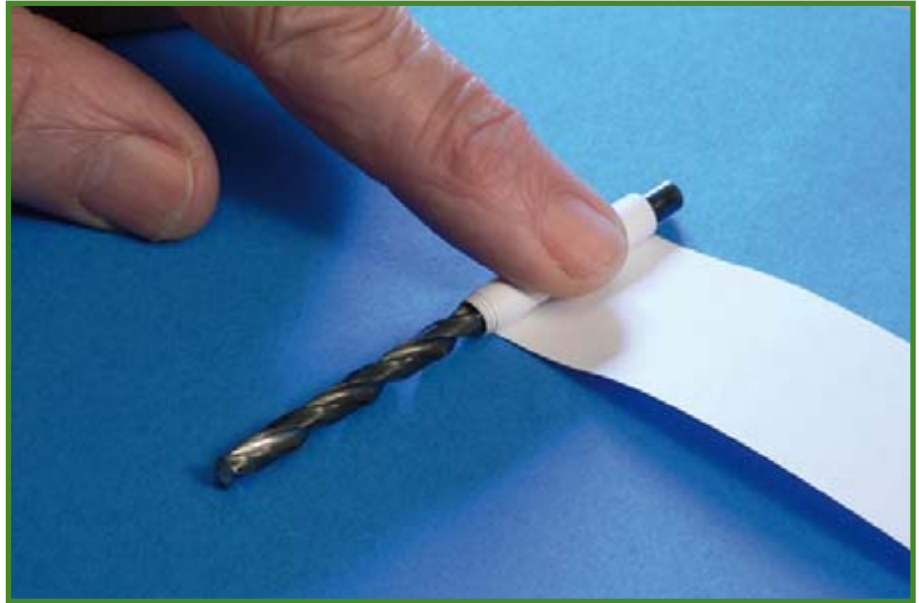

Figure 3. Shielding tube for the phototransistors: a strip of paper rolled round the shank of a 5 mm drill bit, held with a dab of paste.

To avoid division by zero in the calculation (if the divisor is zero, the speed calculation routine won't run), the display indicates '888'. It will only adopt a meaningful value once a measurement cycle has been performed.

(075085-1)



Figure 4. One of the mounted phototransistors (at least one lead of which needs to be insulated) in position, held with a few spots of hot-melt glue.

Rapid Manufacturing for Electronics Enclosures

SLS technology makes any shape possible

Wisse Hettinga

Everybody who is active in electronics comes across this problem: you've created a great circuit, it works well, but where do I leave the electronics? Leaving it on the desk is unsightly. It can attract dust, condensation, other dirt and the PCB or components could simply become damaged.

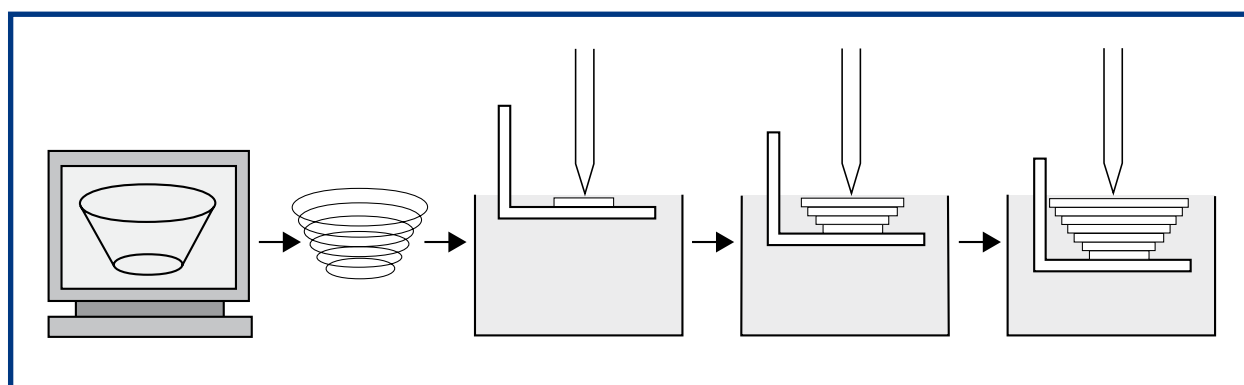

Figure 1.
The RM process, where the product is created layer by layer.

In many cases the designer will choose a standard enclosure made of plastic or aluminium. But often this won't be ideal. The case can be too large, too small, made of the wrong material, become too hot, can't withstand the cold, the list is endless. How can this be avoided?

To get round this problem, designs often take an existing enclosure as the basis for the design. We also do this at Elektor. We know exactly where the mounting holes in the PCB should be and where the exit holes for cables are. But let's be honest, a standard box will always look like a standard box.

Elektor recently came into contact with TNO, a technology & research institute in Eindhoven, The Netherlands, who just happened to be evaluating a new technology to create enclosures to order and in any imaginable shape. This technology is called 'Rapid Manufacturing using Selective Laser Sintering'. With this, a model is designed in a 3D CAD application, and then created layer by layer using powdered nylon. A laser beam heats up a thin layer of nylon powder, which makes it adhere to the previous layer, and so on (**Figure 1**). In this way products can be made layer by layer and there is (almost) no limit to the shape that can be created.

Any shape imaginable

We normally think of an enclosure as being defined by its length, width and height, but with this technology it's completely different. Imagine enclosures in the shape of a globe, or a type of wristband with built-in electronics, or perhaps an oval shape or circular? When you leave the material thinner in places the light from an LED can shine through and the addition of a switch and other mechanical additions will further enhance the design. Small cogs and transmissions are also possible.

Everything is possible. To try out this process, Elektor asked Rein van der Mast, industrial designer, to design an enclosure for the Software Defined Radio, a project from the April 2007 issue of *Elektor*. He took inspiration from the *Elektor* logo and radio waves circling the Earth. The result is an impressive enclosure with the e from *Elektor* on the radio waves across the world, and all made to measure (**Photo 1**).

Custom made or standard

But according to Henk Buining, project leader at the TNO, there is also a clear market for something in between: half custom made, half of the shelf, and where there's a market there's a project! The project at TNO is clearly aimed at the electronics engineer who wants a



Photo 1.
A good project deserves a good enclosure, in this case the box for the Software Defined Radio.

standard type of enclosure, but with specific dimensions and specifications. For this target group a portal is being developed where the main dimensions of the enclosure can be entered (length, width, height) and where the cable entry holes or ventilation slots should be. The result is a neat nylon enclosure, exactly to the specifications of the client (**Photo 2**).

Costs

The key question is of course: what will all of this cost? Perhaps this should be answered with another question: what is it worth to you to have your project housed in a good-looking enclosure? A made-to-measure enclosure with a special shape is obviously more expensive than a standard box. For individuals it can be a great way to

finish their project, for inventors and designers it's a good way to find out if their design is functional, and for companies it provides an opportunity to show their clients a 3D model of their design.

(070720-1)

Information

We can imagine that some designers and constructors would like to find out more about this technology, its potential and costs. Either contact Elektor or for more information about the TNO Rapid Manufacturing Demo Centre, take a look at <http://www.tno.nl/?Taal=2>



Photo 2.
Half custom made, half standard. These enclosures have standard shapes (rectangular, square), but all dimensions and holes can be specified by the client.



componentbin.com

Online Store!

Our online store contains an ever expanding variety of products designed for engineers, hobbyists and students. These include:

- ARM Development Systems
- Ethernet Modules
- RF Modules
- Graphic LCD Displays (With example software!)
- Home Automation
- Power Conversion
- Components & Connectors
- And Much More!
- Educational Discounts Available

Full product support with reference software and secure online ordering to kickstart your development.

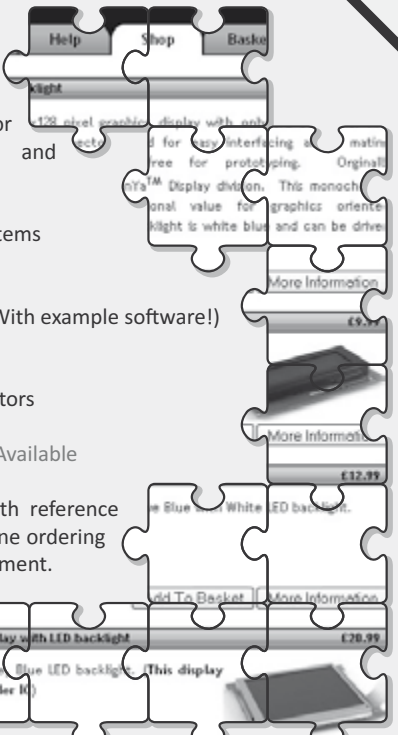

www.componentbin.com
+44 (0) 1354 778224



EzPCB
Professional PCB Supplier

High Quality
Competitive Price

URL: www.EzPCB.com
Email: sales@ezpcb.com Tel: +86 139 1002 1704
HDI Up To 50 Layers, 2.5mil T/C, 0.1mm Hole Size
Other Products: Stencils, Keypads, Frontpanels, Flex PCB, Enclosures, Turnkey Services



Take out a free subscription to E-weekly now

Do you want to stay up to date with electronics and computer technology? Always looking for useful hints, tips and interesting offers? Subscribe now to E-weekly, the free Elektor Newsletter.

Your benefits:

- The latest news on electronics in your own mailbox each friday
- Free access to the News Archive on the Elektor website
- You're authorized to post replies and new topics in our forum



Register today on www.elektor.com/newsletter

MJComponents.com
Suppliers to the hobbyist and trade
Specialists in High Power LED's

Our range includes:

- **LED's**
High Power LED's from 6p each - various colours
- **Components**
Resistors from 17p for 10
Electrolytic capacitors from 2p each
Motors
- **Batteries**
AA Batteries (Rechargeable) from 83p each
AA Cells (Disposable) from 13p each
Coin Cells, C, D, PP3, Lead Acid etc
Various chargers
- **Tools**
Multimeters from £4.25
Various handtools
- **Anti Static packaging**
Full range of bags available.
- **Plus a range of electronics related books**
Trade enquiries welcome

Full on-line shop at www.mjcomponents.com
webinfo@mjcomponents.com
(Prices exclude VAT @ 17.50%)



How many pieces of test equipment can you buy for £99?

With a PoScope USB instrument you get the features of an oscilloscope, spectrum analyser, chart recorder, logic analyser (with UART, SPI, I²C and 1-wire serial bus decoding), pattern generator and square-wave/PWM generator. That's equivalent to six pieces of test equipment for £99 including UK delivery and VAT.

PoScope is a low-cost USB-based instrument that adds invaluable test equipment features to your desktop or notebook PC. Being PC-based, all measurements can be printed, copied to the clipboard and saved as text, bitmap or vector graphics for subsequent analysis or to import into other programs. PoScope is ideal for use by electronics hobbyists, students and engineers alike and is particularly suited to those developing with microcontrollers such as PIC and AVR.

PoScope provides the following operation modes:

- 2-channel oscilloscope with 100Hz to 200kHz sampling, -20V to +20V input range, 10-bit ADC resolution, absolute, differential and external triggering, adjustable pre-trigger and marker measurements.
- 2-channel spectrum analyser with klirr factor measurement, Hamming, Hanning, Blackman and Blackman-Harris FFT window functions.
- 2-channel chart recorder with 0.01Hz to 200kHz sampling, maximum, minimum and average voltage measurements for each channel and waveform record over several tens of hours.
- 16-channel (8 when pattern generator used) logic analyser with 1kHz to 8MHz sampling, versatile triggering with adjustable pre-trigger, external clocking, preset pulse miss, preset bit sequence/edge, decoding of UART, SPI, I²C and 1-wire serial interfaces.
- 8-channel 1kHz to 1MHz pattern generator with tabular waveform formatting or direct timing chart plotting on the screen.
- Square-wave/PWM (pulse width modulation) generator.

Compatible with Microsoft Windows ME, 2000 and XP, PoScope is supplied with easy-to-use software and a USB cable. Oscilloscope probes and logic analyser test lead/clip sets are available separately.

Order now on **Freefone 0800 612 2135** or online at www.paltronix.com

PALTRONIX
EQUIPMENT FOR ELECTRONICS DEVELOPMENT, TRAINING & EXPERIMENTATION

Paltronix Limited
Unit 3 Dolphin Lane, 35 High Street, Southampton SO14 2DF
Telephone: 0845 226 9451 Facsimile: 0845 226 9452
Email: sales@paltronix.com Web: www.paltronix.com



All major credit and debit cards accepted

Mesmerising Images

Jeroen Domburg

Most people know of the visualisations in Winamp, Windows Media Player, XMMS and similar programs. They show hypnotising and colourful effects that react to the music. There's one disadvantage: they only work on a computer. This is something we're about to change! Using a powerful ARM chip and an old GSM display, in this article we'll be making a standalone version. With the right 'plug-in' it can also function as a real-time spectrum analyser.

Everybody will have come across them, the dancing images on the computer display, created by plug-ins in audio players. They take the audio data from the playing audio file (often an mp3), analyse it with for example a Fast Fourier Transform (FFT) and process the result in particle systems and numerous other algorithms, which have one purpose in mind: create the most hypnotic display possible. This 'standalone audio visualisation unit' was developed to have something to look at without requiring a PC.

Requirements

To generate such an audio visualisation we need several things, which are an audio source, a device that can perform real-time analysis algorithms and a display. For portable use, a microphone is used as the audio source. And a small

colour display, from for example a Nokia 3510i, will reduce our costs, since these GSM displays can often be bought for peanuts or removed from a non-working mobile (make sure that it is a 3510i version, as the Nokia 3510 without the 'i' has a monochrome display).

That just leaves the audio analysis. Most of the time a DSP (Digital Signal Processor) is used for this. This has been specially designed for the fast processing of signals. The disadvantage is that these chips are fairly expensive and not always easily obtainable. A good alternative is the LPC2100 ARM processor family made by Philips. The LPC2103 is especially appealing for this project: it is a 32-bit processor with a maximum clock frequency of 70 MHz. An A/D converter and an SPI interface are embedded on the chip. And these are just what we need for this project. The 32K Flash memo-

ry can be programmed via the serial port, so there is no need for a special programmer.

There is only one disadvantage with this chip: it is only available in a TQFP-48 package, which means that the connections are about half a millimetre apart. To use this small chip it is necessary to mount it onto a PCB. This can be achieved in one of two ways. The first is to use a special adapter board for TQFP-48 ICs. All pins are brought out as holes arranged in a standard DIL format. However, these boards are fairly expensive and, compared with the display, quite large.

The second option is to design and etch our own board. As can be seen from the inset, it doesn't have to be expensive or difficult. A free program called 'PCB' was used to create a board layout, which can be downloaded including the Gerber and Postscript files

Making and soldering the PCB

Although some readers will be able to convert the layout for the board into shiny copper tracks without any problems, others may be put off by the pad separation and the pins on the LPC2103. However, constructing this board isn't as difficult as it seems and it doesn't need to cost much either.

Requirements:

- ✓ Photo paper. For example HP High Gloss.
- ✓ A monochrome laser printer
- ✓ A blank PCB, i.e. with bare copper cladding.
- ✓ Etchant. For example sodium persulphate.
- ✓ A plastic tray, big enough for the PCB.
- ✓ An iron at its hottest setting.

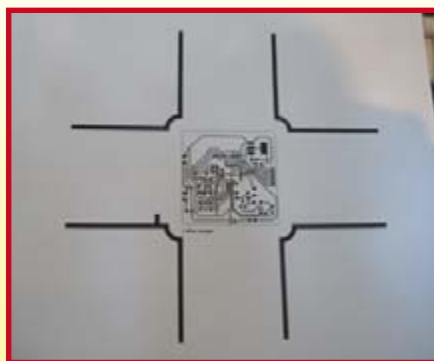

Instructions:

Take the photo paper and print a mirror image of the layout. Never touch the copper cladding of the board (always hold it at the sides). Fingerprints and smudges are likely to cause the etching to fail. Next put the photo paper with

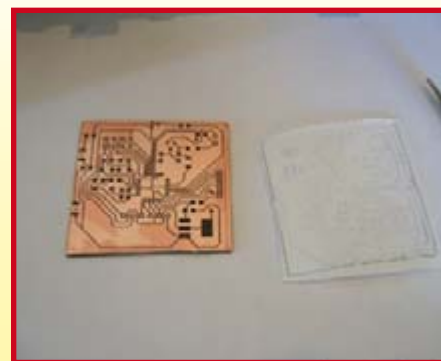

the printed side onto the copper side of the board and carefully iron the paper. The intention is that the heat will cause the toner to detach itself from the photo paper and transfer to the copper. The toner is now on the copper cladding and the uncovered copper should be etched away. Although a proper etch tray is quicker, for small

Audio analysis on a GSM display

([1] and [2]). The board is double-sided, although one side can be replaced with wire links.

Hardware...

Since most of the hardware is already inside the microcontroller, the rest can be made very compact. We only need to add a microphone pre-amplifier, a reset circuit, a crystal and two supply voltages (see **Figure 1**). The LPC2103 requires two supplies: 3.3 V for the inputs and outputs, and 1.8 V for the ARM core. For the first supply a standard part is used: an LM1117MP-3V3. For the 1.8 V supply we've added two diodes in series with the 3.3V supply. This gives us 1.9 V, which is a little bit too much, but this isn't a problem. In the notes of the microprocessor data sheet it states that in some cases a voltage slightly above 1.8 V can even provide a better stability.

The microphone pre-amplifier is a simple one-transistor affair. HiFi aficionados are likely to throw up their arms in horror by the distortion and temperature sensitivity of this simple circuit, but we only use the input for generating displays, where the distortion has a negligible effect.

The electret microphone requires a supply voltage to operate, which is provided via R6. C7 filters this out again and passes the signals from the micro-

phone on to T2. The R7/R8 network sets the gain. R7 is used for biasing the transistor as well as providing feedback, and R8 limits the current through the transistor. C8 passes on the amplified signal to a pin on the microcontroller, which is connected to the internal A/D converter.

D1 and D2 are white LEDs that provide a backlight for the LCD. The microcontroller can dim or turn off these LEDs via T1. The LEDs have to be mounted in such a way that they illuminate the underside of the LCD. For the display from the Nokia 3510 you will need to drill two holes through which the LEDs can fit.

X1 generates the clock signal for the microcontroller. As this crystal is 'only' a 20 MHz version, the signal is multiplexed by an internal PLL to an impressive 60 MHz.

R5 and C9 form an R/C network that momentarily pulls the reset input of the processor low when the supply is turned on. The LCD is connected to the SPI output of the controller and only requires a 3.3 V supply and an external capacitor (C10) to function.

There are also a few pins brought out for connecting to the outside world. These are used for programming the controller via the serial port of a computer. Keep in mind that these pins oper-

ate at 3.3 V. You will therefore need a level shifter such as a MAX3232. An old, normal mobile phone data cable should also work.

...and software

The hardware is only half the story though. At least as much work has gone into the firmware for this project. After all, the difficult task of processing the signals happens here.

In contrast with some other microcontrollers, the ARM has been supported from the very start by the open-source C compiler GCC. Due to the orthogonal architecture of the ARM this compiler can generate very fast code. Apart from that, the algorithms used are a bit too complex to implement in assembly language in a reasonable amount of time. This was the main reason for writing virtually all of the firmware in C. In this way it is also easier for you to add other visualisation routines to the code.

The code consists of three main modules: the audio input and processing routines, the effects generators and



boards like this any small plastic tray will also work. Pour some warm water (60 degrees) and add the etchant according to the instructions on the packaging. It is best if you wear some old clothes since the etchant causes nasty bleaching that can't be removed. Also make sure that you're in a well-ventilated area when you do the



etching. When the etchant turns blue you know that it's working: this is the colour of the dissolved copper. It helps if you continuously stir the liquid, but be careful of any splashes. A powerful torch held underneath the tray can give a good indication when the board is ready. If you can still see

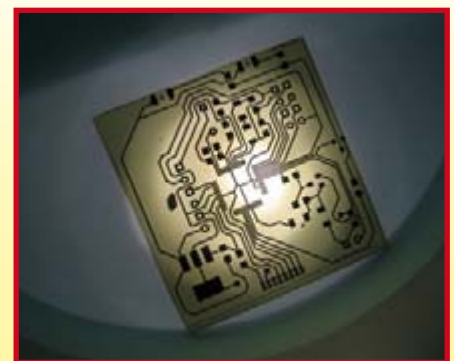

bridges between pins and tracks that shouldn't be there, you know it's not ready yet. After etching you should rinse the board under tap water. The toner can be removed with an abrasive pad or a solvent (thinner), which then reveals the shiny copper layer. If you're still not certain that all copper bridges have gone, now is

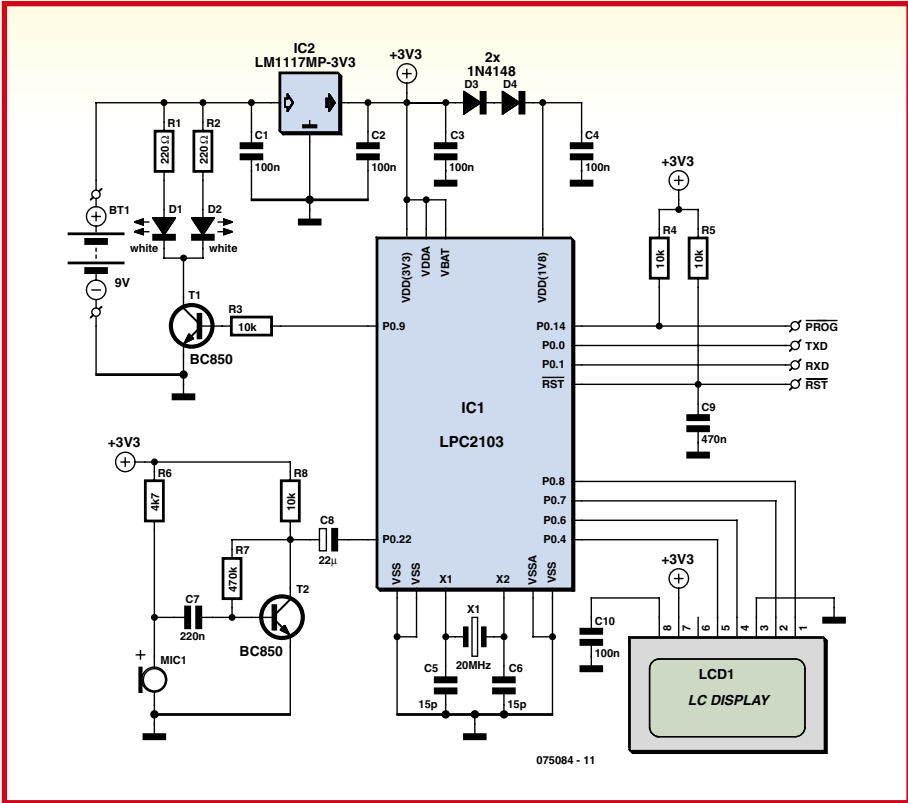

Figure 1. Due to the high level of integration on the LPC2103 we need very little external hardware.

the display output. The audio input routine reads the A/D converter at regular intervals and stores the results in a buffer. Simple effects can use the contents of this buffer directly. For an oscilloscope-like effect, for example, this is sufficient. The more advanced effects however, need to perform a Fast Fourier Transform to determine what frequency components the

music has. Here too we see the advantage of programming in C. Instead of programming the routine from scratch, it was easy to find a public domain fast integer-based FFT routine on the Internet, which was added to the project without too much of a problem.

The effects themselves were already well-known from the demo world:

Demo Contests were competitions where groups of programmers competed against each other to create the best effects using as little program memory as possible. Although the demo scene has moved on to more modern hardware (astounding effects can be created with the current 3D cards), a number of the older effects is still available, well documented and suitable for addition to our limited hardware. A plasma effect or a roto zoomer (code that rotates an image and zooms in at the same time) can be implemented quickly and easily. Add some music dependency to them and it becomes fairly simple to create stunning effects.

Image compression

Although you would think that the routines that transfer the nice images to the screen would be fairly straightforward, the reality is very different. Despite 8K of RAM in the LPC2103, which is generous compared to earlier 8-bit microcontrollers, you'll find it's not really enough when images have to be moved around. To clarify this: the size of the Nokia LCD is 98x67 pixels. The pixels each consist of a red, green and blue sub-pixel, which can have one of 16 'grey scales'. In total this makes for 12 bits per pixel. It would require 9.6Kbytes to store a copy of the image in RAM. Since we only have 8K available, we'll have to use a little trick to reduce the amount of RAM used.

An often-used one is to have a lookup table for the colour palette. We allocate only a single byte per pixel, which re-

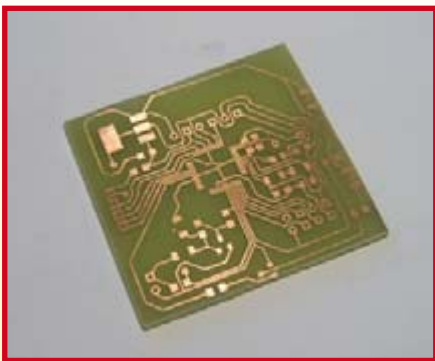

the time to check with a multimeter for shorts and carefully remove any with a sharp knife. Next comes the soldering of the 48-pin IC that will perform all the calculations. Although this may look like a daunting task, with experience it can be done more quickly than the soldering of a large DIP IC.



Position the IC carefully and solder it at two corners. Make sure that all pins are firmly on the pads, as this is very important for the next steps. You should now pretend that you have an IC with four large pins: on each side of the IC put down a good blob of solder. From each side you should now remove the surplus solder using

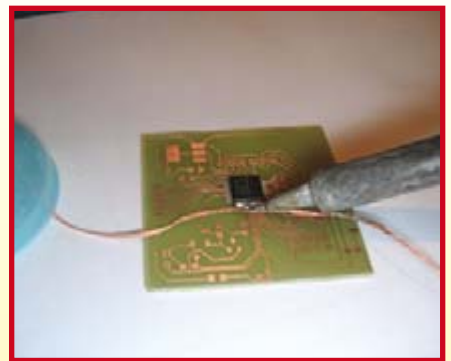

a solder wick. The space between the IC pins and the pads is too small for the wick to get to, leaving pins neatly soldered to the pads. If you suspect that you have a solder bridge, check it with a multimeter and remove it with more solder wick, or with a thin bladed knife if that still didn't work.

sults in 256 different pixel values. In order to use the full 12-bit colour depth we create a table that shows what 12-bit colour corresponds to each of the 256 pixel values. This has other advantages as well. Changing a few values in the table provides an effect with varying colour patterns.

In this way the memory taken up by the LCD is reduced to only 6.9 kBytes. This is still a large proportion of that available. Some other routines, such as the FFT routine, also need a lot of memory and they regularly use the display RAM as a temporary storage area. Despite the tricks used, the display routines are fairly straightforward. Take a pixel value, look up the colour, send it to the LCD and repeat this for every pixel on the LCD. The data is sent to the LCD via a synchronous serial protocol (SPI), which is supported by the internal hardware of the LPC2103. This guarantees that we can send enough images per second to the display to produce a smooth animation.

Programming

To create the machine code required to program the microcontroller, we'll make use of the open-source GCC compiler. The source code itself is also open-source and comes under GPL license version 3. This permits you to adapt the software yourself. The code can be downloaded from [1] and [2]. To make changes to the code under Windows we'd recommend the Winarm package [3]. If you want to program the supplied code into the microcontroller

you only need the flash tool [4]. This doesn't require a programming device and the controller can be programmed on the board. We'll remind you again that this requires an RS232 to 3.3V-TTL converter. Apart from a GSM data cable or a MAX3232 we can also use a USB to serial converter chip, such as the FT232. This chip already works at the right voltages. The chip should be connected to TxD, RxD and Ground on the board.

The processor obviously has to be in its programming mode. When the processor has never been programmed before, this happens automatically. In all other cases it has to be done manually, as follows: connect the reset and prog pins to Ground. First disconnect the reset pin, and then the prog pin. The controller will now be in programming mode and the firmware can be programmed into its memory.

(075084-1)

Web Links

- [1] www.elektor.com (month of publication)
- [2] <http://sprite.student.utwente.nl/~jeroen/projects/wavedisp>
- [3] www.siwawi.arubi.uni-kl.de/avr_projects/arm_projects/#winarm
- [4] www.standardics.philips.com/support/techdocs/microcontrollers/zip/flash.isp.utility.lpc2000.zip
- [5] <http://storm.ca/~rheslip/pcbuser.htm>
- [6] <http://sprite.student.utwente.nl/~jeroen/projects/fuser>

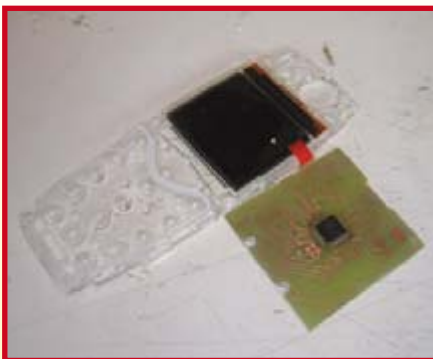
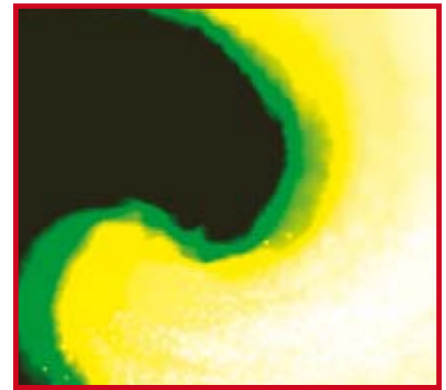
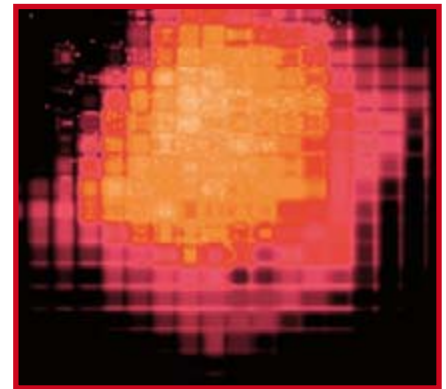
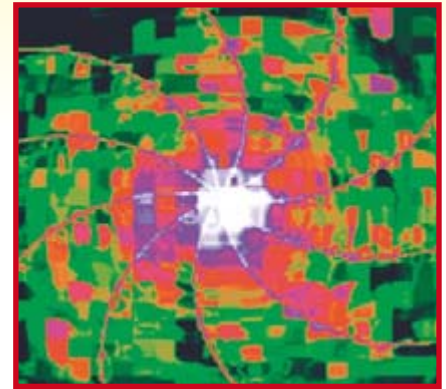

The Nokia 3510i displays often come with a metal cover still attached. This, and the keypad and speaker, aren't required and should be removed using a saw or a pair of cutters. The board is mounted behind the display; the contacts of the display do have to make contact with the board. You should bend them out a bit or use thin piec-



es of wire to make sure of good contact. Next we can mount the other components. For SMD parts a pair of tweezers comes in very useful. You could also use a drop of superglue to keep them in their place. The photos are of a prototype that still has a few faults that have been corrected in the final version. So don't worry if your board

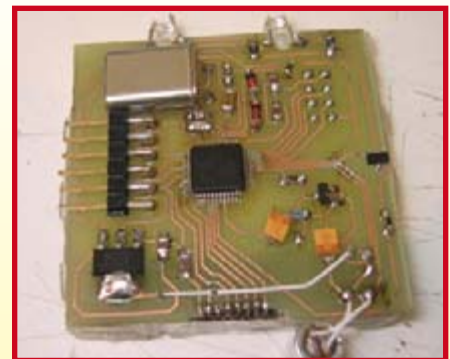

looks a bit different from this one. As an alternative to an iron, you can also use a fuser from a laser printer to transfer the toner. This provides a more even pressure and temperature, which improves the transfer of the toner to the copper cladding. See [5] and [6] for more details.



LogicSim

A free multi-platform logic simulator

Jack Powers

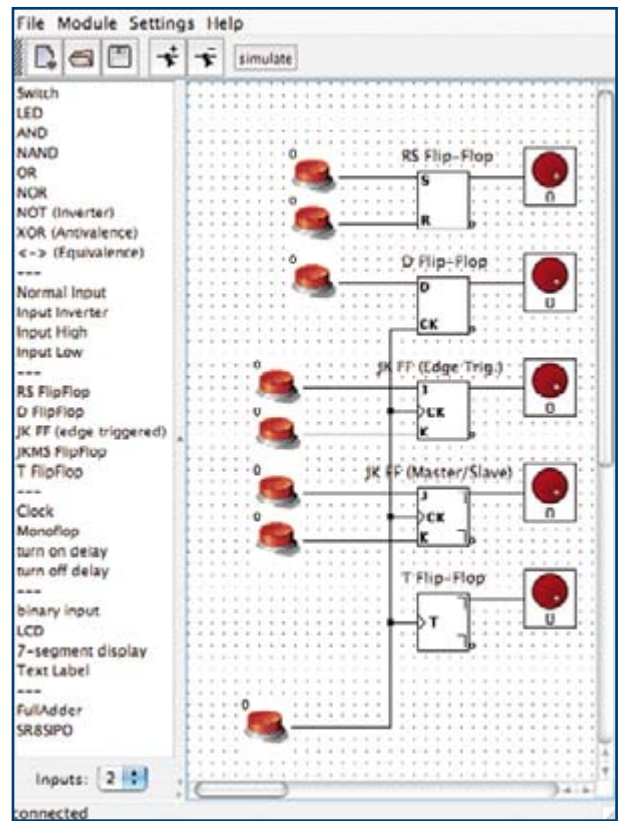

Figure 1.

The drawing area shows one each of the standard flip flops supplied with the program, to which switches and LEDs have been added. Clicking 'simulate' would permit viewing circuit behavior under various conditions set by the switches. Clicking a switch that is 'up' changes its output from 0 to 1 as its icon changes to 'down', and vice versa.

LogicSim by Andreas Tetzl is a Java program that lets you design and debug logic circuits by arranging and interconnecting parts from a library. It comes with several standard logic elements (e.g., And, Or, Not, Flip-Flops, etc.) and you can add to the library yourself as you learn. It supports almost any computer and four spoken languages.

Logic simulation is both a learning tool and an aid to testing real-life circuit designs. Using it is fun because it is so easy (compared to breadboarding real hardware) and provides almost instant feedback. LogicSim has some nice features for controlling the logic you design and seeing the results.

Don't expect, however, to turn on your soldering iron right after your simulated circuits are working. A logic simulator models 'ideal' components, pure rule-based procedures that are missing some of the aspects of real hardware... like noise, actual delays, and loose connections. In addition, the model parts provided in a simulator may not be pin-compatible with parts that you can buy, so some adaptation and debugging will probably be required.

LogicSim is free, supplied according to the terms of the GNU Public License, which also means that the Java source code is available if you want to study or modify it.

You can download a ZIP file containing LogicSim from the author's web site, www.tetzl.de. I used version 2.3.2 dated 2007-06-13, which has some recent improvements.

The ZIP file expands to a folder containing the application program (LogicSim.jar), some sample circuits, and documentation (HTML files in the DOC directory). A very brief (2-page) manual is provided in English, French, Italian, and German. To start up the program, just double click on the LogicSim.jar file.

LogicSim can communicate in four languages: English, French, German and Italian. Language is selected under 'Settings', as is symbol format (IEC or US).

Look And Feel

LogicSim takes a few seconds to start up, then displays a window like **Figure 1** (except that when first started, the drawing window is empty).

Building a circuit consists of selecting a circuit element from the list in the left-hand ('Menu') column, placing it inside the drawing, and then connecting its inputs and outputs with lines to the rest of the circuit. The drawing area contains a grid of points to which blocks and lines are automatically aligned, making it easier to produce a nice looking drawing. The grid can be turned off (using 'Settings') if desired.

To connect an output to an input, click on the output (a short line stub or, for inverted outputs, a small circle) and drag to the destination input's line stub or circle.

If you want to bend a line, just click at the bend point and drag in the new direction. Clicking at the line's destination ends the operation.

Lines may only originate at the output of a circuit element and may only end at an input. You can add or remove a bending point to a line by clicking one of these icons (use + to add and - to remove). Outputs may be connected to multiple destinations either with separate lines originating at an output, or by 'tapping' an existing line and extending it to another destination. The point where you wish to add while holding down the keyboard Shift key; a dot will appear and you can then draw a line to another input. The clock signals in Figure 1 have been extended in this way.

A box labelled 'Simulate' shows whether it is simulating or not. At startup, it is off (white) and operation is best for building and editing circuits.

Once you have a circuit ready for operation, click this box, which will turn grey. Following that, your circuit will be active and changing its inputs will drive its operation.

Jack Powers, retired after 22 years with IBM and additional adventures with several startup companies, has written for computer magazines and is co-author of Megabit Data Communications (Prentice-Hall, 1990).

Some circuit elements have properties which can be edited by right-clicking on them. One of these is the Switch, which normally latches in its new state after clicking it: press on, press off. Right clicking a switch pops up a box which offers two choices: 'Remove Gate' (you probably don't want that, but it is the default, so move the mouse down one line) and 'Properties'. Clicking "Properties" opens another box which offers a choice between 'Toggle-Button' (the default) and 'Click-Button'. If you choose 'Click-Button', during simulation the button will output a '1' only while the mouse is down on it and '0' otherwise... in other words, a momentary switch! Other elements with Properties are Turnon Delay, Turnoff Delay, Clock and Monoflop (timing), Binary Input and LCD (hex or decimal), and Text Label (text content).

Special Inputs

Gates like AND and OR can be added with between 2 and 5 inputs.

LogicSim provides a way to change any gate input into an inverting one using the 'Input Inverter' function. A small circle will appear, to which lines may be attached as before. Testing your circuit may be easier if you can 'force' a 0 or 1 at an (unconnected) input. This may be done by clicking on 'Input Low' or 'Input High' in the menu column followed by clicking the input to be forced.

Creating & using modules

To prevent cluttering up drawings, you can place a circuit in a separate file called a module and use it in another circuit where it appears as a single block. This technique is very powerful. Imagine an exercise in which your logic instructor supplied a 'black box' function with contents unknown to you. (Hints: it has 2 inputs and 1 output, and no memory.) Your assignment is to determine the contents of the module, which you could do with a circuit like the one in **Figure 2**. This circuit provides all 4 combinations of inputs as you activate the clock.

Figure 3 shows one cycle of the simulation of a circuit that is more like those seen in 'real life'. It is a repeating sequence generator built around a shift register with feedback. It includes a decoder for a disallowed state (000) which, if encountered, would cause it to stay in that state forever. Such 'wrinkles' are often seen in logic design, and LogicSim can show them to you before you build something that doesn't work. Finally, Several elements in the Menu column make it easy to control your circuit and to see what it is doing. These are shown in **Figure 4**.

Little Surprises

A few things raised my eyebrows while learning about LogicSim. Of course, the brevity of the manual was a surprise, but experimentation was my friend there. There is a logic element in the menu column called 'Monoflop', a term I had never heard before... so I experimented until I found out what it did. Connecting a switch to a Monoflop's input and an LED to its output and simulating pressing the switch showed that it generated a single pulse for each 0 to 1 input transition. A popular term for this behaviour (at least in the US) is 'single shot' or 'one-shot'. Printing circuits in the drawing area can be problematic,

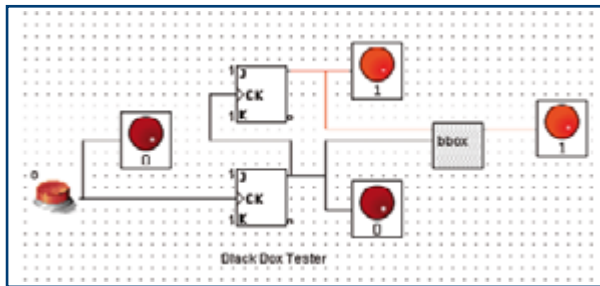

Figure 2. Cycling the clock (by clicking the switch on then off 4 times) supplies all 4 combinations of 2 bits to the bibox module, allowing construction of a truth table for it. Lines carrying '1' signals are shown in red, making it easy to follow operation.

perhaps due to Java quirks. On a Mac, printing worked correctly, except that only Portrait mode was available... I was planning for Landscape mode and edges of my drawing were cut off. On a Windows machine, some drawing lines did not print. My suggestion is to take screen shots and to print those if you have similar problems.

Try it!

The best thing about LogicSim (besides the fact that it actually works, unlike some other free programs) is that it is easy — easy to get, easy to use, and easy to enjoy. Give it a try!

(070463-1)

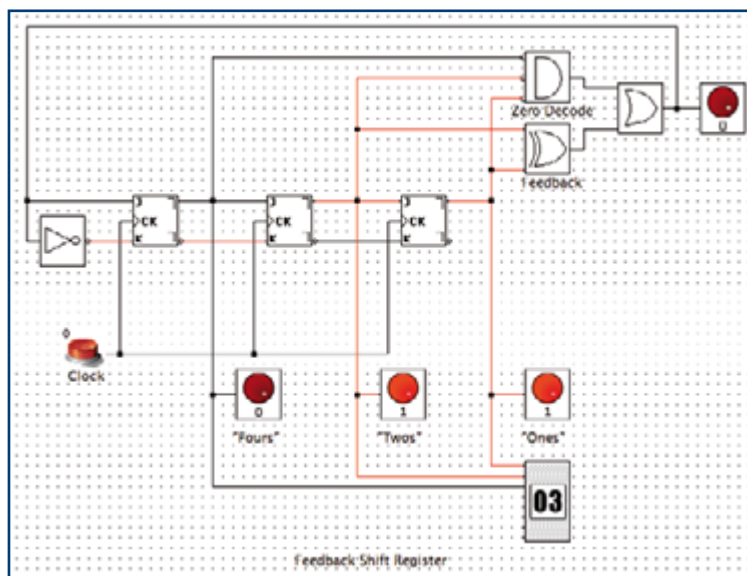

Figure 3. This Feedback Shift Register is clocked with a simulated pushbutton (2 presses required per cycle) and produces an output sequence: 0 (only at first load after the 'simulate' button is clicked), 4, 2, 5, 6, 7, 3, 1, and repeats forever starting with 4 again. The 3-way AND gate with inverted inputs (marked 'Zero Decode') detects the reset (all zeros) condition and forces the circuit into a state which permits continued cyclic output.

Web Links

- www.tetzi.de
- www.kpsec.freeuk.com/gates.htm
- www.ibiblio.org/obp/electricCircuits/Digital/DIGI_3.html

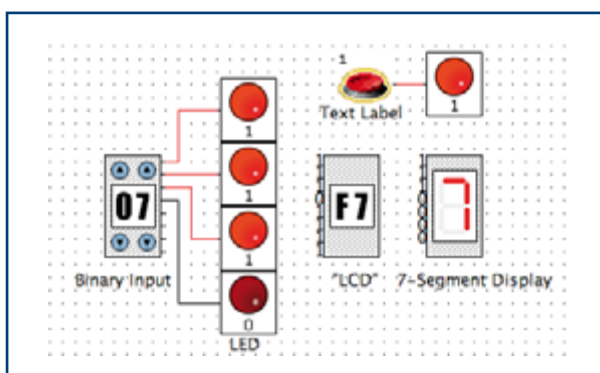

Figure 4. These are circuit elements that you can use to drive your circuit and to watch the results as it runs. The labels are made using the 'Text Label' feature.



08717 Credit Card Sales 177 168

Motor Drivers/Controllers

Here are just a few of our controller and driver modules for AC, DC, Unipolar/Bipolar stepper motors and servo motors. See website for full details.

PC / Standalone Unipolar Stepper Motor Driver

Drives any 5, 6 or 8-lead unipolar stepper motor rated up to 6 Amps max. Provides speed and direction control. Operates in stand-alone or PC-controlled mode. Up to six 3179 driver boards can be connected to a single parallel port. Supply: 9Vdc. PCB: 80x50mm.
Kit Order Code: 3179KT - **£12.95**
Assembled Order Code: AS3179 - **£19.95**



Bi-Polar Stepper Motor Driver

Drive any bi-polar stepper motor using externally supplied 5V levels for stepping and direction control. These usually come from software running on a computer. Supply: 8-30Vdc. PCB: 75x85mm.
Kit Order Code: 3158KT - **£17.95**
Assembled Order Code: AS3158 - **£27.95**



Bi-Directional DC Motor Controller (v2)

Controls the speed of most common DC motors (rated up to 32Vdc, 10A) in both the forward and reverse direction. The range of control is from fully OFF to fully ON in both directions. The direction and speed are controlled using a single potentiometer. Screw terminal block for connections.
Kit Order Code: 3166v2KT - **£17.95**
Assembled Order Code: AS3166v2 - **£27.95**



DC Motor Speed Controller (100V/7.5A)

Control the speed of almost any common DC motor rated up to 100V/7.5A. Pulse width modulation output for maximum motor torque at all speeds. Supply: 5-15Vdc. Box supplied. Dimensions (mm): 60Wx100Lx60H.
Kit Order Code: 3067KT - **£13.95**
Assembled Order Code: AS3067 - **£21.95**



Most items are available in kit form (KT suffix) or assembled and ready for use (AS prefix).

Controllers & Loggers

Here are just a few of the controller and data acquisition and control units we have. See website for full details. Suitable PSU for all units: Order Code PSU445 £8.95

8-Ch Serial Isolated I/O Relay Module

Computer controlled 8-channel relay board. 5A mains rated relay outputs. 4 isolated digital inputs. Useful in a variety of control and sensing applications. Controlled via serial port for programming (using our new Windows interface, terminal emulator or batch files). Includes plastic case 130x100x30mm. Power Supply: 12Vdc/500mA.
Kit Order Code: 3108KT - **£54.95**
Assembled Order Code: AS3108 - **£64.95**



Computer Temperature Data Logger

4-channel temperature logger for serial port. °C or °F. Continuously logs up to 4 separate sensors located 200m+ from board. Wide range of free software applications for storing/using data. PCB just 45x45mm. Powered by PC. Includes one DS1820 sensor.
Kit Order Code: 3145KT - **£17.95**
Assembled Order Code: AS3145 - **£24.95**
Additional DS1820 Sensors - **£3.95 each**



Rolling Code 4-Channel UHF Remote

State-of-the-Art. High security. 4 channels. Momentary or latching relay output. Range up to 40m. Up to 15 Tx's can be learnt by one Rx (kit includes one Tx but more available separately). 4 indicator LED's. Rx: PCB 77x85mm, 12Vdc/6mA (standby). Two and Ten channel versions also available.
Kit Order Code: 3180KT - **£44.95**
Assembled Order Code: AS3180 - **£54.95**



DTMF Telephone Relay Switcher

Call your phone number using a DTMF phone from anywhere in the world and remotely turn on/off any of the 4 relays as desired. User settable Security Password, Anti-Tamper, Rings to Answer, Auto Hang-up and Lockout. Includes plastic case. Not BT approved. 130x110x30mm. Power: 12Vdc.
Kit Order Code: 3140KT - **£54.95**
Assembled Order Code: AS3140 - **£69.95**



Infrared RC Relay Board

Individually control 12 on-board relays with included infrared remote control unit. Toggle or momentary. 15m+ range. 112x122mm. Supply: 12Vdc/0.5A
Kit Order Code: 3142KT - **£47.95**
Assembled Order Code: AS3142 - **£59.95**



PIC & ATMEL Programmers

We have a wide range of low cost PIC and ATMEL Programmers. Complete range and documentation available from our web site.

Programmer Accessories:

40-pin Wide ZIF socket (ZIF40W) **£14.95**
18Vdc Power supply (PSU010) **£18.95**
Leads: Parallel (LDC136) **£395** / Serial (LDC441) **£3.95** / USB (LDC644) **£2.95**

NEW! USB & Serial Port PIC Programmer

USB/Serial connection. Header cable for ICSP. Free Windows XP software. Wide range of supported PICs - see website for complete listing. ZIF Socket/USB lead not included. Supply: 16-18Vdc.
Kit Order Code: 3149EKT - **£39.95**
Assembled Order Code: AS3149E - **£49.95**



NEW! USB 'All-Flash' PIC Programmer

USB PIC programmer for all 'Flash' devices. No external power supply making it truly portable. Supplied with box and Windows Software. ZIF Socket and USB lead not included.
Assembled Order Code: AS3128 - **£44.95**



"PICALL" PIC Programmer

"PICALL" will program virtually all 8 to 40 pin serial-mode AND parallel-mode (PIC16C5x family) programmed PIC micro controllers. Free fully functional software. Blank chip auto detect for super fast bulk programming. Parallel port connection. Supply: 16-18Vdc.
Assembled Order Code: AS3117 - **£24.95**



ATMEL 89xxx Programmer

Uses serial port and any standard terminal comms program. Program/ Read/ Verify Code Data, Write Fuse/Lock Bits, Erase and Blank Check. 4 LED's display the status. ZIF sockets not included. Supply: 16-18Vdc.
Kit Order Code: 3123KT - **£24.95**
Assembled Order Code: AS3123 - **£34.95**



www.QuasarElectronics.com

Secure Online Ordering Facilities • Full Product Listing, Descriptions & Photos • Kit Documentation & Software Downloads

PCB-POOL®

SERVICING YOUR COMPLETE PROTOTYPE NEEDS

1 EUROCARD
(160 x 100 mm)
+ Tooling
+ Photoplots
+ VAT

€49

Price example
Any size and contour possible!

Optional:

- Soldermask
- Fast-turnaround
- Silkscreen
- 4-Layer Multilayer
- 6-Layer Multilayer

FREE LAYOUT SOFTWARE!

Over 18,000 Customers

LEAD FREE

Beta

Freephone  0800-3898560

Tel.: +353 (0)61 701170
Fax: +353 (0)61 701165
pcb-pool@beta-layout.com

Simply send your files and order ONLINE: **PCB-POOL.COM**

ANDRE LAMOTHE'S XGAMESTATION

LEARN STEP-BY-STEP HOW TO BUILD AND DESIGN YOUR OWN VIDEO GAME CONSOLE!

Design inspired by the Atari 800/2600, Sinclair ZX Spectrum, Apple II & Commodore 64!

Parallax SX Key Compatible!

INCLUDES:

- Tools, Demos & Utilities!
- Great for Hobbyists AND Students!
- The Fun Way to Learn Embedded Systems!
- Fully Assembled XGS Micro Edition Unit!
- Complete Software Development Kit!
- eBook on Designing the XGS Console!
- Cables and Power Supply Included!

www.XGAMESTATION.COM
PH: 925.736-2098 | SUPPORT@NURVE.NET

PCBs in 24 hours from £30.00

PCBTrain.com

Tel: 01635 40347
Fax: 01680 361443
e-mail: cinfo@newbury.electronics.co.uk

Newbury Electronics Ltd
Foreday Road, Newbury, Berkshire RG14 2AD
www.newburypicoelectronics.co.uk



No Compromise Oscilloscope

Other oscilloscopes in this price range force you to compromise on one of the key specifications: sampling rate, memory depth or bandwidth.

The PicoScope 5000 series is a no compromise PC oscilloscope at a price every engineer can afford.

www.picotech.com/scope437 01480 396395

pico Technology



- 1GS/s sampling rate
- 250MHz bandwidth
- 128M sample buffer memory
- 125MS/s 12 bit AWG built in

PicoScope 5203
32M buffer £1195

PicoScope 5204
128M buffer £1795

Hexadoku

Puzzle with an electronics touch

With the days shortening and the need to spend more time indoors we reckon our readers can do with a fine puzzle like this month's Hexadoku. Sharpen your pencil, grind your teeth. Send us your solution and enter a prize draw for one of the prizes: an E-blocks Starter Kit Professional and three Elektor Shop vouchers.

The instructions for this puzzle are straightforward.

In the diagram composed of 16 x 16 boxes, enter numbers such that **all** hexadecimal numbers 0 through F (that's 0-9 and A-F) occur once only in each row, once in each column and in each of the 4x4 boxes (marked by the thicker black lines).

A number of clues are given in the puzzle and these determine the start situation.

All correct entries received for each month's puzzle go into a draw for a main prize and three lesser prizes. All you need to do is send us the numbers in the grey boxes. The puzzle is also available as a **free download** from our website.

SOLVE HEXADOKU AND WIN!

Correct solutions received enter a prize draw for an

E-blocks Starter Kit Professional

worth **£248.55**

and three **Elektor SHOP Vouchers** worth £35.00 each.



We believe these prizes should encourage all our readers to participate!

The competition is not open to employees of Elektor International Media b.v., its business partners and/or associated publishing houses.

PARTICIPATE!

Please send your solution (the numbers in the grey boxes) by email to:

editor@elektor.com - Subject: **hexadoku 11-2007**.

Alternatively, by fax or post to: **Elektor Hexadoku Regus Brentford - 1000 Great West Road - Brentford TW8 9HH United Kingdom - Fax (+44) 208 2614447**

The closing date is **1 December 2007**.

PRIZE WINNERS

The solution of the September 2007 puzzle is: **FCEB7**.

The **E-blocks Starter Kit Professional** goes to:

Simona Bernardi-Girardi (F).

An **Elektor SHOP voucher worth £35.00** goes to:

Esko Viiru (FIN); Mauri Kaarnakangas (FIN) and

Henning Björge (N).

Congratulations everybody!

B		F			5	C		0	2						
	4				D	9		6	5	1		F			0
	8	0		2	F	6						D		7	
		5	6				B	7					C		9
F			5	3			6	A	B		0	1		4	7
E	B					A	D	2					8	5	6
	6	3	2		9	B				7	E				F
	1		A			5		4	9			B	E	2	
D			8	6	1		F	C	0		2	7			
	7				E	5	6		F	A				9	2
	A		E	C											
C	9			4		2					8		3		B
	5			7					E	0	6				
	0	E			B	3	C	F	8	9			2		D
		9	7	D							C		8	0	6
A		8	B			2		1	D	4		F			

(c) FZZL.com

B	0	9	3	4	8	6	5	7	A	E	C	1	2	D	F
6	1	F	2	E	3	D	7	5	8	4	9	A	0	B	C
7	C	A	E	2	0	B	F	6	1	D	3	5	8	4	9
8	4	D	5	1	C	9	A	F	B	2	0	6	3	7	E
5	7	C	B	A	6	1	3	0	F	9	2	4	D	E	8
9	F	2	4	D	5	0	8	E	C	B	7	3	1	A	6
E	D	3	1	F	9	2	C	A	4	6	8	B	7	0	5
A	8	6	0	7	B	E	4	D	3	1	5	F	9	C	2
1	9	7	F	6	4	8	2	3	D	A	B	C	E	5	0
2	A	4	D	B	E	3	0	C	9	5	F	8	6	1	7
3	E	5	6	C	7	F	D	4	0	8	1	2	B	9	A
C	B	0	8	9	A	5	1	2	6	7	E	D	4	F	3
0	3	B	A	8	D	7	9	1	5	C	6	E	F	2	4
D	5	1	7	0	2	4	6	8	E	F	A	9	C	3	B
F	6	E	C	3	1	A	B	9	2	0	4	7	5	8	D
4	2	8	9	5	F	C	E	B	7	3	D	0	A	6	1

Philips type ESC 'Semafoon' Pager (1962)

Jan Buiting

In 1963, after about two years of administrative preparation, a lot of telexing, white papering and contract tendering, the Dutch PTT officially launched its nationwide personal pager service called 'semafoon' (semaphone). Philips Telecommunications Industry (PTI) were contracted to supply portable pagers for message signalling to, what was expected at the time, no more than 10,000 individual subscribers. The system was simple: anyone could dial the national semaphore telephone number, followed by the subscriber number and a message code. The number strings so assembled were broadcast using sequences of four AF tones (with up to 20 different frequencies) transmitted at about 86 MHz. As we're talking about NBFM with approx. 50 kHz bw, just three transmitters were sufficient to cover all of The Netherlands with sufficient field strength. The highest transmitter was IJsselstein with an antenna height of 375 m and an ERP of about 10 kW.

Originally, the Dutch PTT wanted to use the name 'simofoon' for the system but they were thwarted by Siemens lawyers for obvious reasons and quickly changed to 'semafoon'. PTI's commercial department was not bothered by this and continued to use 'type ESC' for the pager they were selling to PTT, probably inferring the tech guys at PTI used the designation 8MO520 only.

The ESC pager was hailed as a great technical achievement at the time because it was an all-transistor, portable device. In practice, you were hauling about 4.5 kgs worth of rented electronics as the ESC works off ten (!) C size 1.5 V batteries. Racks for installation at home or in vehicles were available as optional accessories.

The message code as seen by the subscriber is 1, 2, 3, 4, 5 or 6 and has to be calculated from up to two white lamps that light

on the ESC front panel. Three lamps are available, labelled '1', '2' and '4'. Imagine receiving messages like:

1 + 4 = 5 = *patient #5 critical*;
2 + 4 = 6 = *call the missus*;
2 only = 2 = *WiFi down, boss eating the carpet*.

Obviously, the meaning of the message codes were agreed beforehand. A spring-operated paper clamp on the ESC front panel allowed a small note to be secured to help as a reminder for the code meanings.

Each code was transmitted two times, the second 'jingle' arriving after 20 seconds to cater for vehicles in tunnels etc. Reportedly some semaphone users were able to recognize their own subscriber code (and that of competitors in their line of business) by ear from the continuous stream of 'tone music' heard from a VHF FM radio tuned to 86 MHz.

For rare collectables, I have the original 8MO520 schematics and extremely detailed parts lists from 1962, as well PTI's own 'number 0000' ESC pager which was used for a demonstration to the assembled technical press just before the launch of the semaphone service in May 1963. This ESC was not finished and did not work. The demo was faked — the ESC proudly shown to the press was specially wired up to respond to a PTT or PTI staff member pressing a hidden switch (suspiciously long table cloth draping to the ground...) when his colleague dialled the subs number and message code on a telephone in the press room. The telephone and transmitter parts of the system worked, however, as the tone sequences were audible to all from an ordinary VHF FM receiver.

The Dutch semaphone personal pager system remained in operation, basically unchanged but with more advanced and lighter pagers of course, till about ten years ago. At its peak it serviced over 375,000 subscribers.

(075097-1)

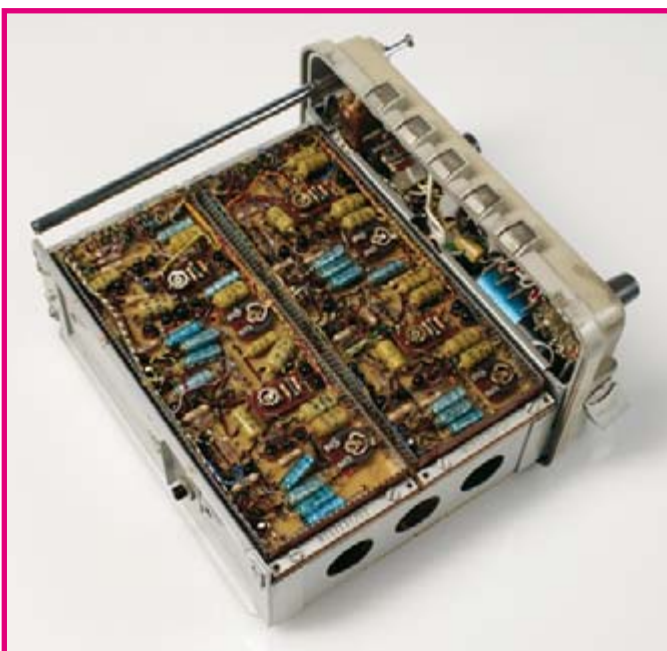

Retronics is a monthly column covering vintage electronics including legendary Elektor designs. Contributions, suggestions and requests are welcomed; please send an email to editor@elektor.com

ELEKTOR SHOWCASE

To book your showcase space contact Huson International Media

Tel. 0044 (0) 1932 564999 Fax 0044 (0) 1932 564998

ATC SEMITEC LTD

www.atcsemitec.co.uk

Thermal and current-sensitive components for temperature control and circuit protection;

- NTC Thermistors
- Current Diodes
- Thermostats
- Re-settable Fuses
- Thermal Fuses
- Temperature Sensors

Call today for free samples and pricing

Tel: 01606 871680 Fax: 01606 872938

AVIT RESEARCH

www.avitresearch.co.uk

USB has never been so simple... with our USB to Microcontroller Interface cable. Appears just like a serial port to both PC and Microcontroller, for really easy USB connection to your projects, or replacement of existing RS232 interfaces.



See our webpage for more details. From £15.00.

BETA LAYOUT

www.pcb-pool.com

Beta layout Ltd Award-winning site in both English and German offers prototype PCBs at a fraction of the cost of the usual manufacturer's prices.



BOWOOD ELECTRONICS LTD

www.bowood-electronics.co.uk

Suppliers of Electronic Components

- Semiconductors
- Opto Electronics
- Passives
- Enclosures
- Switches
- Stripboard
- PCB Materials
- Popular Special Offer Packs

Online Store, all major cards

Same day despatch upto 3.00pm

Personal Service sales@bowood-electronics.co.uk

BYVAC ELECTRONICS

www.byvac.co.uk

32Bit ARM

Microcontroller, USB, built in RTC with it's own operating system, no complex tools, just a

terminal emulator, start writing programs in 20 minutes. Complete with CD-ROM, Software and 100 Page Foundation book



DECIBIT CO.LTD.

www.decibit.com

Smallest 2.4 GHz ISM band MCU embedded transceiver modules. Complete tiny solution, ready to transmit RF data by only attaching as example a CR2032 coin cell to it.



EasyDAQ

www.easydaq.biz

We design & supply low cost USB/RS232 based data acquisition, automation & control products:

- USB connected & powered, 8 opto isolated voltage inputs chans, 4DIO & 4 onboard relays capable of switching 240V@10A. With Labview, VC & VB examples - £60



EASYSYNC

<http://www.easysync.co.uk>

EasySync Ltd sells a wide range of single and multi-port USB to RS232/RS422 and RS485 converters at competitive prices.



ELNEC

www.elnec.com

- device programmer manufacturer
- selling through contracted distributors all over the world
- universal and dedicated device programmers
- excellent support and after sale support
- free SW updates
- reliable HW
- once a months new SW release
- three years warranty for most programmers



FIRST TECHNOLOGY TRANSFER LTD.

<http://www.ftt.co.uk/PICProTrng.html>

Microchip Professional C and Assembly Programming Courses.

The future is embedded.

Microchip Consultant / Training Partner developed courses:

- Distance learning / instructor led
- Assembly / C-Programming of PIC16, PIC18, PIC24, dsPIC microcontrollers
- Foundation / Intermediate



FLEXIPANEL LTD

www.flexipanel.com

TEAclippers - the smallest PIC programmers in the world, from £20 each:

- Per-copy firmware sales
- Firmware programming & archiving
- In-the-field firmware updates
- Protection from design theft by subcontractors



FUTURE TECHNOLOGY DEVICES

<http://www.ftdichip.com>

FTDI designs and sells USB-UART and USB-FIFO interface i.c.'s.

Complete with PC drivers, these devices simplify the task of designing or upgrading peripherals to USB



FUTURLEC

<http://www.futurlec.com>

Save up to 60% on

- Electronic Components
 - Microcontrollers, PIC, Atmel
 - Development Boards, Programmers
- Huge range of products available on-line for immediate delivery, at very competitive prices.



LONDON ELECTRONICS COLLEGE

<http://www.lec.org.uk>

Vocational training and education for national qualifications in Electronics Engineering and Information Technology (BTEC First National, Higher National NVQs, GCSEs and Advanced Qualifications). Also Technical Management and Languages.

MARCHAND ELECTRONICS INC.

www.marchandelec.com

- power amplifier modules
- electronic crossovers solid state / valve / passive
- valve amplifiers
- phono preamps
- handheld sinewave generator
- kits or assembled
- software electronic instruments
- custom design services



products and services directory

MQP ELECTRONICS

www.mqp.com

- Low cost USB Bus Analysers
- High, Full or Low speed captures
- Graphical analysis and filtering
- Automatic speed detection
- Bus powered from high speed PC
- Capture buttons and feature connector
- Optional analysis classes



ROBOTIQ

<http://www.robotiq.co.uk>

Build your own Robot!
Fun for the whole family!

- Meccano™ Compatible
- Computer Control
- Radio Control
- Tank Treads
- Hydraulics

Internet Technical Bookshop,
1-3 Fairlands House, North Street, Carshalton,
Surrey SM5 2HW
email: sales@robotiq.co.uk Tel: 020 8669 0769



USB INSTRUMENTS

<http://www.usb-instruments.com>

USB Instruments specialises in PC based instrumentation products and software such as Oscilloscopes, Data Loggers, Logic Analysers which interface to your PC via USB.



NEW WAVE CONCEPTS

www.new-wave-concepts.com

Software for Hobbyists:

- Livewire - circuit simulation software, only £34.99
- PCB Wizard - PCB design software, only £34.99
- Circuit Wizard - circuit, PCB and breadboard design software, only £59.99



Available from all Maplin Electronics stores and www.maplin.co.uk

COMPONENTBIN.COM

www.componentbin.com

Kickstart your development with modules and parts from componentbin.com

- ARM7 modules
- Ethernet modules
- Superb Graphic LCD displays (all with example software)

and much much more...
Online ordering and great prices!



ROBOT ELECTRONICS

<http://www.robot-electronics.co.uk>

Advanced Sensors and Electronics for Robotics

- Ultrasonic Range Finders
- Compass modules
- Infra-Red Thermal sensors
- Motor Controllers
- Vision Systems
- Wireless Telemetry Links
- Embedded Controllers



ULTRALEDS

[Ultraleds.co.uk](http://www.ultraleds.co.uk)

<http://www.ultraleds.co.uk>

tel: 0871 7110413 / 01625 576778
Large range of low cost Ultra bright leds and Led related lighting products. Major credit cards taken online with same day depatch.

www.elektor.com

SHOWCASE YOUR COMPANY HERE

Elektor Electronics has a feature to help customers promote their business, Showcase - a permanent feature of the magazine where you will be able to showcase your products and services.

- For just £220 + VAT (£20 per issue for eleven issues) Elektor will publish your company name, website address and a 30-word description
- For £330 + VAT for the year (£30 per issue for eleven issues) we will publish the above plus run a 3cm deep full colour

image - e.g. a product shot, a screen shot from your site, a company logo - your choice

Places are limited and spaces will go on a strictly first come, first served basis. So-please fax back your order today!

I wish to promote my company, please book my space:

- Text insertion only for £220 + VAT
- Text and photo for £330 + VAT

NAME: ORGANISATION:

JOB TITLE:

ADDRESS:

..... TEL:

PLEASE COMPLETE COUPON BELOW AND FAX BACK TO 00-44-(0)1932 564998

COMPANY NAME

WEB ADDRESS

30-WORD DESCRIPTION

.....

.....

.....

.....

Going Strong

A world of electronics
from a single shop!

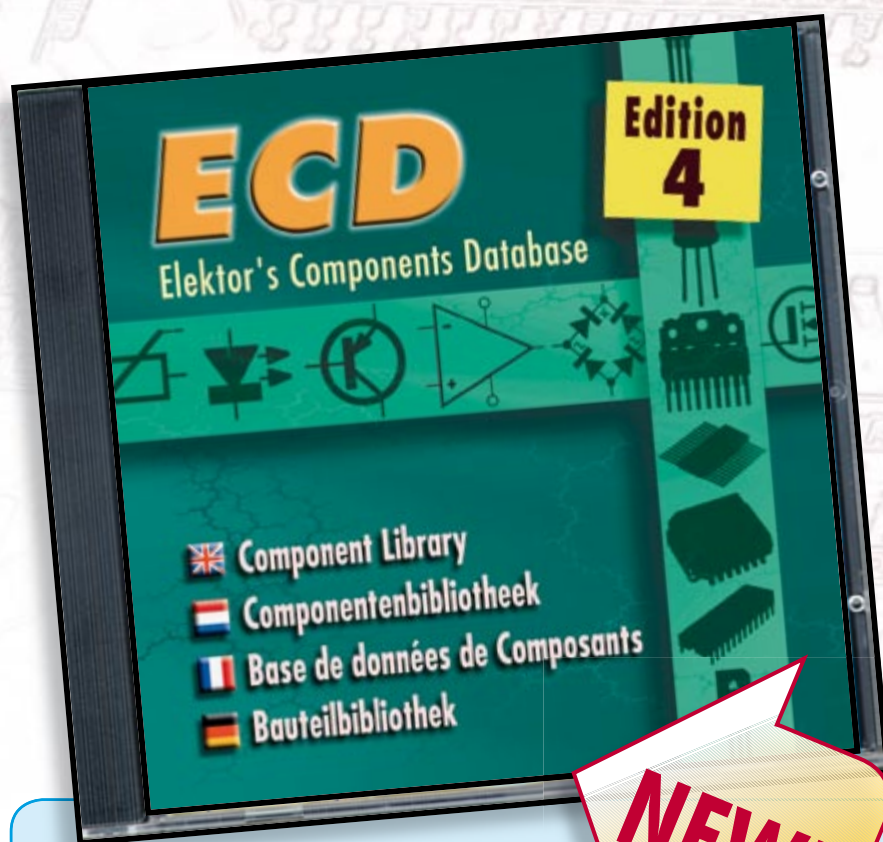

More than 68,000 components

Elektor's Components Database 4

The program package consists of eight databanks covering ICs, germanium and silicon transistors, FETs, diodes, thyristors, triacs and optocouplers. A further eleven applications cover the calculation of, for example, LED series droppers, zener diode series resistors, voltage regulators and AMVs. ECD 4 gives instant access to data on more than 68,000 components. All databank applications are fully interactive, allowing the user to add, edit and complete component data. This CD-ROM is a must-have for all electronics enthusiasts.

ISBN 978-90-5381-159-7 • £15.90 • US\$ 31.80



Software Tools & Hardware Tips

Ethernet Toolbox

This CD-ROM contains all essential information regarding Ethernet interfaces! Ethernet Toolbox includes a collection of datasheets for dedicated Ethernet interface ICs from many different manufacturers. To help you with your own projects, the CD-ROM provides a wealth of information about connectors and components for the physical layer (PHY) and specific software tools for use with the Ethernet (Software). Of course, none of the Elektor articles on the subject of Ethernet are missing on this CD-ROM.

ISBN 978-90-5381-214-3 • £18.90 • US\$ 37.90



Embedded USB Know How

USB Toolbox

This CD-ROM contains all the essential information a designer needs to start working with the USB interface. It includes a large collection of datasheets for specific USB components from a wide range of manufacturers. USB Toolbox provides information on all ICs suitable for different applications. A sub-division has been made in controllers, hubs, microcontrollers and others.

ISBN 978-90-5381-212-9 • £19.90 • US\$ 39.80

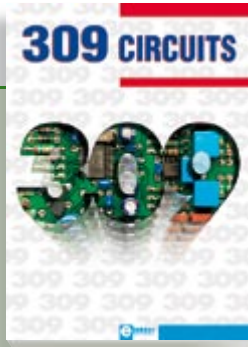

Fully elaborated electronics projects

309 Circuits

The present tenth edition of the popular '30x Circuits' series of books once again contains a comprehensive variety of circuits, sub-circuits, tips and tricks and design ideas for electronics. Among many other inspiring topics, the following categories are well presented in this book: test & measurement; RF (radio); computers and peripherals; audio & video; hobby and modelling; microcontrollers; home & garden; power supplies & battery chargers; etcetera.

432 pages • ISBN 978-0-905705-69-9
£19.95 • US\$ 39.95



Learn more about them

Microcontroller Basics

This book offers more than just a basic introduction! It clearly explains the technology using various microcontroller circuits and programs written in several different programming languages. In the course of the book, the reader gradually develops increased competence in converting his or her ideas into microcontroller circuitry.

230 pages • ISBN 978-0-905705-67-5
£19.50 • US\$ 39.00

NEW!

USB Flash Board

(November 2007)

Flash microcontrollers are easy to program. In the past, program code was usually downloaded via a serial interface, but nowadays many PCs only have USB ports. Our versatile Flash Board provides a solution to this problem. It is built around an AT89C5131A, which is an extended 8051-family microcontroller with an 80C52 core and a Full Speed USB port. As a sort of bonus, the IC has a complete update interface for downloading new firmware. Atmel also provides suitable software in the form of its FLIP program, which is available free of charge.

Construction kit including the PCB and all parts

Art. # 070125-71 - Price on application

More information on the brand
new Elektor Website:
www.elektor.com

Elektor
Regus Brentford
1000 Great West Road
Brentford TW8 9HH
United Kingdom
Tel.: +44 208 261 4509
Fax: +44 208 261 4447
Email: sales@elektor.com

elektor
SHOP



ElekTrack

(October 2007)

Position determination is all the rage. The alarm systems of expensive cars and other vehicles often comprise positioning systems so they can report where the vehicle is located. However, such systems are rather expensive, so we decided to take the DIY approach and develop our own version, dubbed ElekTrack. Due to the large number of SMD components and the difficulty of soldering such components, we decided to supply this module fully assembled only.

Art. # 070038-72 • £55.20 • US\$ 110.40

PCB, ready assembled and tested, GPS/GMS-antenna, cable and case

Art.# 040161-91 • £270.00 • US\$ 540.00

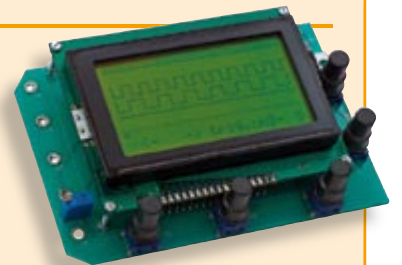

Digital Inspector

(September 2007)

When checking digital signals a logic analyser is indispensable, especially since many circuits use microcontrollers these days. This four-channel logic analyser is compact and battery-powered. The maximum sampling rate is 2 MHz and the circuit has sufficient memory to store 1024 samples of the signal. The dot-matrix display with a resolution of 64 by 128 pixels shows a clear representation of the digital signals.

Construction kit including the PCB, controller, display, case and all parts

Art. # 060092-71 • £77.60 • US\$ 155.20

November 2007 (No. 371)

£ US\$

USB Data Acquisition Card

070148-1 PCB, bare 9.50 19.00
070148-41 PIC18F4550 DIP40, programmed 15.50 31.00
070148-81 Software on CD-ROM 5.20 10.40

Line Switcher

060288-1 PCB, bare www.thePCBshop.com
----------	-----------------	-------	--------------------------

Headphone Amp with 3D Sound

070393-1 PCB, bare www.thePCBshop.com
----------	-----------------	-------	--------------------------

Low-cost Heating Controller

060325-1 Printed circuit board 9.60 19.20
060325-41 Programmed controller ATmega32-16PU 15.80 31.60

USB Flash Board

070125-1 PCB, bare 17.90 35.80
070125-71 Kit of parts, PCB and all parts POA POA
070125-81 Software on CD-ROM 5.20 10.40

October 2007 (No. 370)

ElekTrack

040161-91 PCB, ready assembled and tested, GPS/GSM-antenna, cable and case 275.00 550.00
-----------	---------------------------------------------------------------------------	--------------	--------------

USBprog

060224-1 Printed circuit board www.thePCBshop.com
060224-71 PCB, SMD populated plus other parts 18.80 37.80
060224-81 Software on CD-ROM 5.20 10.40

Mugen: A Hybrid Audio Amplifier

070069-1 Printed circuit board, amplifier (mono) 20.70 41.40
070069-2 Printed circuit board, power supply 19.30 38.60

September 2007 (No. 369)

Tilt Gamepad

070233-41 Programmed controller ATmega8-16PI 6.20 12.35
070233-81 Software on CD-ROM 5.20 10.40
070233-91 Printed circuit board with sensor fitted 18.90 37.80

Digital Inspector

060092-1 Printed circuit board www.thePCBshop.com
060092-41 Programmed controller PIC18F4580-I/P 13.10 26.20
060092-71 Kit of parts PCB, controller, case and all parts 77.60 155.20
060092-81 Software on CD-ROM 5.20 10.40

July/August 2007 (No. 367)

Dual Battery

070343-1 PCB, bare 5.20 9.75
----------	-----------------	------------	------------

Fast Charger for NiMH Batteries

070213-1 PCB, bare www.thePCBshop.com
----------	-----------------	-------	--------------------------

Lithium Charger

070273-1 PCB, bare 8.90 12.95
----------	-----------------	------------	-------------

Low2 Cost USB Demo Board

060342-81 CD-ROM, project software 5.20 9.75
060342-41 PIC18F4550, programmed 15.15 28.50

LPC 900 Programmer

070084-1 PCB, bare 6.90 12.95
----------	-----------------	------------	-------------

MotoBox

070129-1 PCB, bare www.thePCBshop.com
070129-41 PIC16F628-04/P, programmed 14.80 27.95

Propeller Prototyping Board for BoeBot

070275-1 PCB, bare 11.00 20.75
----------	-----------------	-------------	-------------

Satnav for Robots

070350-81 CD-ROM, project software 5.20 9.75
070350-41 ATmega32, programmed 16.50 31.15

Serial Interface for the Propeller

070276-1 PCB, bare www.thePCBshop.com
----------	-----------------	-------	--------------------------

Stereo Robot Ears

060040-1 PCB, bare www.thePCBshop.com
060040-81 CD-ROM, project software 5.20 9.75
060040-41 PIC16F88, programmed 10.00 18.85

Bestsellers

Books

- ➔ **309 Circuits**
ISBN 978-0-905705-69-9 £19.95 US\$ 39.95
- ➔ **Visual Basic** for Electronics Engineering Applications
ISBN 978-0-905705-68-2 £29.00 US\$ 58.00
- ➔ **Microcontroller Basics**
ISBN 978-0-905705-67-5 £19.50 US\$ 39.00
- ➔ **PC Interfaces under Windows**
ISBN 978-0-905705-65-1 £27.25 US\$ 54.50
- ➔ **Designing Audio Circuits**
ISBN 978-0-905705-50-7 £20.75 US\$ 41.50

CD-ROMs

- ➔ **Ethernet Toolbox**
ISBN 978-90-5381-214-3 £18.90 US\$ 37.90
- ➔ **USB Toolbox**
ISBN 978-90-5381-212-9 £19.90 US\$ 39.80
- ➔ **Home Automation**
ISBN 978-90-5381-195-5 £13.90 US\$ 27.80
- ➔ **Elektor 2006**
ISBN 978-90-5381-207-5 £16.90 US\$ 33.80
- ➔ **Robotics**
ISBN 978-90-5381-179-5 £12.90 US\$ 25.80

Kits & Modules

- ➔ **Stand Alone OBD-2 Analyser**
Art. # 070038-72 £55.20 US\$ 110.40
- ➔ **Digital Inspector**
Art. # 060092-71 £77.60 US\$ 155.20
- ➔ **ElekTrack**
Art. # 040161-91 £275.00 US\$ 550.00
- ➔ **Software Defined Radio**
Art. # 070039-91 £72.45 US\$ 126.50
- ➔ **Tilt Gamepad**
Art. # 070233-91 £18.90 US\$ 37.80

Order online at

www.elektor.comor use the Order Form near the end
of the magazine!

Elektron
Regus Brentford
1000 Great West Road
Brentford TW8 9HH • United Kingdom
Tel. +44 208 261 4509
Fax +44 208 261 4447
Email: sales@elektor.com



“Elektor? If our teachers knew just how easily some concepts can be explained...”

– Daniel Judd, 23, student –

Electronics at all the right levels

Secure a head start in electronics with a Student Subscription!*

Advantages to subscribers:

- ✓ Students qualify for a discount of no less than **20%** compared to the normal price of an annual subscription
- ✓ Subscribers get up to **40% discount** on special Elektor products
- ✓ No queues, travelling, parking fees or ‘sold out’ Elektor is supplied to your doorstep every month
- ✓ Always up to date – read your copy before everyone else



* Only available in UK. Ask for the conditions.

www.elektor.com/subs
Tel. +44 (0) 208 261 4509

elektor
electronics worldwide

Extra: Elektor's i-TRIXX Collection

It's starting to become a tradition! With the December issue of Elektor comes a 24-page free supplement called i-TRIXX Collection. These free pages contains about 20 circuits, pulled from the Elektor lab and from our large circle of free-lance contributing authors. Although this year's collection is again aimed at those of you starting out in electronics, or on a modest budget, scavenging components from the junk box, we know that the circuits presented also have an appeal if you just want to make something quickly in an afternoon or so.



Electronic Experimenting Kits

Many of you now proud to call themselves an 'electronics enthusiast' or a 'pro' started out in the field by assembling simple circuits from an electronics experimenters kit. As we show in this article, these kits are not things of the past — far from it, a wide assortment is on sale catering for various ages, levels and budgets, with projects ranging from the humble crystal receiver right up to microcontroller applications. Our overview of available kits should help you pick a Christmas present for a youngster.

SMD Reflow Oven Controller

Back in the January 2006 issue we showed an idea on converting a low-cost household-ish electric oven into a reflow oven for controlled soldering of SMD circuit boards. The project turned out so popular we designed a more repeatable version of the heater control circuitry. This circuit contains an AT89S8253 microcontroller and an LCD showing temperature characteristics and several user functions.



RESERVE YOUR COPY NOW!

UK mainland subscribers will receive the magazine between 16 and 20 November 2007.

The December 2007 issue goes on sale on Thursday 22 November 2007 (UK distribution only).

Article titles and magazine contents subject to change, please check www.elektor.com.

NEWSAGENTS ORDER FORM

SHOP SAVE / HOME DELIVERY

Please save / deliver one copy of Elektor magazine for me each month

Name:

Address:

Post code:

Telephone:

Date:

Signature:



Please cut out or photocopy this form, complete details and hand to your newsagent.
 Elektor is published on the third Thursday of each month, except in July.
 Distribution S.O.R. by Seymour (NS).

www.elektor.com www.elektor.com www.elektor.com www.elektor.com www.elektor.com

Elektor on the web

All magazine articles back to volume 2000 are available online in pdf format. The article summary and parts list (if applicable) can be instantly viewed to help you positively identify an article. Article related items are also shown, including software downloads, circuit boards, programmed ICs and corrections and updates if applicable. Complete magazine issues may also be downloaded.

In the Elektor Shop you'll find all other products sold by the publishers, like CD-ROMs, kits and books. A powerful search function allows you to search for items and references across the entire website.

Also on the Elektor website:

- Electronics news and Elektor announcements
- Readers Forum
- PCB, software and e-magazine downloads
- Surveys and polls
- FAQ, Author Guidelines and Contact



Description	Price each	Qty.	Total	Order Code
ElekTrack NEW	£275.00			
309 Circuits NEW	£19.95			
CD-ROM ECD 4 NEW	£15.90			
Formula Flowcode Buggy	£85.00			
Sub-total				
P&P				
Total paid				



Prices and item descriptions subject to change. The publishers reserve the right to change prices without prior notification. Prices and item descriptions shown here supersede those in previous issues. E. & O.E.

METHOD OF PAYMENT
(see reverse before ticking as appropriate)

Bank transfer

Cheque
(UK-resident customers ONLY)

Giro transfer

Expiry date: _____

Verification code: _____

Please send this order form to*
(see reverse for conditions)

Elektor
Regus Brentford
1000 Great West Road
Brentford TW8 9HH
United Kingdom

Tel.: +44 208 261 4509
Fax: +44 208 261 4447
www.elektor.com
sales@elektor.com

*USA and Canada residents may (but are not obliged to) use \$ prices, and send the order form to: Old Colony Sound Lab P.O. Box 876, Peterborough NH 03458-0876. Tel. (603) 924-6371, 924-6526, Fax: (603) 924-9467
Email: custserv@audioXpress.com

Name _____

Address + Post code _____

Tel. _____ Email _____

Date - - 2007 Signature _____

EL11



Yes, I am taking out an annual subscription to Elektor and receive a free 1GB MP3 player.

I would like:

- Standard Subscription (11 issues)**
- Subscription-Plus (11 issues plus the Elektor Volume 2007 CD-ROM)**



* Offer available to Subscribers who have not held a subscription to Elektor during the last 12 months. Offer subject to availability. See reverse for rates and conditions.

Name _____

Address + Post code _____

Tel. _____ Email _____

Date - - 2007 Signature _____

* cross out what is not applicable



EL11

METHOD OF PAYMENT
(see reverse before ticking as appropriate)

Bank transfer

Cheque
(UK-resident customers ONLY)

Giro transfer

Expiry date: _____

Verification code: _____

Please send this order form to

Elektor
Regus Brentford
1000 Great West Road
Brentford TW8 9HH
United Kingdom

Tel.: +44 208 261 4509
Fax: +44 208 261 4447
www.elektor.com
subscriptions@elektor.com

ORDERING INSTRUCTIONS, P&P CHARGES

Except in the USA and Canada, all orders, except for subscriptions (for which see below), must be sent BY POST or FAX to our Brentford address using the Order Form overleaf. On-line ordering: <http://www.elektor.com>

Readers in the USA and Canada may (but are not obliged to) send orders, except for subscriptions (for which see below), to the USA address given on the order form. Please apply to Old Colony Sound for applicable P&P charges. Please allow 4-6 weeks for delivery.

Orders placed on our Brentford office must include P&P charges (Priority or Standard) as follows: Europe: £6.00 (Standard) or £7.00 (Priority) Outside Europe: £9.00 (Standard) or £11.00 (Priority)

HOW TO PAY

All orders must be accompanied by the full payment, including postage and packing charges as stated above or advised by Customer Services staff.

Bank transfer into account no. 40209520 held by Elektor Electronics with ABN-AMRO Bank, London. IBAN: GB35 ABNA 4050 3040 2095 20. BIC: ABNAGB2L. Currency: sterling (UKP). Please ensure your full name and address gets communicated to us.

Cheque sent by post, made payable to Elektor Electronics. We can only accept sterling cheques and bank drafts from UK-resident customers or subscribers. We regret that no cheques can be accepted from customers or subscribers in any other country.

Giro transfer into account no. 34-152-3801, held by Elektor Electronics. Please do not send giro transfer/deposit forms directly to us, but instead use the National Giro postage paid envelope and send it to your National Giro Centre.

Credit card VISA and MasterCard can be processed by mail, email, web, fax and telephone. Online ordering through our website is SSL-protected for your security.

COMPONENTS

Components for projects appearing in Elektor are usually available from certain advertisers in this magazine. If difficulties in the supply of components are envisaged, a source will normally be advised in the article. Note, however, that the source(s) given is (are) not exclusive.

TERMS OF BUSINESS

Delivery Although every effort will be made to dispatch your order within 2-3 weeks from receipt of your instructions, we can not guarantee this time scale for all orders. **Returns** Faulty goods or goods sent in error may be returned for replacement or refund, but not before obtaining our consent. All goods returned should be packed securely in a padded bag or box, enclosing a covering letter stating the dispatch note number.

If the goods are returned because of a mistake on our part, we will refund the return postage. **Damaged goods** Claims for damaged goods must be received at our Brentford office within 10-days (UK); 14-days (Europe) or 21-days (all other countries). **Cancelled orders** All cancelled orders will be subject to a 10% handling charge with a minimum charge of £5.00. **Patents** Patent protection may exist in respect of circuits, devices, components, and so on, described in our books and magazines. Elektor does not accept responsibility or liability for failing to identify such patent or other protection. **Copyright** All drawings, photographs, articles, printed circuit boards, programmed integrated circuits, diskettes and software carriers published in our books and magazines (other than in third-party advertisements) are copyright and may not be reproduced or transmitted in any form or by any means, including photocopying and recording, in whole or in part, without the prior permission of Elektor in writing. Such written permission must also be obtained before any part of these publications is stored in a retrieval system of any nature.

Notwithstanding the above, printed-circuit boards may be produced for private and personal use without prior permission. **Limitation of liability** Elektor shall not be liable in contract, tort, or otherwise, for any loss or damage suffered by the purchaser whatsoever or howsoever arising out of, or in connexion with, the supply of goods or services by Elektor other than to supply goods as described or, at the option of Elektor, to refund the purchaser any money paid in respect of the goods. **Law** Any question relating to the supply of goods and services by Elektor shall be determined in all respects by the laws of England.

September 2007

SUBSCRIPTION RATES FOR ANNUAL SUBSCRIPTION

	Standard	Plus
United Kingdom	£41.90	£48.80
Surface Mail		
Rest of the World	£54.50	£61.40
USA & Canada	US\$ 95.50	US\$106.50
Airmail		
Rest of the World	£68.90	£75.80
USA & Canada	US\$120.00	US\$131.00

HOW TO PAY

Bank transfer into account no. 40209520 held by Elektor Electronics with ABN-AMRO Bank, London. IBAN: GB35 ABNA 4050 3040 2095 20. BIC: ABNAGB2L. Currency: sterling (UKP). Please ensure your full name and address gets communicated to us.

Cheque sent by post, made payable to Elektor Electronics. We can only accept sterling cheques and bank drafts from UK-resident customers or subscribers. We regret that no cheques can be accepted from customers or subscribers in any other country.

Giro transfer into account no. 34-152-3801, held by Elektor Electronics. Please do not send giro transfer/deposit forms directly to us, but instead use the National Giro postage paid envelope and send it to your National Giro Centre.

Credit card VISA and MasterCard can be processed by mail, email, web, fax and telephone. Online ordering through our website is SSL-protected for your security.

SUBSCRIPTION CONDITIONS

The standard subscription order period is twelve months. If a permanent change of address during the subscription period means that copies have to be despatched by a more expensive service, no extra charge will be made. Conversely, no refund will be made, nor expiry date extended, if a change of address allows the use of a cheaper service.

Student applications, which qualify for a 20% (twenty per cent) reduction in current rates, must be supported by evidence of student-ship signed by the head of the college, school or university faculty. A standard Student Subscription costs £33.50, a Student Subscription-Plus costs £40.40 (UK only).

Please note that new subscriptions take about four weeks from receipt of order to become effective.

Cancelled subscriptions will be subject to a charge of 25% (twenty-five per cent) of the full subscription price or £7.50, whichever is the higher, plus the cost of any issues already dispatched. Subscriptions cannot be cancelled after they have run for six months or more.

January 2007

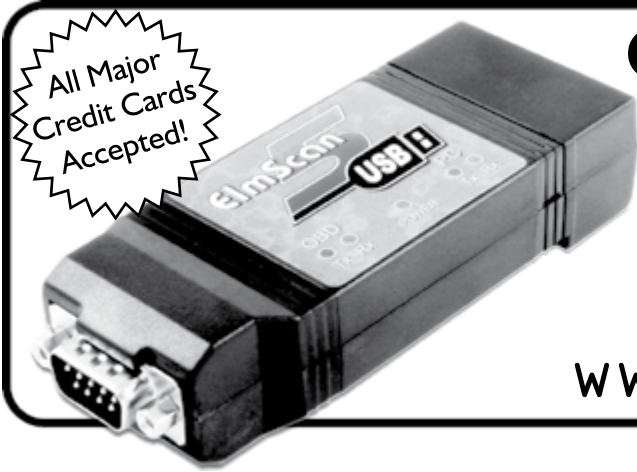

ElmScan 5 USB Scan Tool

- Diagnose any car with EOBD
- Based on the ELM327 IC
- Supports all EOBD and OBD-II protocols
 - ✓ ISO15765-4 (CAN)
 - ✓ ISO14230-4 (Keyword 2000)
 - ✓ ISO9141-2
 - ✓ J1850 VPW
 - ✓ J1850 PWM
- 9600 or 38400 baud
- Supported by more software than any other OBD interface
- Inexpensive
- Full Speed USB 1.1
- Automatic protocol detection
- Package includes cables, software CD, and Quick Start Guide
- Buy from your local UK distributors!

www.ElmScan5.com/elektor

Your price conscious PCB supplier



Online price calculation
Online ordering
Online order tracking
Online 24/24H and 7/7D

Interested? Contact us: +44 2088 167 005
E-mail: euro@eurocircuits.com

www.eurocircuits.com

Verified

- pooling for standard boards
- up to 6 layers
- from 1 to 1000 pieces
- from 3 working days onwards

A la carte

- pooling with more options
- up to 8 layers
- from 1 to 1000 pieces
- from 3 working days onwards

On demand

- your board, our challenge
- up to 16 layers
- from 1 piece onwards
- from 3 working days onwards

INDEX OF ADVERTISERS

Antex Electronics Ltd	www.antex.co.uk	45	MQP Electronics, Showcase	www.mqp.com	79
ATC Semitec Ltd, Showcase	www.atcsemitec.co.uk	78	New Wave Concepts, Showcase	www.new-wave-concepts.com	79
Avit Research, Showcase	www.avitresearch.co.uk	78	Newbury Electronics	www.newburyelectronics.co.uk	75
Beijing Draco	www.ezpcb.com	66	Number One Systems	www.numberone.com	14
Beta Layout, Showcase	www.pcb-pool.com	75, 78	Nurve Networks	www.xgamestation.com	75
Bitscope Designs	www.bitscope.com	33	Paltronix	www.paltronix.com	67
Bowood Electronics Ltd, Showcase	www.bowood-electronics.co.uk	78	SK Pang Electronics	www.skpang.co.uk	14
Byvac Electronics, Showcase	www.byvac.co.uk	78	Pico	www.picotech.com	75
Cleverscope	www.cleverscope.com	14	Quasar Electronics	www.quasarelectronics.com	74
Decibit Co. Ltd, Showcase	www.decibit.com	78	Robot Electronics, Showcase	www.robot-electronics.co.uk	79
EasyDAQ, Showcase	www.easydaq.biz	78	Robotiq, Showcase	www.robotiq.co.uk	79
Easysync, Showcase	www.easysync.co.uk	78	Scantool	www.ElmScan5.com/elektor	87
Eltec, Showcase	www.eltec.com	78	Showcase	78, 79	
Eurocircuits	www.eurocircuits.com	87	Texas Instruments	www.ti.com/portable-power-ekt-uk	3
First Technology Transfer Ltd, Showcase	www.ftt.co.uk	78	Tsien (UK) Ltd, Showcase	www.componentbin.com	66, 83
FlexiPanel Ltd, Showcase	www.flexipanel.com	78	Ultraleds, Showcase	www.ultraleds.co.uk	79
Future Technology Devices, Showcase	www.ftdichip.com	78	USB Instruments, Showcase	www.usb-instruments.com	79
Futurlec, Showcase	www.futurlec.com	78	Virtins Technology, Showcase	www.virtins.com	79
Jaycar Electronics	www.jaycarelectronics.co.uk	2			
Labcenter	www.labcenter.com	88			
Lektronix	www.lektronix.net	32			
London Electronics College, Showcase	www.lec.org.uk	78			
Marchand Electronics Inc, Showcase	www.marchandelec.com	78			
Microchip	www.microchip.com	15			
Mikro Elektronika	www.mikroe.com	21			
MJComponents	www.mjcomponents.com	66			

Advertising space for the issue of 17 December 2007

may be reserved not later than 20 November 2007

with Huson International Media – Cambridge House – Gogmore Lane – Chertsey, Surrey KT16 9AP – England – Telephone 01932 564 999 – Fax 01932 564998 – e-mail: gerryb@husonmedia.com to whom all correspondence, copy instructions and artwork should be addressed.

PROTEUS

DESIGN SUITE

COMPUTER ~~AIDED~~ DESIGN ENHANCED

- Powerful, Easy to Use Schematic Capture
- Interactive Mixed Mode SPICE Simulation
- Unique Microcontroller Co-Simulation and Debugging
- Fully Featured PCB Design and 3D Viewer

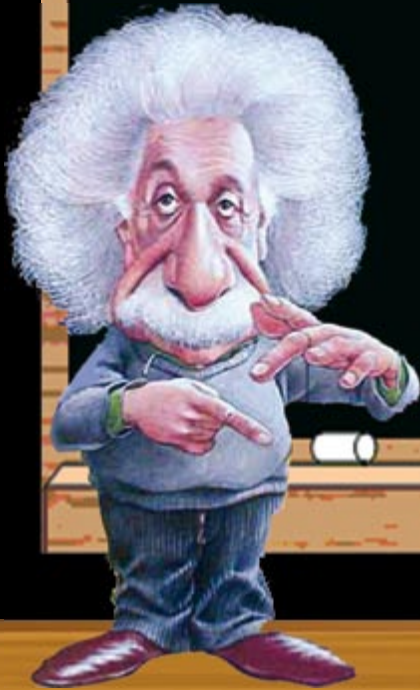
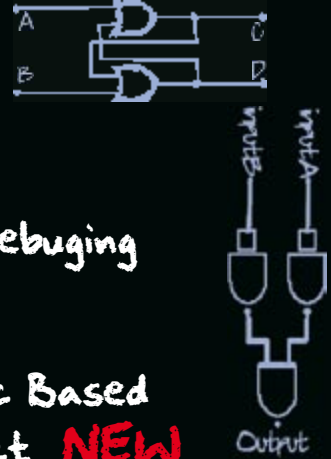

+

Worlds First Schematic Based
USB Simulation Product **NEW**

=

- Complete Engineering Solution
- Rapid Development Environment
- Maximum Return on Investment
- Faster Time to Market



AUTUMN SPECIAL OFFER

20% off all new orders for the Proteus Design Suite when you spend £400 or more.

Electronic Design from Concept To Completion

LABCENTER ELECTRONICS LTD

A technology Pioneer in the EDA industry since 1988.
Technical support direct from the program authors.
Flexible packages and pricing tailored to customer requirements.

CONTACT US NOW

to discuss your requirements or
request a FREE evaluation copy.

labcenter  www.labcenter.com
Electronics

TEL: +44 (0)1756 753440
FAX: +44 (0)1756 752857
Email: info@labcenter.com

Labcenter Electronics Ltd., 53-55 Main Street, Grassington
North Yorks, BD23 5AA. Registered in England 4692454