

# XYZs of Oscilloscopes

Primer

## Table of Contents

<b>Introduction</b> .....	<b>4</b>
<b>Signal Integrity</b> .....	<b>5 - 6</b>
The Significance of Signal Integrity .....	5
Why is Signal Integrity a Problem? .....	5
Viewing the Analog Origins of Digital Signals .....	6
<b>The Oscilloscope</b> .....	<b>7 - 12</b>
Understanding Waveforms & Waveform Measurements ..	7
Types of Waves .....	8
Sine Waves .....	9
Square and Rectangular Waves .....	9
Sawtooth and Triangle Waves .....	9
Step and Pulse Shapes .....	9
Periodic and Non-periodic Signals .....	9
Synchronous and Asynchronous Signals .....	9
Complex Waves .....	10
Waveform Measurements .....	11
Frequency and Period .....	11
Voltage .....	11
Amplitude .....	11
Phase .....	11
Waveform Measurements with Digital Oscilloscopes	12
<b>Types of Oscilloscopes</b> .....	<b>13 - 17</b>
Digital Storage Oscilloscopes .....	13
Digital Phosphor Oscilloscopes .....	15
Mixed Signal Oscilloscopes .....	16
Digital Sampling Oscilloscopes .....	17

## The Systems and Controls of an Oscilloscope .18 - 31

Vertical System and Controls .....	19
Position and Volts per Division .....	19
Input Coupling .....	19
Bandwidth Limit .....	19
Bandwidth Enhancement .....	20
Horizontal System and Controls .....	20
Acquisition Controls .....	20
Acquisition Modes .....	20
Types of Acquisition Modes .....	21
Starting and Stopping the Acquisition System ....	21
Sampling .....	22
Sampling Controls .....	22
Real-time Sampling Method .....	22
Equivalent-time Sampling Method .....	24
Position and Seconds per Division .....	26
Time Base Selections .....	26
Zoom/Pan .....	26
Search .....	26
XY Mode .....	26
Z Axis .....	26
XYZ Mode .....	26
Trigger System and Controls .....	27
Trigger Position .....	29
Trigger Level and Slope .....	29
Trigger Sources .....	29
Trigger Modes .....	30
Trigger Coupling .....	30
Trigger Holdoff .....	30
Display System and Controls .....	31
Other Oscilloscope Controls .....	31
Math and Measurement Operations .....	31
Digital Timing and State Acquisitions .....	31

<b>The Complete Measurement System . . . . .</b>	<b>32 - 34</b>	<b>Operating the Oscilloscope . . . . .</b>	<b>43 - 45</b>
Probes . . . . .	32	Proper Grounding . . . . .	43
Passive Probes . . . . .	33	Setting the Controls . . . . .	43
Active and Differential Probes . . . . .	34	Calibrating the Instrument . . . . .	44
Logic Probes . . . . .	34	Connecting the Probes . . . . .	44
Specialty Probes . . . . .	35	Compensating the Probes . . . . .	44
Probe Accessories . . . . .	35	<b>Oscilloscope Measurement Techniques . . . . .</b>	<b>46 - 48</b>
<b>Performance Terms and Considerations . . . . .</b>	<b>35 - 42</b>	Voltage Measurements . . . . .	46
Bandwidth . . . . .	35	Time and Frequency Measurements . . . . .	47
Rise Time . . . . .	36	Pulse Width and Rise Time Measurements . . . . .	47
Sample Rate . . . . .	37	Phase Shift Measurements . . . . .	48
Waveform Capture Rate . . . . .	38	Other Measurement Techniques . . . . .	48
Record Length . . . . .	38	<b>Written Exercises . . . . .</b>	<b>49 - 54</b>
Triggering Capabilities . . . . .	39	Part I	
Effective Bits . . . . .	39	A. Vocabulary Exercises . . . . .	49
Frequency Response . . . . .	39	B. Application Exercises . . . . .	50
Vertical Sensitivity . . . . .	39	Part II	
Sweep Speed . . . . .	39	A. Vocabulary Exercises . . . . .	51
Gain Accuracy . . . . .	39	B. Application Exercises . . . . .	52
Horizontal Accuracy (Time Base) . . . . .	39	Answer Key . . . . .	54
Vertical Resolution (Analog-to-Digital Converter) . . . . .	39	<b>Glossary . . . . .</b>	<b>55 - 58</b>
Timing Resolution (MSO) . . . . .	40		
Connectivity . . . . .	40		
Expandability . . . . .	40		
Ease-of-use . . . . .	42		

## Introduction

Nature moves in the form of a sine wave, be it an ocean wave, earthquake, sonic boom, explosion, sound through air, or the natural frequency of a body in motion. Energy, vibrating particles and other invisible forces pervade our physical universe. Even light – part particle, part wave – has a fundamental frequency, which can be observed as color.

Sensors can convert these forces into electrical signals that you can observe and study with an oscilloscope. Oscilloscopes enable scientists, engineers, technicians, educators and others to “see” events that change over time.

Oscilloscopes are indispensable tools for anyone designing, manufacturing or repairing electronic equipment. In today’s fast-paced world, engineers need the best tools available to solve their measurement challenges quickly and accurately. As the eyes of the engineer, oscilloscopes are the key to meeting today’s demanding measurement challenges.

The usefulness of an oscilloscope is not limited to the world of electronics. With the proper sensor, an oscilloscope can measure all kinds of phenomena. A sensor is a device that creates an electrical signal in response to physical stimuli, such as sound, mechanical stress, pressure, light, or heat. A microphone is a sensor that converts sound into an electrical signal. Figure 1 shows an example of scientific data that can be gathered by an oscilloscope.

Oscilloscopes are used by everyone from physicists to repair technicians. An automotive engineer uses an oscilloscope to correlate analog data from sensors with serial data from the engine control unit. A medical researcher uses an oscilloscope to measure brain waves. The possibilities are endless.

The concepts presented in this primer will provide you with a good starting point in understanding oscilloscope basics and operation.

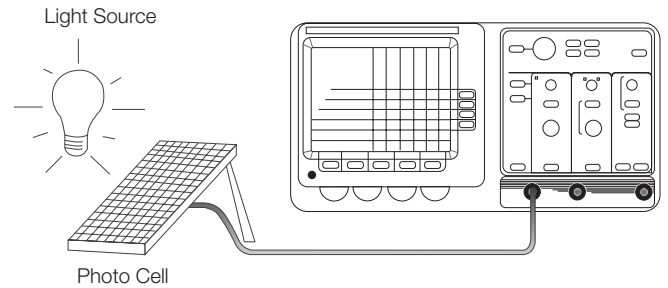

**Figure 1.** An example of scientific data gathered by an oscilloscope.

The glossary in the back of this primer will give you definitions of unfamiliar terms. The vocabulary and multiple-choice written exercises on oscilloscope theory and controls make this primer a useful classroom aid. No mathematical or electronics knowledge is necessary.

After reading this primer, you will be able to:

- Describe how oscilloscopes work
- Describe the differences between various oscilloscopes
- Describe electrical waveform types
- Understand basic oscilloscope controls
- Take simple measurements

The manual provided with your oscilloscope will give you more specific information about how to use the oscilloscope in your work. Some oscilloscope manufacturers also provide a multitude of application notes to help you optimize the oscilloscope for your application-specific measurements.

Should you need additional assistance, or have any comments or questions about the material in this primer, simply contact your Tektronix representative, or visit [www.tektronix.com](http://www.tektronix.com).

# Signal Integrity

## The Significance of Signal Integrity

The key to any good oscilloscope system is its ability to accurately reconstruct a waveform – referred to as signal integrity. An oscilloscope is analogous to a camera that captures signal images that we can then observe and interpret. Two key issues lie at the heart of signal integrity.

- When you take a picture, is it an accurate picture of what actually happened?
- Is the picture clear or fuzzy?
- How many of those accurate pictures can you take per second?

Taken together, the different systems and performance capabilities of an oscilloscope contribute to its ability to deliver the highest signal integrity possible. Probes also affect the signal integrity of a measurement system.

Signal integrity impacts many electronic design disciplines. But until a few years ago, it wasn't much of a problem for digital designers. They could rely on their logic designs to act like the Boolean circuits they were. Noisy, indeterminate signals were something that occurred in high-speed designs – something for RF designers to worry about. Digital systems switched slowly and signals stabilized predictably.

Processor clock rates have since multiplied by orders of magnitude. Computer applications such as 3D graphics, video and server I/O demand vast bandwidth. Much of today's telecommunications equipment is digitally based, and similarly requires massive bandwidth. So too does digital high-definition TV. The current crop of microprocessor devices handles data at rates up to 2, 3 and even 5 GS/s (gigasamples per second), while some DDR3 memory devices use clocks in excess of 2 GHz as well as data signals with 35 ps rise times.

Importantly, speed increases have trickled down to the common IC devices used in automobiles, consumer electronics, and machine controllers, to name just a few applications.

A processor running at a 20 MHz clock rate may well have signals with rise times similar to those of an 800 MHz processor. Designers have crossed a performance threshold that means, in effect, almost every design is a high-speed design.

Without some precautionary measures, high-speed problems can creep into otherwise conventional digital designs. If a circuit is experiencing intermittent failures, or if it encounters errors at voltage and temperature extremes, chances are there are some hidden signal integrity problems. These can affect time-to-market, product reliability, EMI compliance, and more. These high-speed problems can also impact the integrity of a serial data stream in a system, requiring some method of correlating specific patterns in the data with the observed characteristics of high-speed waveforms.

## Why is Signal Integrity a Problem?

Let's look at some of the specific causes of signal degradation in today's digital designs. Why are these problems so much more prevalent today than in years past?

The answer is speed. In the "slow old days," maintaining acceptable digital signal integrity meant paying attention to details like clock distribution, signal path design, noise margins, loading effects, transmission line effects, bus termination, decoupling and power distribution. All of these rules still apply, but...

Bus cycle times are up to a thousand times faster than they were 20 years ago! Transactions that once took microseconds are now measured in nanoseconds. To achieve this improvement, edge speeds too have accelerated: they are up to 100 times faster than those of two decades ago.

This is all well and good; however, certain physical realities have kept circuit board technology from keeping up the pace. The propagation time of inter-chip buses has remained almost unchanged over the decades. Geometries have shrunk, certainly, but there is still a need to provide circuit board real estate for IC devices, connectors, passive components, and of course, the bus traces themselves. This real estate adds up to distance, and distance means time – the enemy of speed.

It's important to remember that the edge speed – rise time – of a digital signal can carry much higher frequency components than its repetition rate might imply. For this reason, some designers deliberately seek IC devices with relatively “slow” rise times.

The lumped circuit model has always been the basis of most calculations used to predict signal behavior in a circuit. But when edge speeds are more than four to six times faster than the signal path delay, the simple lumped model no longer applies.

Circuit board traces just six inches long become transmission lines when driven with signals exhibiting edge rates below four to six nanoseconds, irrespective of the cycle rate. In effect, new signal paths are created. These intangible connections aren't on the schematics, but nevertheless provide a means for signals to influence one another in unpredictable ways.

Sometimes even the errors introduced by the probe/instrument combination can provide a significant contribution to the signal being measured. However, by applying the “square root of the sum of the squares” formula to the measured value, it is possible to determine whether the device under test is approaching a rise/fall time failure. In addition, recent oscilloscope tools use special filtering techniques to de-embed the measurement system's effects on the signal, displaying edge times and other signal characteristics.

At the same time, the intended signal paths don't work the way they are supposed to. Ground planes and power planes, like the signal traces described above, become inductive and act like transmission lines; power supply decoupling is far less effective. EMI goes up as faster edge speeds produce shorter wavelengths relative to the bus length. Crosstalk increases.

In addition, fast edge speeds require generally higher currents to produce them. Higher currents tend to cause ground bounce, especially on wide buses in which many signals switch at once. Moreover, higher current increases the amount of radiated magnetic energy and with it, crosstalk.

### Viewing the Analog Origins of Digital Signals

What do all these characteristics have in common? They are classic analog phenomena. To solve signal integrity problems, digital designers need to step into the analog domain. And to take that step, they need tools that can show them how digital and analog signals interact.

Digital errors often have their roots in analog signal integrity problems. To track down the cause of the digital fault, it's often necessary to turn to an oscilloscope, which can display waveform details, edges and noise; can detect and display transients; and can help you precisely measure timing relationships such as setup and hold times. Modern oscilloscopes can help to simplify the troubleshooting process by triggering on specific patterns in parallel or serial data streams and displaying the analog signal that corresponds in time with a specified event.

Understanding each of the systems within your oscilloscope and how to apply them will contribute to the effective application of the oscilloscope to tackle your specific measurement challenge.

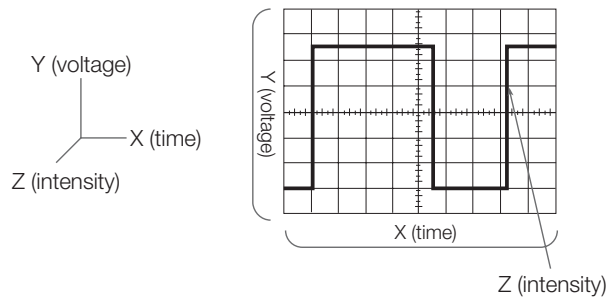

Figure 2. X, Y, and Z components of a displayed waveform.

## The Oscilloscope

What is an oscilloscope and how does it work? This section answers these fundamental questions.

The oscilloscope is basically a graph-displaying device – it draws a graph of an electrical signal. In most applications, the graph shows how signals change over time: the vertical (Y) axis represents voltage and the horizontal (X) axis represents time. The intensity or brightness of the display is sometimes called the Z axis, as shown in Figure 2. In DPO oscilloscopes, the Z axis can be represented by color grading of the display, as seen in Figure 3.

This simple graph can tell you many things about a signal, such as:

- The time and voltage values of a signal
- The frequency of an oscillating signal
- The “moving parts” of a circuit represented by the signal
- The frequency with which a particular portion of the signal is occurring relative to other portions
- Whether or not a malfunctioning component is distorting the signal
- How much of a signal is direct current (DC) or alternating current (AC)
- How much of the signal is noise and whether the noise is changing with time

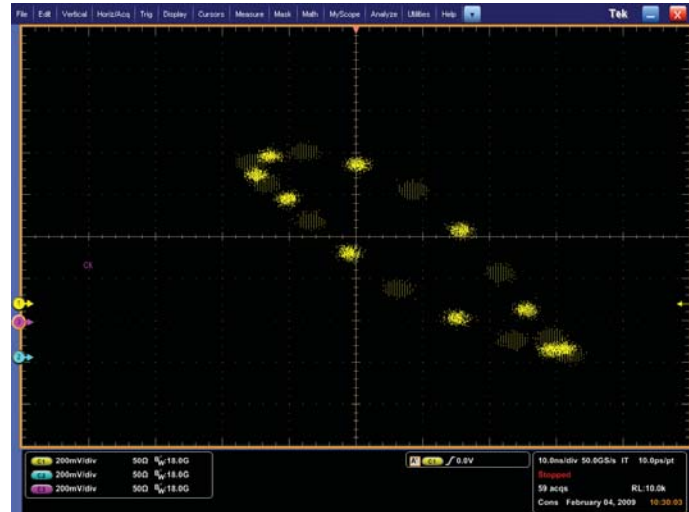

Figure 3. Two offset clock patterns with Z axis intensity grading.

## Understanding Waveforms and Waveform Measurements

The generic term for a pattern that repeats over time is a wave – sound waves, brain waves, ocean waves, and voltage waves are all repetitive patterns. An oscilloscope measures voltage waves. Remember as mentioned earlier, that physical phenomena such as vibrations or temperature or electrical phenomena such as current or power can be converted to a voltage by a sensor. One cycle of a wave is the portion of the wave that repeats. A waveform is a graphic representation of a wave. A voltage waveform shows time on the horizontal axis and voltage on the vertical axis.

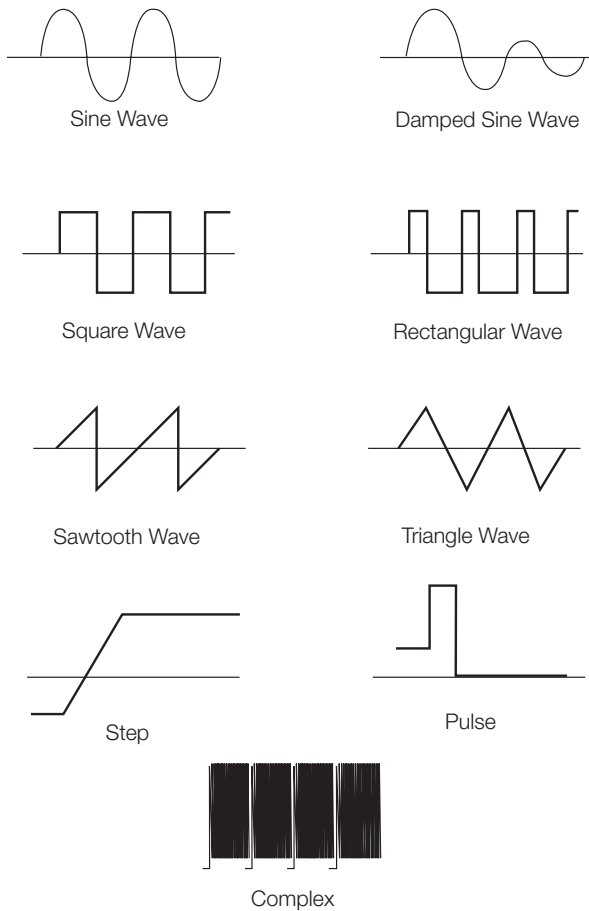

Figure 4. Common waveforms.

Waveform shapes reveal a great deal about a signal. Any time you see a change in the height of the waveform, you know the voltage has changed. Any time there is a flat horizontal line, you know that there is no change for that length of time. Straight, diagonal lines mean a linear change – rise or fall of voltage at a steady rate. Sharp angles on a waveform indicate sudden change. Figure 4 shows common waveforms and Figure 5 displays sources of common waveforms.

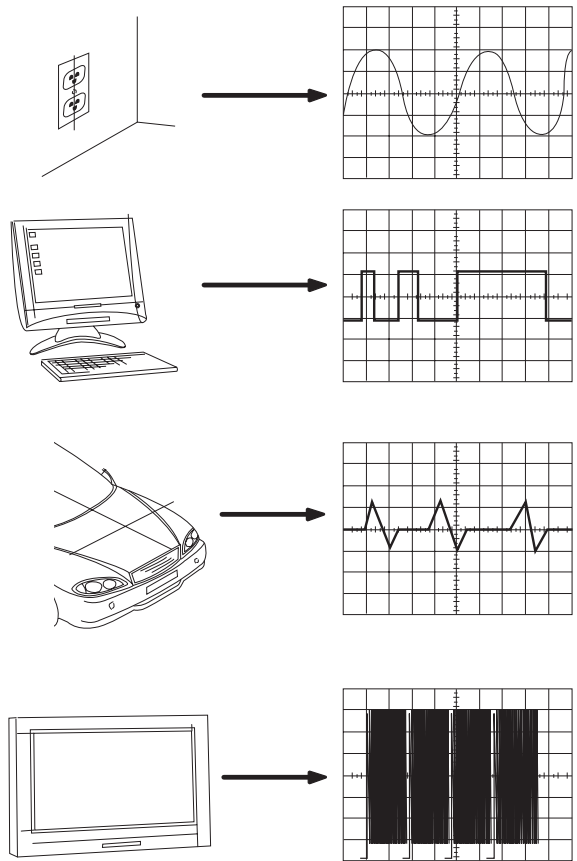

Figure 5. Sources of common waveforms.

## Types of Waves

You can classify most waves into these types:

- Sine waves
- Square and rectangular waves
- Sawtooth and triangle waves
- Step and pulse shapes
- Periodic and non-periodic signals
- Synchronous and asynchronous signals
- Complex waves



## Sine Waves

The sine wave is the fundamental wave shape for several reasons. It has harmonious mathematical properties – it is the same sine shape you may have studied in trigonometry class. The voltage in your wall outlet varies as a sine wave. Test signals produced by the oscillator circuit of a signal generator are often sine waves. Most AC power sources produce sine waves. (AC signifies alternating current, although the voltage alternates too. DC stands for direct current, which means a steady current and voltage, such as a battery produces.)

The damped sine wave is a special case you may see in a circuit that oscillates, but winds down over time.

## Square and Rectangular Waves

The square wave is another common wave shape. Basically, a square wave is a voltage that turns on and off (or goes high and low) at regular intervals. It is a standard wave for testing amplifiers – good amplifiers increase the amplitude of a square wave with minimum distortion. Television, radio and computer circuitry often use square waves for timing signals.

The rectangular wave is like the square wave except that the high and low time intervals are not of equal length. It is particularly important when analyzing digital circuitry.

## Sawtooth and Triangle Waves

Sawtooth and triangle waves result from circuits designed to control voltages linearly, such as the horizontal sweep of an analog oscilloscope or the raster scan of a television. The transitions between voltage levels of these waves change at a constant rate. These transitions are called ramps.

## Step and Pulse Shapes

Signals such as steps and pulses that occur rarely, or non-periodically, are called single-shot or transient signals. A step indicates a sudden change in voltage, similar to the voltage change you would see if you turned on a power switch.

A pulse indicates sudden changes in voltage, similar to the voltage changes you would see if you turned a power switch on and then off again. A pulse might represent one bit of information traveling through a computer circuit or it might be a glitch, or defect, in a circuit. A collection of pulses traveling together creates a pulse train. Digital components in a computer communicate with each other using pulses. These pulses may be in the form of serial data stream or multiple signal lines may be used to represent a value in a parallel data bus. Pulses are also common in x-ray, radar, and communications equipment.

## Periodic and Non-periodic Signals

Repetitive signals are referred to as periodic signals, while signals that constantly change are known as non-periodic signals. A still picture is analogous to a periodic signal, while a moving picture can be equated to a non-periodic signal.

## Synchronous and Asynchronous Signals

When a timing relationship exists between two signals, those signals are referred to as synchronous. Clock, data and address signals inside a computer are an example of synchronous signals.

Asynchronous is a term used to describe those signals between which no timing relationship exists. Because no time correlation exists between the act of touching a key on a computer keyboard and the clock inside the computer, these are considered asynchronous.



Figure 6. An NTSC composite video signal is an example of a complex wave.

### Complex Waves

Some waveforms combine the characteristics of sines, squares, steps, and pulses to produce complex waveshapes. The signal information may be embedded in the form of amplitude, phase, and/or frequency variations. For example, although the signal in Figure 6 is an ordinary composite video signal, it is composed of many cycles of higher-frequency waveforms embedded in a lower-frequency envelope.

In this example, it is usually most important to understand the relative levels and timing relationships of the steps. To view this signal, you need an oscilloscope that captures the low-frequency envelope and blends in the higher-frequency waves in an intensity-graded fashion so that you can see their overall combination as an image that can be visually interpreted. Digital phosphor oscilloscopes are most suited to viewing complex waves, such as video signals, illustrated in Figure 6. Their displays provide the necessary frequency-of-occurrence information, or intensity grading, that is essential to understanding what the waveform is really doing.

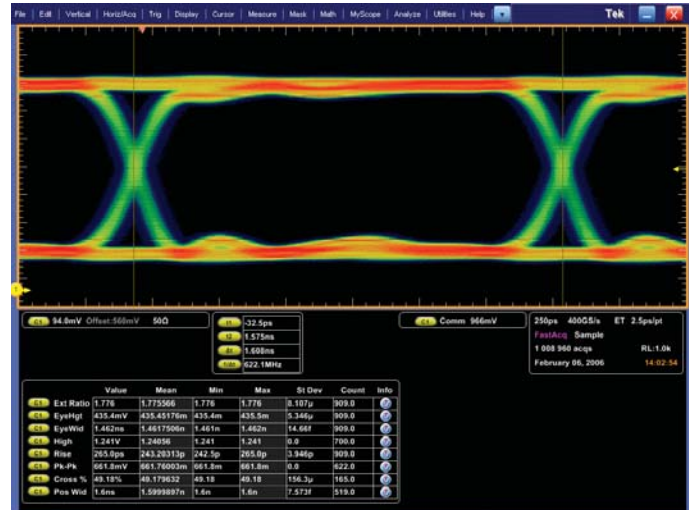

Figure 7. 622 Mb/s serial data eye pattern.

Some oscilloscopes allow for displaying certain types of complex waveforms in special ways. For example, telecommunications data may be displayed as an eye pattern or a constellation diagram.

Telecommunications digital data signals can be displayed on an oscilloscope as a special type of waveform referred to as an eye pattern. The name comes from the similarity of the waveform to a series of eyes, as seen in Figure 7. Eye patterns are produced when digital data from a receiver is sampled and applied to the vertical input, while the data rate is used to trigger the horizontal sweep. The eye pattern displays one bit or unit interval of data with all possible edge transitions and states superimposed in one comprehensive view.

A constellation diagram is a representation of a signal modulated by a digital modulation scheme such as quadrature amplitude modulation or phase-shift keying.

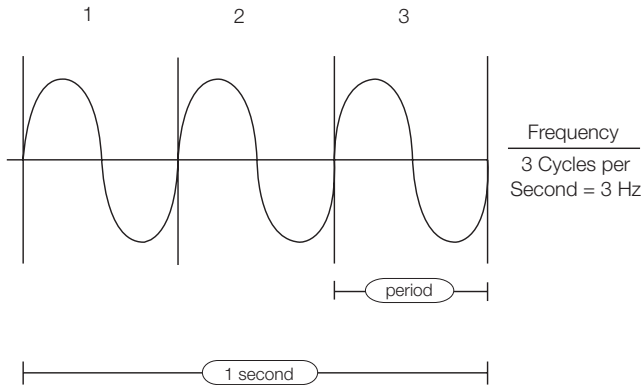

Figure 8. Frequency and period of a sine wave.

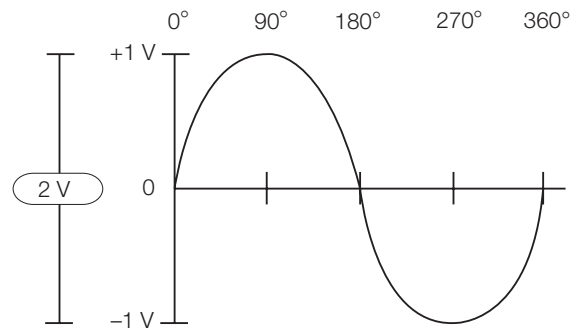

Figure 9. Amplitude and degrees of a sine wave.

## Waveform Measurements

Many terms are used to describe the types of measurements that you make with your oscilloscope. This section describes some of the most common measurements and terms.

### Frequency and Period

If a signal repeats, it has a frequency. The frequency is measured in Hertz (Hz) and equals the number of times the signal repeats itself in one second, referred to as cycles per second. A repetitive signal also has a period, which is the amount of time it takes the signal to complete one cycle. Period and frequency are reciprocals of each other, so that  $1/\text{period}$  equals the frequency and  $1/\text{frequency}$  equals the period. For example, the sine wave in Figure 8 has a frequency of 3 Hz and a period of  $1/3$  second.

### Voltage

Voltage is the amount of electric potential, or signal strength, between two points in a circuit. Usually, one of these points is ground, or zero volts, but not always. You may want to measure the voltage from the maximum peak to the minimum peak of a waveform, referred to as the peak-to-peak voltage.

### Amplitude

Amplitude refers to the amount of voltage between two points in a circuit. Amplitude commonly refers to the maximum voltage of a signal measured from ground, or zero volts. The waveform shown in Figure 9 has an amplitude of 1 V and a peak-to-peak voltage of 2 V.

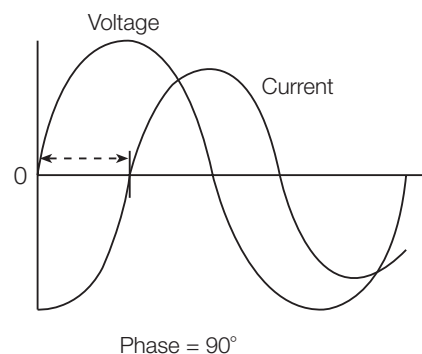

Figure 10. Phase shift.

### Phase

**Phase** is best explained by looking at a sine wave. The voltage level of sine waves is based on circular motion. Given that a circle has 360°, one cycle of a sine wave has 360°, as shown in Figure 9. Using degrees, you can refer to the phase angle of a sine wave when you want to describe how much of the period has elapsed.

Phase shift describes the difference in timing between two otherwise similar signals. The waveform in Figure 10 labeled “current” is said to be 90° out of phase with the waveform labeled “voltage,” since the waves reach similar points in their cycles exactly  $1/4$  of a cycle apart ( $360^\circ/4 = 90^\circ$ ). Phase shifts are common in electronics.

## Waveform Measurements with Digital Oscilloscopes

Modern digital oscilloscopes have functions that make waveform measurements easier. They have front-panel buttons and/or screen-based menus from which you can select fully automated measurements. These include amplitude, period, rise/fall time, and many more. Many digital instruments also provide mean and RMS calculations, duty cycle, and other math operations. Automated measurements appear as on-screen alphanumeric readouts. Typically these readings are more accurate than is possible to obtain with direct graticule interpretation.

### Examples of fully automated waveform measurements:

- Period
- Frequency
- Width +
- Width -
- Rise time
- Fall time
- Amplitude
- Extinction ratio
- Mean optical power
- Duty Cycle +
- Duty Cycle -
- Delay
- Phase
- Burst width
- Peak-to-peak
- Mean
- Cycle mean
- Cycle area
- High
- Low
- Minimum
- Maximum
- Overshoot +
- Overshoot -
- RMS
- Cycle RMS
- Jitter

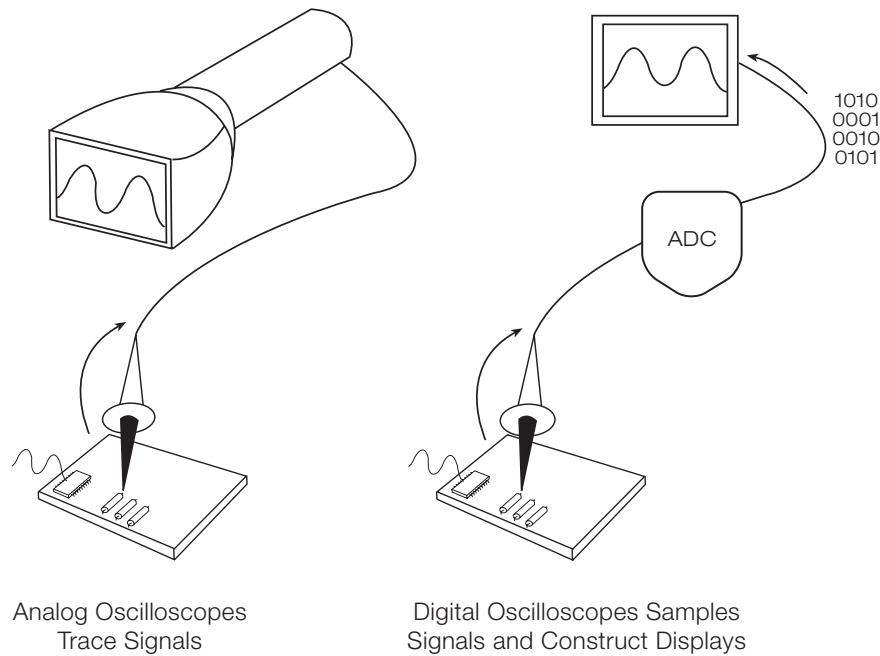

**Figure 11.** Analog oscilloscopes trace signals, while digital oscilloscopes sample signals and construct displays.

## The Types of Oscilloscopes

Electronic equipment can be classified into two categories: analog and digital. Analog equipment works with continuously variable voltages, while digital equipment works with discrete binary numbers that represent voltage samples. A conventional phonograph is an analog device, while a compact disc player is a digital device.

Oscilloscopes can be classified similarly – as analog and digital types. In contrast to an analog oscilloscope, a digital oscilloscope uses an analog-to-digital converter (ADC) to convert the measured voltage into digital information. It acquires the waveform as a series of samples, and stores these samples until it accumulates enough samples to describe a waveform. The digital oscilloscope then re-assembles the waveform for display on the screen, as seen in Figure 11.

Digital oscilloscopes can be classified into digital storage oscilloscopes (DSOs), digital phosphor oscilloscopes (DPOs), mixed signal oscilloscopes (MSOs), and digital sampling oscilloscopes.

The digital approach means that the oscilloscope can display any frequency within its range with stability, brightness, and clarity. For repetitive signals, the bandwidth of the digital oscilloscope is a function of the analog bandwidth of the

front-end components of the oscilloscope, commonly referred to as the  $-3$  dB point. For single-shot and transient events, such as pulses and steps, the bandwidth can be limited by the oscilloscope's sample rate. Please refer to the Sample Rate section under Performance Terms and Considerations for a more detailed discussion.

### Digital Storage Oscilloscopes

A conventional digital oscilloscope is known as a digital storage oscilloscope (DSO). Its display typically relies on a raster-type screen rather than the luminous phosphor found in an older analog oscilloscope.

Digital storage oscilloscopes (DSOs) allow you to capture and view events that may happen only once – known as transients. Because the waveform information exists in digital form as a series of stored binary values, it can be analyzed, archived, printed, and otherwise processed, within the oscilloscope itself or by an external computer. The waveform need not be continuous; it can be displayed even when the signal disappears. Unlike analog oscilloscopes, digital storage oscilloscopes provide permanent signal storage and extensive waveform processing. However, DSOs typically have no real-time intensity grading; therefore, they cannot express varying levels of intensity in the live signal.

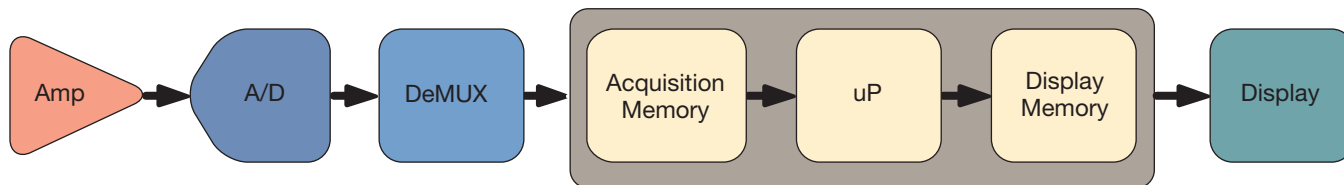

Figure 12. The serial-processing architecture of a digital storage oscilloscope (DSO).

Some of the subsystems that comprise DSOs are similar to those in analog oscilloscopes. However, DSOs contain additional data-processing subsystems that are used to collect and display data for the entire waveform. A DSO employs a serial-processing architecture to capture and display a signal on its screen, as shown in Figure 12. A description of this serial-processing architecture follows.

### Serial-processing Architecture

Like an analog oscilloscope, a DSO's first (input) stage is a vertical amplifier. Vertical controls allow you to adjust the amplitude and position range at this stage. Next, the analog-to-digital converter (ADC) in the horizontal system samples the signal at discrete points in time and converts the signal's voltage at these points into digital values called sample points. This process is referred to as digitizing a signal.

The horizontal system's sample clock determines how often the ADC takes a sample. This rate is referred to as the sample rate and is expressed in samples per second (S/s).

The sample points from the ADC are stored in acquisition memory as waveform points. Several sample points may comprise one waveform point. Together, the waveform points comprise one waveform record. The number of waveform points used to create a waveform record is called the record length. The trigger system determines the start and stop points of the record.

The DSO's signal path includes a microprocessor through which the measured signal passes on its way to the display. This microprocessor processes the signal, coordinates display activities, manages the front panel controls, and more. The signal then passes through the display memory and is displayed on the oscilloscope screen.

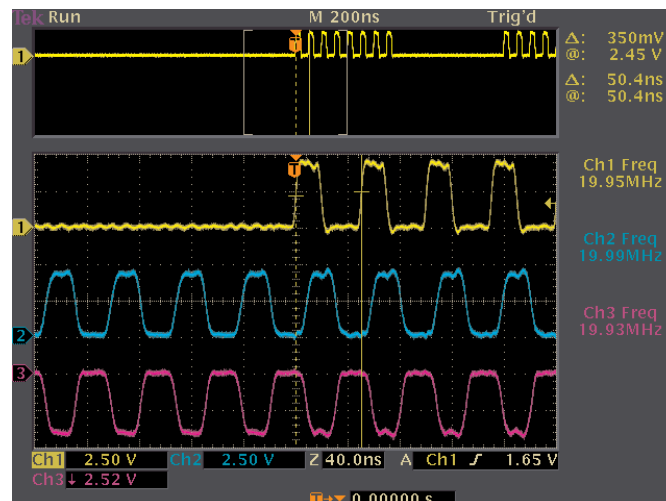

Figure 13. The digital storage oscilloscope delivers high-speed, single-shot acquisition across multiple channels, increasing the likelihood of capturing elusive glitches and transient events.

Depending on the capabilities of your oscilloscope, additional processing of the sample points may take place, which enhances the display. Pre-trigger may also be available, enabling you to see events before the trigger point. Most of today's digital oscilloscopes also provide a selection of automatic parametric measurements, simplifying the measurement process.

As shown in Figure 13, a DSO provides high performance in a single-shot, multi-channel instrument. DSOs are ideal for low-repetition-rate or single-shot, high-speed, multi-channel design applications. In the real world of digital design, an engineer usually examines four or more signals simultaneously, making the DSO a critical companion.

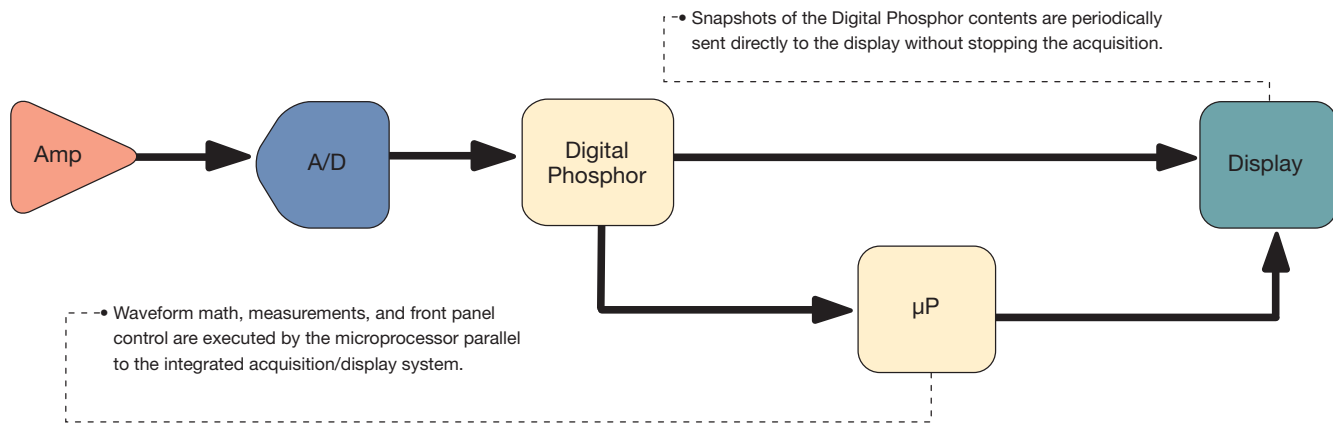

Figure 14. The parallel-processing architecture of a digital phosphor oscilloscope (DPO).

## Digital Phosphor Oscilloscopes

The digital phosphor oscilloscope (DPO) offers a new approach to oscilloscope architecture. This architecture enables a DPO to deliver unique acquisition and display capabilities to accurately reconstruct a signal.

While a DSO uses a serial-processing architecture to capture, display and analyze signals, a DPO employs a parallel-processing architecture to perform these functions, as shown in Figure 14. The DPO architecture dedicates unique ASIC hardware to acquire waveform images, delivering high waveform capture rates that result in a higher level of signal visualization. This performance increases the probability of witnessing transient events that occur in digital systems, such as runt pulses, glitches and transition errors, and enables additional analysis capability. A description of this parallel-processing architecture follows.

### Parallel-processing Architecture

A DPO's first (input) stage is similar to that of an analog oscilloscope – a vertical amplifier – and its second stage is similar to that of a DSO – an ADC. But, the DPO differs significantly from its predecessors following the analog-to-digital conversion.

For any oscilloscope – analog, DSO or DPO – there is always a holdoff time during which the instrument processes the most recently acquired data, resets the system, and waits for the next trigger event. During this time, the oscilloscope is blind to all signal activity. The probability of seeing an infrequent or low-repetition event decreases as the holdoff time increases.

It should be noted that it is impossible to determine the probability of capture by simply looking at the display update rate. If you rely solely on the update rate, it is easy to make the mistake of believing that the oscilloscope is capturing all pertinent information about the waveform when, in fact, it is not.

The digital storage oscilloscope processes captured waveforms serially. The speed of its microprocessor is a bottleneck in this process because it limits the waveform capture rate.

The DPO rasterizes the digitized waveform data into a digital phosphor database. Every 1/30th of a second – about as fast as the human eye can perceive it – a snapshot of the signal image that is stored in the database is pipelined directly to the display system. This direct rasterization of waveform data, and direct copy to display memory from the database, removes the data-processing bottleneck inherent in other architectures. The result is an enhanced “real-time” and lively display update. Signal details, intermittent events, and dynamic characteristics of the signal are captured in real-time. The DPO's microprocessor works in parallel with this integrated acquisition system for display management, measurement automation and instrument control, so that it does not affect the oscilloscope's acquisition speed.

A DPO faithfully emulates the best display attributes of an analog oscilloscope, displaying the signal in three dimensions: time, amplitude and the distribution of amplitude over time, all in real-time.

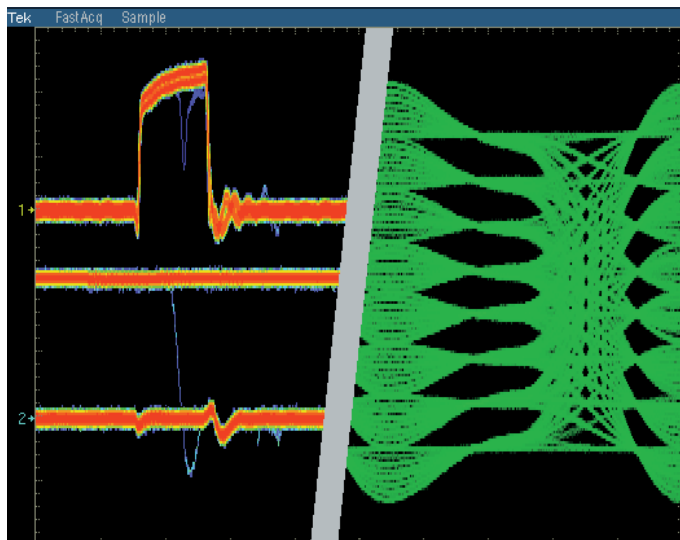
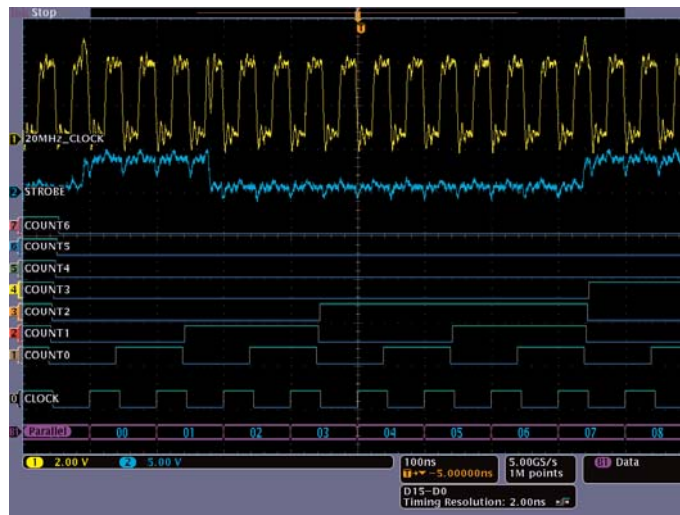

**Figure 15.** Some DPOs can acquire millions of waveform in just seconds, significantly increasing the probability of capturing intermittent and elusive events and revealing dynamic signal behavior.

Unlike an analog oscilloscope's reliance on chemical phosphor, a DPO uses a purely electronic digital phosphor that's actually a continuously updated database. This database has a separate "cell" of information for every single pixel in the oscilloscope's display. Each time a waveform is captured – in other words, every time the oscilloscope triggers – it is mapped into the digital phosphor database's cells. Each cell that represents a screen location and is touched by the waveform is reinforced with intensity information, while other cells are not. Thus, intensity information builds up in cells where the waveform passes most often.

When the digital phosphor database is fed to the oscilloscope's display, the display reveals intensified waveform areas, in proportion to the signal's frequency of occurrence at each point – much like the intensity grading characteristics of an analog oscilloscope. The DPO also allows the display of the varying frequency-of-occurrence information on the display as contrasting colors, unlike an analog oscilloscope. With a DPO, it is easy to see the difference between a waveform that occurs on almost every trigger and one that occurs, say, every 100th trigger.

Digital phosphor oscilloscopes (DPOs) break down the barrier between analog and digital oscilloscope technologies. They are equally suitable for viewing high and low frequencies, repetitive waveforms, transients, and signal variations in real-time. Only a DPO provides the Z (intensity) axis in real-time that is missing from conventional DSOs.



**Figure 16.** The MSO provides 16 integrated digital channels, enabling the ability to view and analyze time-correlated analog and digital signals.

A DPO is ideal for those who need the best general-purpose design and troubleshooting tool for a wide range of applications, as seen in Figure 15. A DPO is exemplary for advanced analysis, communication mask testing, digital debug of intermittent signals, repetitive digital design and timing applications.

## Mixed Signal Oscilloscopes

The mixed signal oscilloscope (MSO) combines the performance of a DPO with the basic functionality of a 16-channel logic analyzer, including parallel/serial bus protocol decoding and triggering. The MSO's digital channels view a digital signal as either a logic high or logic low, just like a digital circuit views the signal. This means as long as ringing, overshoot and ground bounce do not cause logic transitions, these analog characteristics are not of concern to the MSO. Just like a logic analyzer, a MSO uses a threshold voltage to determine if the signal is logic high or logic low.

The MSO is the tool of choice for quickly debugging digital circuits using its powerful digital triggering, high resolution acquisition capability, and analysis tools. The root cause of many digital problems is quicker to pinpoint by analyzing both the analog and digital representations of the signal, as shown in Figure 16, making a MSO ideal for verifying and debugging digital circuits.



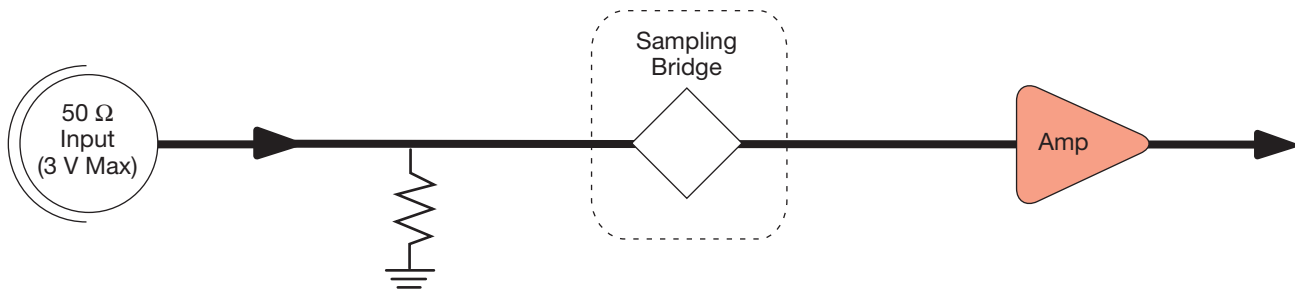

Figure 17. The architecture of a digital sampling oscilloscope.

## Digital Sampling Oscilloscopes

In contrast to the digital storage and digital phosphor oscilloscope architectures, the architecture of the digital sampling oscilloscope reverses the position of the attenuator/amplifier and the sampling bridge, as shown in Figure 17. The input signal is sampled before any attenuation or amplification is performed. A low bandwidth amplifier can then be utilized after the sampling bridge because the signal has already been converted to a lower frequency by the sampling gate, resulting in a much higher bandwidth instrument.

The tradeoff for this high bandwidth, however, is that the sampling oscilloscope's dynamic range is limited. Since there is no attenuator/amplifier in front of the sampling gate, there is no facility to scale the input. The sampling bridge must be able to handle the full dynamic range of the input at all times. Therefore, the dynamic range of most sampling oscilloscopes is limited to about 1 V peak-to-peak. Digital storage and digital phosphor oscilloscopes, on the other hand, can handle 50 to 100 volts.

In addition, protection diodes cannot be placed in front of the sampling bridge as this would limit the bandwidth. This reduces the safe input voltage for a sampling oscilloscope to about 3 V, as compared to 500 V available on other oscilloscopes.

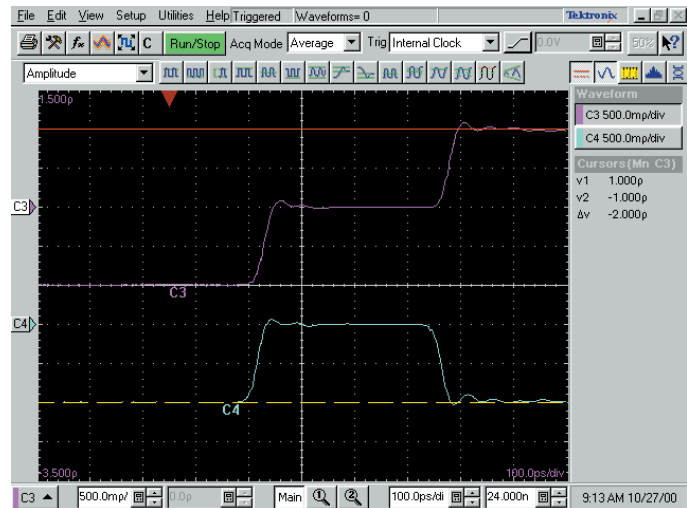

Figure 18. Time domain reflectometry (TDR) display from a digital sampling oscilloscope.

When measuring high-frequency signals, the DSO or DPO may not be able to collect enough samples in one sweep. A digital sampling oscilloscope is an ideal tool for accurately capturing signals whose frequency components are much higher than the oscilloscope's sample rate, as seen in Figure 18. This oscilloscope is capable of measuring signals of up to an order of magnitude faster than any other oscilloscope. It can achieve bandwidth and high-speed timing ten times higher than other oscilloscopes for repetitive signals. Sequential equivalent-time sampling oscilloscopes are available with bandwidths to 80 GHz.

## The Systems and Controls of an Oscilloscope

This section briefly describes the basic systems and controls found on analog and digital oscilloscopes. Some controls differ between analog and digital oscilloscopes; your oscilloscope probably has additional controls not discussed here.

A basic oscilloscope consists of four different systems – the vertical system, horizontal system, trigger system, and display system. Understanding each of these systems will enable you to effectively apply the oscilloscope to tackle your specific measurement challenges. Recall that each system contributes to the oscilloscope's ability to accurately reconstruct a signal.

The front panel of an oscilloscope is divided into three main sections labeled vertical, horizontal, and trigger. Your oscilloscope may have other sections, depending on the model and type. See if you can locate these front-panel sections in Figure 19, and on your oscilloscope, as you read through this section.

When using an oscilloscope, you need to adjust three basic settings to accommodate an incoming signal:

- **Vertical:** The attenuation or amplification of the signal. Use the volts/div control to adjust the amplitude of the signal to the desired measurement range.
- **Horizontal:** The time base. Use the sec/div control to set the amount of time per division represented horizontally across the screen.
- **Trigger:** The triggering of the oscilloscope. Use the trigger level to stabilize a repeating signal, or to trigger on a single event.



Figure 19. Front-panel control section of an oscilloscope.

### Common vertical controls include:

- Termination
  - 1M ohm
  - 50 ohm
- Coupling
  - DC
  - AC
  - GND
- Bandwidth
  - Limit
  - Enhancement
- Position
- Offset
- Invert – On/Off
- Scale
  - Fixed steps
  - Variable

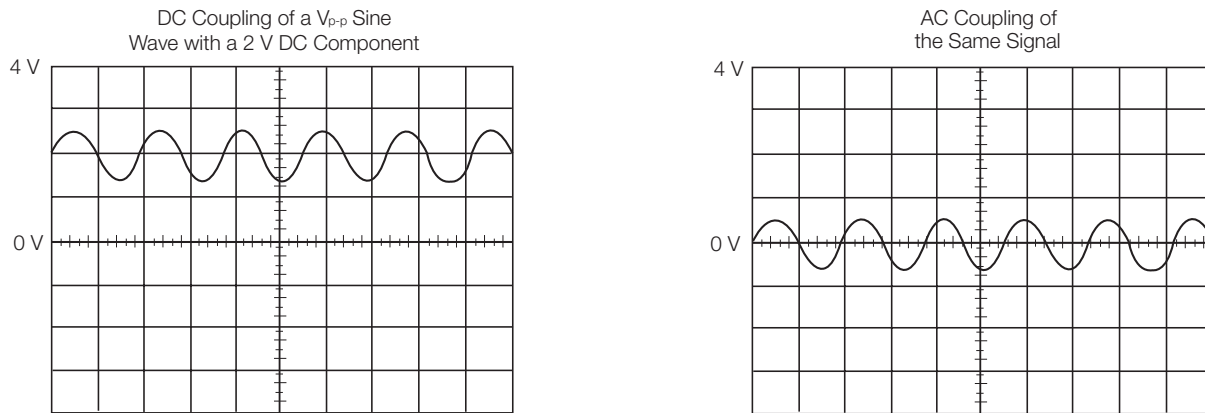

Figure 20. AC and DC input coupling.

## Vertical System and Controls

Vertical controls can be used to position and scale the waveform vertically, set the input coupling, and adjust other signal conditioning.

### Position and Volts per Division

The vertical position control allows you to move the waveform up and down exactly where you want it on the screen.

The volts-per-division setting (usually written as volts/div) is a scaling factor that varies the size of the waveform on the screen. If the volts/div setting is 5 volts, then each of the eight vertical divisions represents 5 volts and the entire screen can display 40 volts from bottom to top, assuming a graticule with eight major divisions. If the setting is 0.5 volts/div, the screen can display 4 volts from bottom to top, and so on. The maximum voltage you can display on the screen is the volts/div setting multiplied by the number of vertical divisions. Note that the probe you use, 1X or 10X, also influences the scale factor. You must divide the volts/div scale by the attenuation factor of the probe if the oscilloscope does not do it for you.

Often the volts/div scale has either a variable gain or a fine gain control for scaling a displayed signal to a certain number of divisions. Use this control to assist in taking rise time measurements.

### Input Coupling

Coupling refers to the method used to connect an electrical signal from one circuit to another. In this case, the input coupling is the connection from your test circuit to the oscilloscope. The coupling can be set to DC, AC, or ground. DC coupling shows all of an input signal. AC coupling blocks the DC component of a signal so that you see the waveform centered around zero volts. Figure 20 illustrates this difference. The AC coupling setting is useful when the entire signal (alternating current + direct current) is too large for the volts/div setting.

The ground setting disconnects the input signal from the vertical system, which lets you see where zero volts is located on the screen. With grounded input coupling and auto trigger mode, you see a horizontal line on the screen that represents zero volts. Switching from DC to ground and back again is a handy way of measuring signal voltage levels with respect to ground.

### Bandwidth Limit

Most oscilloscopes have a circuit that limits the bandwidth of the oscilloscope. By limiting the bandwidth, you reduce the noise that sometimes appears on the displayed waveform, resulting in a cleaner signal display. Note that, while eliminating noise, the bandwidth limit can also reduce or eliminate high-frequency signal content.

## Bandwidth Enhancement

Some oscilloscopes may provide a DSP arbitrary equalization filter which can be used to improve the oscilloscope channel response. This filter extends the bandwidth, flattens the oscilloscope channel frequency response, improves phase linearity, and provides a better match between channels. It also decreases rise time and improves the time domain step response.

## Horizontal System and Controls

An oscilloscope's horizontal system is most closely associated with its acquisition of an input signal – sample rate and record length are among the considerations here. Horizontal controls are used to position and scale the waveform horizontally.

## Acquisition Controls

Digital oscilloscopes have settings that let you control how the acquisition system processes a signal. Look over the acquisition options on your digital oscilloscope while you read this description. Figure 21 shows you an example of an acquisition menu.

## Acquisition Modes

Acquisition modes control how waveform points are produced from sample points. Sample points are the digital values derived directly from the analog-to-digital converter (ADC). The sample interval refers to the time between these sample points. Waveform points are the digital values that are stored in memory and displayed to construct the waveform. The time value difference between waveform points is referred to as the waveform interval.

### Common horizontal controls include:

- Time Base
- XY
- Scale
- Trace Separation
- Record Length
- Resolution
- Sample Rate
- Trigger Position
- Zoom/Pan
- Search

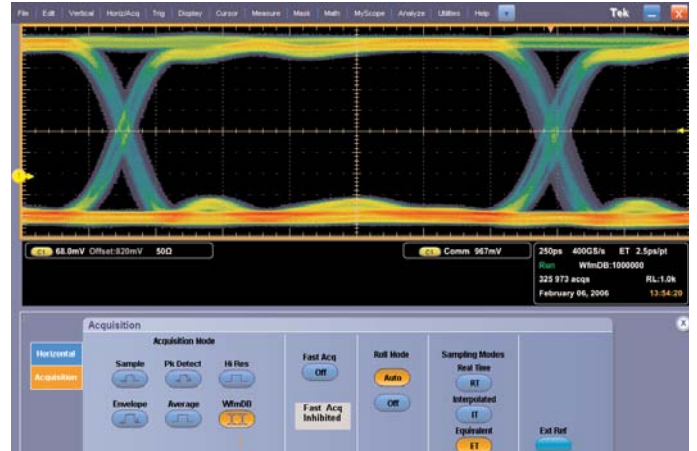
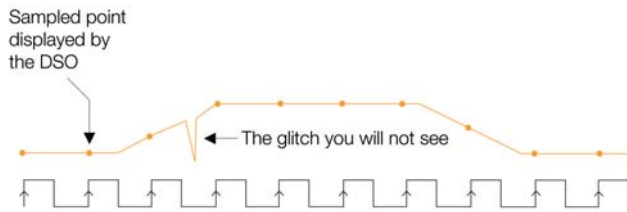

Figure 21. Example of an acquisition menu.

The sample interval and the waveform interval may, or may not, be the same. This fact leads to the existence of several different acquisition modes in which one waveform point is comprised of several sequentially acquired sample points. Additionally, waveform points can be created from a composite of sample points taken from multiple acquisitions, which provides another set of acquisition modes. A description of the most commonly used acquisition modes follows.



**Figure 22.** Sample rate varies with time base settings - the slower the time based setting, the slower the sample rate. Some digital oscilloscopes provide peak detect mode to capture fast transients at slow sweep speeds.

## Types of Acquisition Modes

- **Sample Mode:** This is the simplest acquisition mode. The oscilloscope creates a waveform point by saving one sample point during each waveform interval.
- **Peak Detect Mode:** The oscilloscope saves the minimum and maximum value sample points taken during two waveform intervals and uses these samples as the two corresponding waveform points. Digital oscilloscopes with peak detect mode run the ADC at a fast sample rate, even at very slow time base settings (slow time base settings translate into long waveform intervals) and are able to capture fast signal changes that would occur between the waveform points if in sample mode, as shown in Figure 22. Peak detect mode is particularly useful for seeing narrow pulses spaced far apart in time, as demonstrated in Figure 23.
- **Hi-Res Mode:** Like peak detect, hi res mode is a way of getting more information in cases when the ADC can sample faster than the time base setting requires. In this case, multiple samples taken within one waveform interval are averaged together to produce one waveform point. The result is a decrease in noise and an improvement in resolution for low-speed signals. The advantage of Hi Res Mode over Average is that Hi-Res Mode can be used even on a single shot event.
- **Envelope Mode:** Envelope mode is similar to peak detect mode. However, in envelope mode, the minimum and maximum waveform points from multiple acquisitions are combined to form a waveform that shows min/max accumulation over time. Peak detect mode is usually used to acquire the records that are combined to form the envelope waveform.

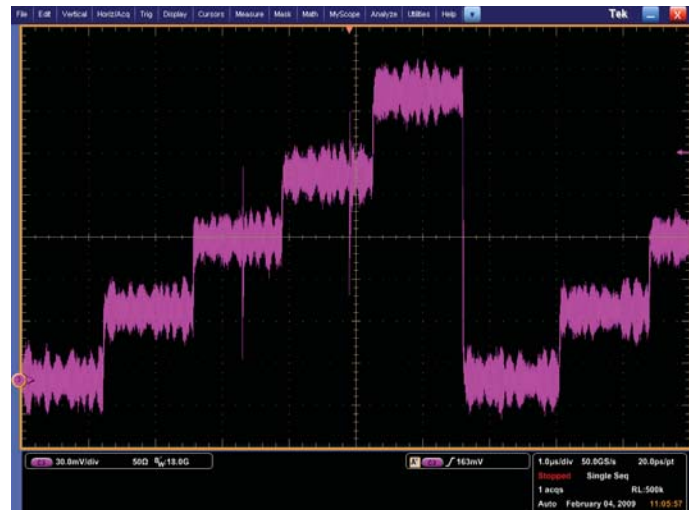
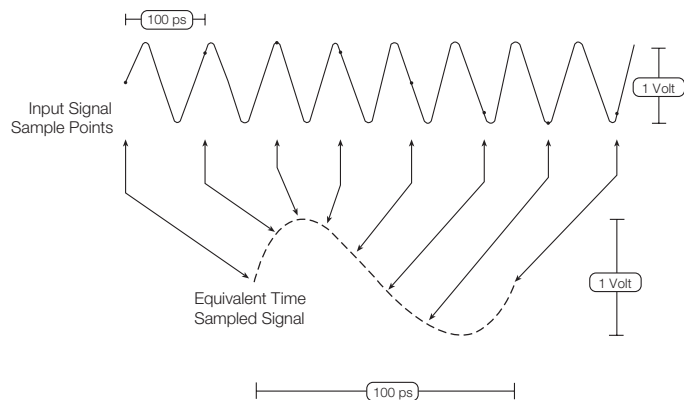

**Figure 23.** Peak detect mode enables the oscilloscope to capture extremely brief transient anomalies.

- **Average Mode:** In average mode, the oscilloscope saves one sample point during each waveform interval as in sample mode. However, waveform points from consecutive acquisitions are then averaged together to produce the final displayed waveform. Average mode reduces noise without loss of bandwidth, but requires a repeating signal.
- **Waveform Database Mode:** In waveform database mode, the oscilloscope accumulates a waveform database that provides a three-dimensional array of amplitude, time, and counts.

## Starting and Stopping the Acquisition System

One of the greatest advantages of digital oscilloscopes is their ability to store waveforms for later viewing. To this end, there are usually one or more buttons on the front panel that allow you to start and stop the acquisition system so you can analyze waveforms at your leisure. Additionally, you may want the oscilloscope to automatically stop acquiring after one acquisition is complete or after one set of records has been turned into an envelope or average waveform. This feature is commonly called single sweep or single sequence and its controls are usually found either with the other acquisition controls or with the trigger controls.



**Figure 24.** Basic sampling, showing sample points are connected by interpolation to produce a continuous waveform.

## Sampling

Sampling is the process of converting a portion of an input signal into a number of discrete electrical values for the purpose of storage, processing and/or display. The magnitude of each sampled point is equal to the amplitude of the input signal at the instant in time in which the signal is sampled.

Sampling is like taking snapshots. Each snapshot corresponds to a specific point in time on the waveform. These snapshots can then be arranged in the appropriate order in time so as to reconstruct the input signal.

In a digital oscilloscope, an array of sampled points is reconstructed on a display with the measured amplitude on the vertical axis and time on the horizontal axis, as illustrated in Figure 24.

The input waveform in Figure 24 appears as a series of dots on the screen. If the dots are widely spaced and difficult to interpret as a waveform, the dots can be connected using a process called interpolation. Interpolation connects the dots with lines, or vectors. A number of interpolation methods are available that can be used to produce an accurate representation of a continuous input signal.

## Sampling Controls

Some digital oscilloscopes provide you with a choice in sampling method – either real-time sampling or equivalent-time sampling. The acquisition controls available with these oscilloscopes will allow you to select a sample method to acquire signals. Note that this choice makes no difference for slow time base settings and only has an effect when the ADC cannot sample fast enough to fill the record with waveform points in one pass. Each sampling method has distinct advantages, depending on the kind of measurements being made.

Controls are typically available on modern oscilloscopes to give you the choice of three horizontal time base modes of operations. If you are simply doing signal exploration and want to interact with a lively signal, you will use the Automatic or interactive default mode that provides you with the liveliest display update rate. If you want a precise measurement and the highest real-time sample rate that will give you the most measurement accuracy, then the Constant Sample Rate mode is for you. It will maintain the highest sample rate and provide the best real-time resolution. The last mode is called the Manual mode because it ensures direct and independent control of the sample rate and record length.

## Real-time Sampling Method

Real-time sampling is ideal for signals whose frequency range is less than half the oscilloscope's maximum sample rate. Here, the oscilloscope can acquire more than enough points in one "sweep" of the waveform to construct an accurate picture, as shown in Figure 25. Real-time sampling is the only way to capture fast, single-shot, transient signals with a digital oscilloscope.

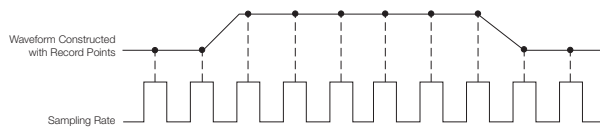

Figure 25. Real-time sampling method.

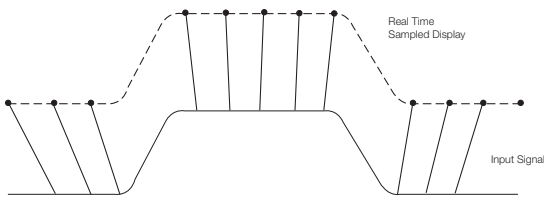

Figure 26. In order to capture this 10 ns pulse in real-time, the sample rate must be high enough to accurately define the edges.

Real-time sampling presents the greatest challenge for digital oscilloscopes because of the sample rate needed to accurately digitize high-frequency transient events, as shown in Figure 26. These events occur only once, and must be sampled in the same time frame that they occur.

If the sample rate isn't fast enough, high-frequency components can "fold down" into a lower frequency, causing aliasing in the display, as demonstrated in Figure 27. In addition, real-time sampling is further complicated by the high-speed memory required to store the waveform once it is digitized. Please refer to the Sample Rate and Record Length sections under Performance Terms and Considerations for additional detail regarding the sample rate and record length needed to accurately characterize high-frequency components.

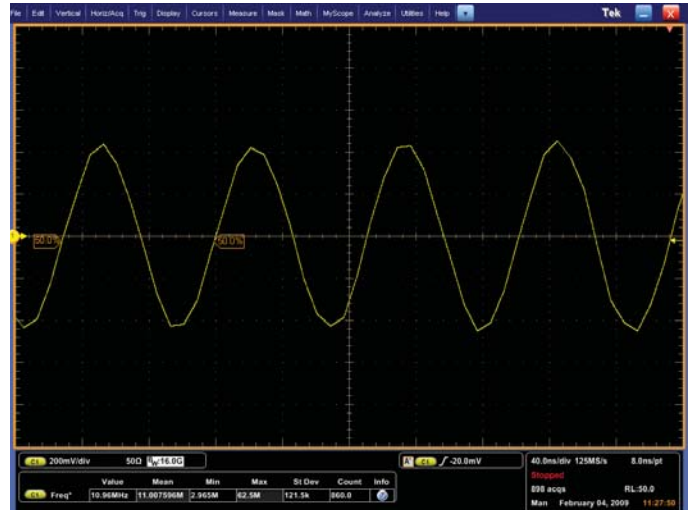
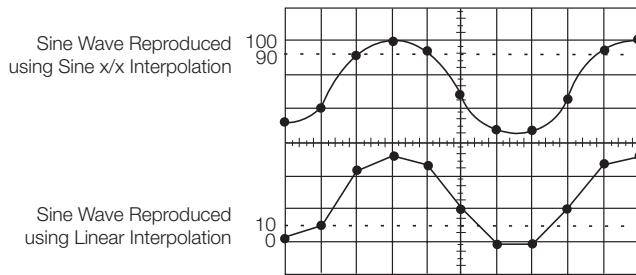

Figure 27. Undersampling of a 100 MHz sine wave introduces aliasing effects.

**Real-time sampling with interpolation**, digital oscilloscopes take discrete samples of the signal that can be displayed. However, it can be difficult to visualize the signal represented as dots, especially because there can be only a few dots representing high-frequency portions of the signal. To aid in the visualization of signals, digital oscilloscopes typically have interpolation display modes.

In simple terms, interpolation "connects the dots" so that a signal that is sampled only a few times in each cycle can be accurately displayed. Using real-time sampling with interpolation, the oscilloscope collects a few sample points of the signal in a single pass in real-time mode and uses interpolation to fill in the gaps. Interpolation is a processing technique used to estimate what the waveform looks like based on a few points.



**Figure 28.** Linear and sin  $x/x$  interpolation.

Linear interpolation connects sample points with straight lines. This approach is limited to reconstructing straight-edged signals, as illustrated in Figure 28, which better lends itself to square waves.

The more versatile sin  $x/x$  interpolation connects sample points with curves, as shown in Figure 28. Sin  $x/x$  interpolation is a mathematical process in which points are calculated to fill in the time between the real samples. This form of interpolation lends itself to curved and irregular signal shapes, which are far more common in the real world than pure square waves and pulses. Consequently, sin  $x/x$  interpolation is the preferred method for applications where the sample rate is 3 to 5 times the system bandwidth.

### Equivalent-time Sampling Method

When measuring high-frequency signals, the oscilloscope may not be able to collect enough samples in one sweep. Equivalent-time sampling can be used to accurately acquire signals whose frequency exceeds half the oscilloscope's sample rate, as illustrated in Figure 29. Equivalent-time

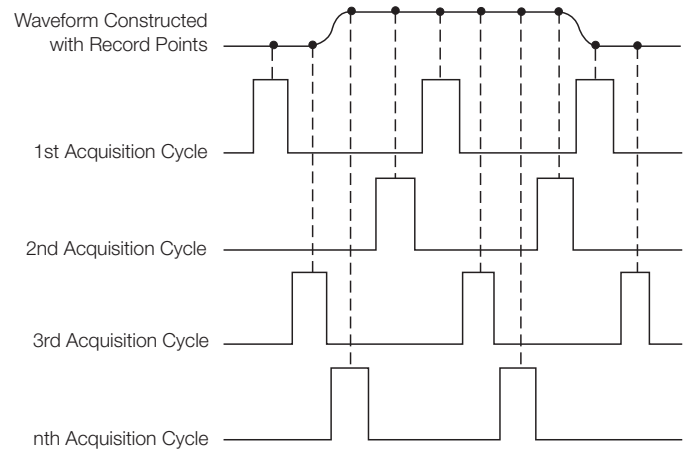
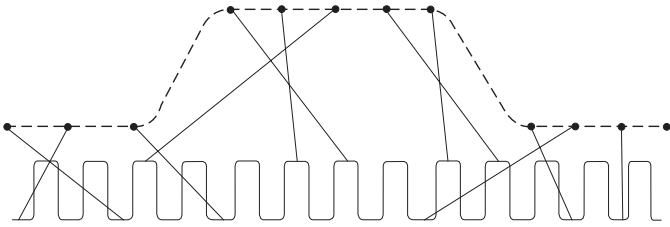

**Figure 29.** Some oscilloscopes use equivalent-time sampling to capture and display very fast, repetitive signals.

digitizers (samplers) take advantage of the fact that most naturally occurring and man-made events are repetitive. Equivalent-time sampling constructs a picture of a repetitive signal by capturing a little bit of information from each repetition. The waveform slowly builds up like a string of lights, illuminating one-by-one. This allows the oscilloscope to accurately capture signals whose frequency components are much higher than the oscilloscope's sample rate.

There are two types of equivalent-time sampling methods: random and sequential. Each has its advantages. Random equivalent-time sampling allows display of the input signal prior to the trigger point, without the use of a delay line. Sequential equivalent-time sampling provides much greater time resolution and accuracy. Both require that the input signal be repetitive.



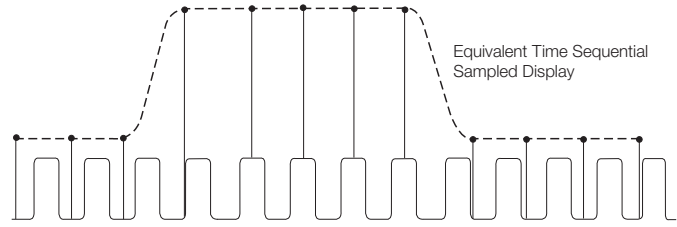

**Figure 30.** In random equivalent-time sampling, the sampling clock runs asynchronously with the input signal and the trigger.

### Random Equivalent-time Sampling

Random equivalent-time digitizers (samplers) utilize an internal clock that runs asynchronously with respect to the input signal and the signal trigger, as illustrated in Figure 30. Samples are taken continuously, independent of the trigger position, and are displayed based on the time difference between the sample and the trigger. Although samples are taken sequentially in time, they are random with respect to the trigger – hence the name “random” equivalent-time sampling. Sample points appear randomly along the waveform when displayed on the oscilloscope screen.

The ability to acquire and display samples prior to the trigger point is the key advantage of this sampling technique, eliminating the need for external pretrigger signals or delay lines. Depending on the sample rate and the time window of the display, random sampling may also allow more than one sample to be acquired per triggered event. However, at faster sweep speeds, the acquisition window narrows until the digitizer cannot sample on every trigger. It is at these faster sweep speeds that very precise timing measurements are often made, and where the extraordinary time resolution of the sequential equivalent-time sampler is most beneficial. The bandwidth limit for random equivalent-time sampling is less than for sequential-time sampling.



**Figure 31.** In sequential equivalent-time sampling, the single sample is taken for each recognized trigger after a time delay which is incremented after each cycle.

### Sequential Equivalent-time Sampling

The sequential equivalent-time sampler acquires one sample per trigger, independent of the time/div setting, or sweep speed, as illustrated in Figure 31. When a trigger is detected, a sample is taken after a very short, but well-defined, delay. When the next trigger occurs, a small time increment –  $\Delta t$  – is added to this delay and the digitizer takes another sample. This process is repeated many times, with “ $\Delta t$ ” added to each previous acquisition, until the time window is filled. Sample points appear from left to right in sequence along the waveform when displayed on the oscilloscope screen.

Technologically speaking, it is easier to generate a very short, very precise “ $\Delta t$ ” than it is to accurately measure the vertical and horizontal positions of a sample relative to the trigger point, as required by random samplers. This precisely measured delay is what gives sequential samplers their unmatched time resolution. Since, with sequential sampling, the sample is taken after the trigger level is detected, the trigger point cannot be displayed without an analog delay line, which may, in turn, reduce the bandwidth of the instrument. If an external pretrigger can be supplied, bandwidth will not be affected.

## Position and Seconds per Division

The horizontal position control moves the waveform left and right to exactly where you want it on the screen.

The seconds-per-division setting (usually written as sec/div) lets you select the rate at which the waveform is drawn across the screen (also known as the time base setting or sweep speed). This setting is a scale factor. If the setting is 1 ms, each horizontal division represents 1 ms and the total screen width represents 10 ms, or ten divisions. Changing the sec/div setting enables you to look at longer and shorter time intervals of the input signal.

As with the vertical volts/div scale, the horizontal sec/div scale may have variable timing, allowing you to set the horizontal time scale between the discrete settings.

## Time Base Selections

Your oscilloscope has a time base, which is usually referred to as the main time base. Many oscilloscopes also have what is called a delayed time base – a time base with a sweep that can start (or be triggered to start) relative to a pre-determined time on the main time base sweep. Using a delayed time base sweep allows you to see events more clearly and to see events that are not visible solely with the main time base sweep.

The delayed time base requires the setting of a time delay and the possible use of delayed trigger modes and other settings not described in this primer. Refer to the manual supplied with your oscilloscope for information on how to use these features.

## Zoom/Pan

Your oscilloscope may have special horizontal magnification settings that let you display a magnified section of the waveform on-screen. Some oscilloscopes add pan functions to the zoom capability. Knobs are used to adjust zoom factor or scale and the pan of the zoom box across the waveform.

## Search

Some oscilloscopes offer search and mark capabilities, enabling you to quickly navigate through long acquisitions looking for user-defined events.

## XY Mode

Most oscilloscopes have an XY mode that lets you display an input signal, rather than the time base, on the horizontal axis. This mode of operation opens up a whole new area of phase shift measurement techniques, explained in the Measurement Techniques section of this primer.

## Z Axis

A digital phosphor oscilloscope (DPO) has a high display sample density and an innate ability to capture intensity information. With its intensity axis (Z axis), the DPO is able to provide a three-dimensional, real-time display similar to that of an analog oscilloscope. As you look at the waveform trace on a DPO, you can see brightened areas – the areas where a signal occurs most often. This display makes it easy to distinguish the basic signal shape from a transient that occurs only once in a while – the basic signal would appear much brighter. One application of the Z axis is to feed special timed signals into the separate Z input to create highlighted “marker” dots at known intervals in the waveform.

## XYZ Mode with DPO and XYZ Record Display

Some DPOs can use the Z input to create an XY display with intensity grading. In this case, the DPO samples the instantaneous data value at the Z input and uses that value to qualify a specific part of the waveform. Once you have qualified samples, these samples can accumulate, resulting in an intensity-graded XYZ display. XYZ mode is especially useful for displaying the polar patterns commonly used in testing wireless communication devices – a constellation diagram, for example. Another method of displaying XYZ data is XYZ record display. In this mode the data from the acquisition memory is used rather than the DPO database.

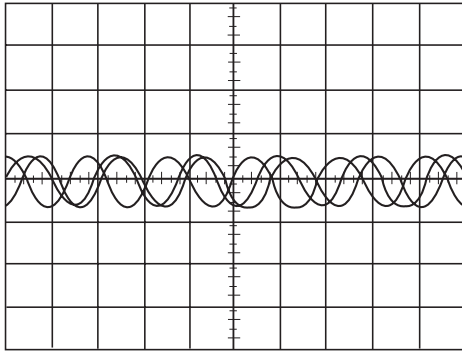

Figure 32. Untriggered display.

## Trigger System and Controls

An oscilloscope's trigger function synchronizes the horizontal sweep at the correct point of the signal, essential for clear signal characterization. Trigger controls allow you to stabilize repetitive waveforms and capture single-shot waveforms.

The trigger makes repetitive waveforms appear static on the oscilloscope display by repeatedly displaying the same portion of the input signal. Imagine the jumble on the screen that would result if each sweep started at a different place on the signal, as illustrated in Figure 32.

Edge triggering, available in analog and digital oscilloscopes, is the basic and most common type. In addition to threshold triggering offered by both analog and digital oscilloscopes, many digital oscilloscopes offer numerous specialized trigger settings not offered by analog instruments. These triggers respond to specific conditions in the incoming signal, making it easy to detect, for example, a pulse that is narrower than it should be. Such a condition would be impossible to detect with a voltage threshold trigger alone.

Advanced trigger controls enable you to isolate specific events of interest to optimize the oscilloscope's sample rate and record length. Advanced triggering capabilities in some oscilloscopes give you highly selective control. You can trigger on pulses defined by amplitude (such as runt pulses), qualified by time (pulse width, glitch, slew rate, setup-and-hold, and time-out), and delineated by logic state or pattern (logic triggering).

Other advanced trigger functions include:

- **Pattern Lock Triggering:** Pattern lock triggering adds a new dimension to NRZ serial pattern triggering by enabling the oscilloscope to take synchronized acquisitions of a long serial test pattern with outstanding time base accuracy. Pattern lock triggering can be used to remove random jitter from long serial data patterns. Effects of specific bit transitions can be investigated, and averaging can be used with mask testing.
- **Serial Pattern Triggering:** Serial pattern triggering can be used to debug serial architectures. It provides a trigger on the serial pattern of an NRZ serial data stream with built-in clock recovery and correlates events across the physical and link layer. The instrument can recover the clock signal, identify transitions, and allow you to set the desired encoded words for the serial pattern trigger to capture.
- **A & B Triggering:** Some trigger systems offer multiple trigger types only on a single event (A event), with delayed trigger (B event) selection limited to edge type triggering and often do not provide a way to reset the trigger sequence if the B event doesn't occur. Modern oscilloscopes can provide the full suite of advanced trigger types on both A and B triggers, logic qualification to control when to look for these events, and reset triggering to begin the trigger sequence again after a specified time, state, or transition so that even events in the most complex signals can be captured.
- **Search & Mark Triggering:** Hardware triggers watch for one event type at a time, but Search can scan for multiple event types simultaneously. For example, scan for setup or hold time violations on multiple channels. Individual marks can be placed by Search indicating events that meet search criteria.
- **Trigger Correction:** Since the trigger and data acquisition systems share different paths there is some inherent time delay between the trigger position and the data acquired. This results in skew and trigger jitter. With a trigger correction system the instrument adjusts the trigger position and compensates for the difference of delay there is between the trigger path and the data acquisition path. This will eliminate virtually any trigger jitter at the trigger point. In this mode, the trigger point can be used as a measurement reference.

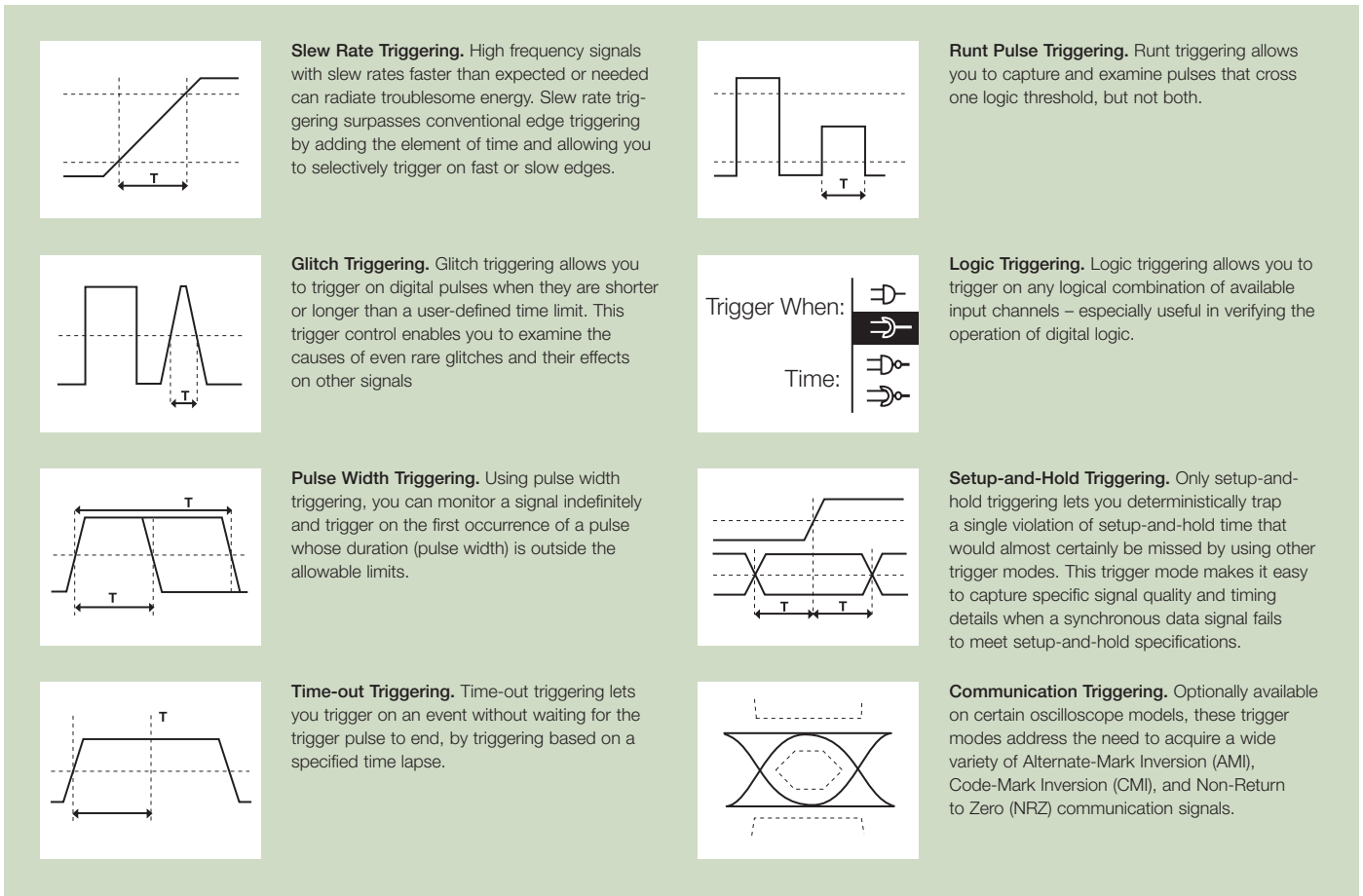

Figure 33. Common trigger types.

- **Serial Triggering on Specific Standard Signals I<sup>2</sup>C, CAN, LIN, etc.)** - Some oscilloscopes provide the ability to trigger on specific signal types for standard serial data signals such as CAN, LIN, I<sup>2</sup>C, SPI, and others. The decode of these signal types is also available on many oscilloscopes today.
- **Parallel Bus Triggering** - Multiple parallel buses can be defined and displayed at one time to easily view decoded parallel bus data over time. By specifying which channels are the clock and data lines, you can create a parallel bus display on some oscilloscopes that automatically decodes bus content. Countless hours can be saved by using parallel bus triggers to simplify capture and analysis.

Optional trigger controls in some oscilloscopes are designed specifically to examine communications signals as well. Figure 33 highlights a few of these common trigger types in more detail. The intuitive user interface available in some oscilloscopes also allows rapid setup of trigger parameters with wide flexibility in the test setup to maximize your productivity.

## Trigger Position

Horizontal trigger position control is only available on digital oscilloscopes. The trigger position control may be located in the horizontal control section of your oscilloscope. It actually represents the horizontal position of the trigger in the waveform record.

Varying the horizontal trigger position allows you to capture what a signal did before a trigger event, known as pre-trigger viewing. Thus, it determines the length of viewable signal both preceding and following a trigger point.

Digital oscilloscopes can provide pre-trigger viewing because they constantly process the input signal, whether or not a trigger has been received. A steady stream of data flows through the oscilloscope; the trigger merely tells the oscilloscope to save the present data in memory.

In contrast, analog oscilloscopes only display the signal – that is, write it on the CRT – after receiving the trigger. Thus, pre-trigger viewing is not available in analog oscilloscopes, with the exception of a small amount of pre-trigger provided by a delay line in the vertical system.

Pre-trigger viewing is a valuable troubleshooting aid. If a problem occurs intermittently, you can trigger on the problem, record the events that led up to it and, possibly, find the cause.

## Trigger Level and Slope

The trigger level and slope controls provide the basic trigger point definition and determine how a waveform is displayed, as illustrated in Figure 34.

The trigger circuit acts as a comparator. You select the slope and voltage level on one input of the comparator. When the trigger signal on the other comparator input matches your settings, the oscilloscope generates a trigger.

The slope control determines whether the trigger point is on the rising or the falling edge of a signal. A rising edge is a positive slope and a falling edge is a negative slope. The level control determines where on the edge the trigger point occurs.

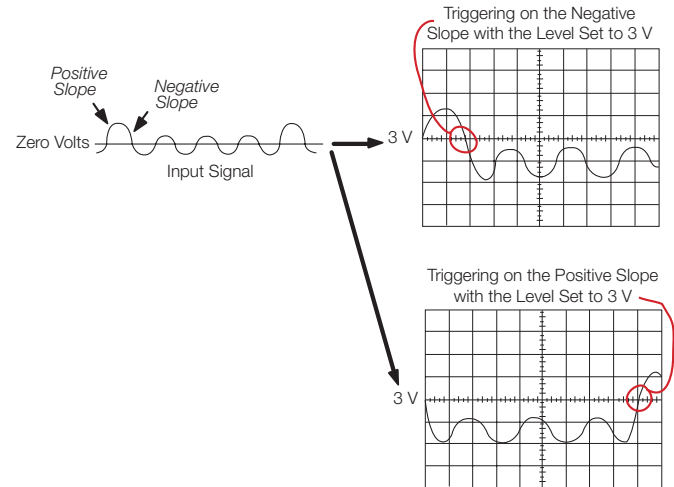

Figure 34. Positive and negative slope triggering.

## Trigger Sources

The oscilloscope does not necessarily need to trigger on the signal being displayed. Several sources can trigger the sweep:

- Any input channel
- An external source other than the signal applied to an input channel
- The power source signal
- A signal internally defined by the oscilloscope, from one or more input channels

Most of the time, you can leave the oscilloscope set to trigger on the channel displayed. Some oscilloscopes provide a trigger output that delivers the trigger signal to another instrument.

The oscilloscope can use an alternate trigger source, whether or not it is displayed, so you should be careful not to unwittingly trigger on channel 1 while displaying channel 2, for example.

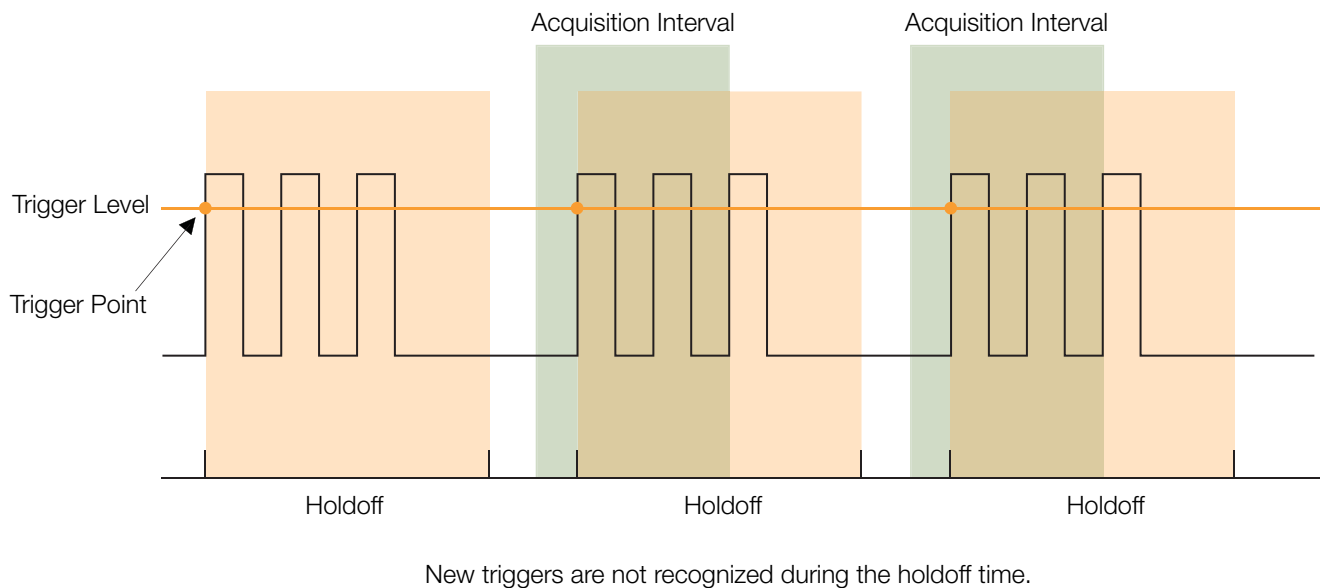

Figure 35. Trigger holdoff.

### Trigger Modes

The trigger mode determines whether or not the oscilloscope draws a waveform based on a signal condition. Common trigger modes include normal and auto.

In normal mode the oscilloscope only sweeps if the input signal reaches the set trigger point; otherwise (on an analog oscilloscope) the screen is blank or (on a digital oscilloscope) frozen on the last acquired waveform. Normal mode can be disorienting since you may not see the signal at first if the level control is not adjusted correctly.

Auto mode causes the oscilloscope to sweep, even without a trigger. If no signal is present, a timer in the oscilloscope triggers the sweep. This ensures that the display will not disappear if the signal does not cause a trigger.

In practice, you will probably use both modes: normal mode because it lets you see just the signal of interest, even when triggers occur at a slow rate, and auto mode because it requires less adjustment.

Many oscilloscopes also include special modes for single sweeps, triggering on video signals, or automatically setting the trigger level.

### Trigger Coupling

Just as you can select either AC or DC coupling for the vertical system, you can choose the kind of coupling for the trigger signal.

Besides AC and DC coupling, your oscilloscope may also have high frequency rejection, low frequency rejection, and noise rejection trigger coupling. These special settings are useful for eliminating noise from the trigger signal to prevent false triggering.

### Trigger Holdoff

Sometimes getting an oscilloscope to trigger on the correct part of a signal requires great skill. Many oscilloscopes have special features to make this task easier.

Trigger holdoff is an adjustable period of time after a valid trigger during which the oscilloscope cannot trigger. This feature is useful when you are triggering on complex waveform shapes, so that the oscilloscope only triggers on an eligible trigger point. Figure 35 shows how using trigger holdoff helps create a usable display.

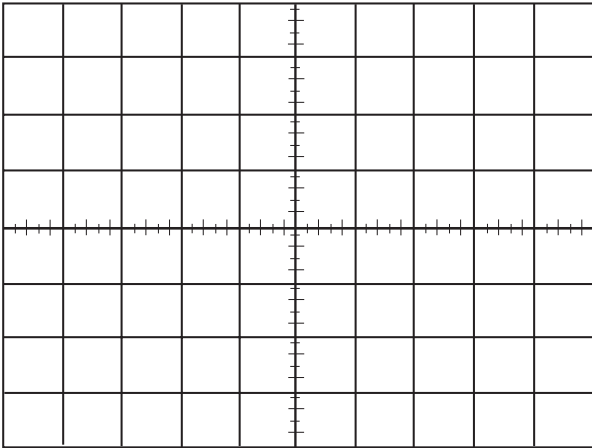

Figure 36. An oscilloscope graticule.

## Display System and Controls

An oscilloscope's front panel includes a display screen and the knobs, buttons, switches, and indicators used to control signal acquisition and display. As mentioned at the front of this section, front-panel controls are usually divided into vertical, horizontal and trigger sections. The front panel also includes input connectors.

Take a look at the oscilloscope display. Notice the grid markings on the screen – these markings create the graticule. Each vertical and horizontal line constitutes a major division. The graticule is usually laid out in an 8-by-10 or 10-by-10 division pattern. Labeling on the oscilloscope controls (such as volts/div and sec/div) always refers to major divisions. The tick marks on the center horizontal and vertical graticule lines, as shown in Figure 36, are called minor divisions. Many oscilloscopes display on the screen how many volts each vertical division represents and how many seconds each horizontal division represents.

## Other Oscilloscope Controls

### Math and Measurement Operations

Your oscilloscope may also have operations that allow you to add waveforms together, creating a new waveform display. Analog oscilloscopes combine the signals while digital oscilloscopes create new waveforms mathematically. Subtracting waveforms is another math operation. Subtraction with analog oscilloscopes is possible by using the channel invert function on one signal and then using

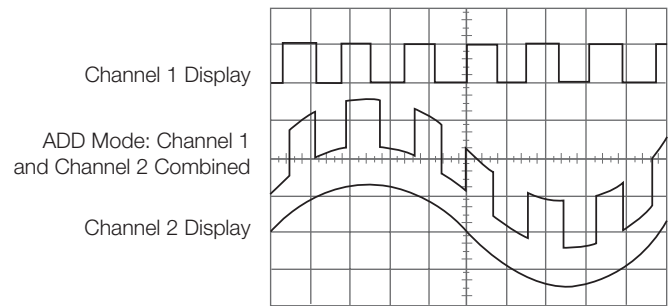

Figure 37. Adding channels.

the add operation. Digital oscilloscopes typically have a subtraction operation available. Figure 37 illustrates a third waveform created by combining two different signals.

Using the power of their internal processors, digital oscilloscopes offer many advanced math operations: multiplication, division, integration, Fast Fourier Transform, and more. This advanced signal processing capability can also perform functions such as the insertion of a filter block which can be used de-embed the characteristics of the fixture on the device under test or implement a filter block with desired frequency response such as a low pass filter. The processing block is flexible – not dedicated; it can perform as an arbitrary filter instead, for example for simulation of pre-emphasis/de-emphasis schemes.

### Digital Timing and State Acquisitions

Digital channels provided by a mixed signal oscilloscope enable acquisition capabilities similar to those found on logic analyzers. There are two major digital acquisition techniques. The first technique is timing acquisition in which the MSO samples the digital signal at uniformly spaced times determined by the MSO's sample rate. At each sample point, the MSO stores the signal's logic state and creates a timing diagram of the signal. The second digital acquisition technique is state acquisition. State acquisition defines special times that the digital signal's logic state is valid and stable. This is common in synchronous and clocked digital circuits. A clock signal defines the time when the signal state is valid. For example, the input signal stable time is around

the rising clock edge for a D-Flip-Flop with rising edge clocking. The output signal stable time is around the falling clock edge for a D-Flip-Flop with rising edge clocking. Since the clock period of a synchronous circuit may not be fixed, the time between state acquisitions may not be uniform as it is in a timing acquisition.

A mixed signal oscilloscope's digital channels acquire signals similar to how a logic analyzer acquires signals in timing acquisition mode. The MSO then decodes the timing acquisition into a clocked bus display, and event table which is similar to the logic analyzer's state acquisition display, providing you with important information during debug.

We have described the basic oscilloscope controls that a beginner needs to know about. Your oscilloscope may have other controls for various functions. Some of these may include:

- Automatic parametric measurements
- Measurement cursors
- Keypads for mathematical operations or data entry
- Printing capabilities
- Interfaces for connecting your oscilloscope to a computer or directly to the Internet

Look over the other options available to you and read your oscilloscope's manual to find out more about these other controls.

## The Complete Measurement System

### Probes

Even the most advanced instrument can only be as precise as the data that goes into it. A probe functions in conjunction with an oscilloscope as part of the measurement system. Precision measurements start at the probe tip. The right probes matched to the oscilloscope and the device-under-test (DUT) not only allow the signal to be brought to the oscilloscope cleanly, they also amplify and preserve the signal for the greatest signal integrity and measurement accuracy.

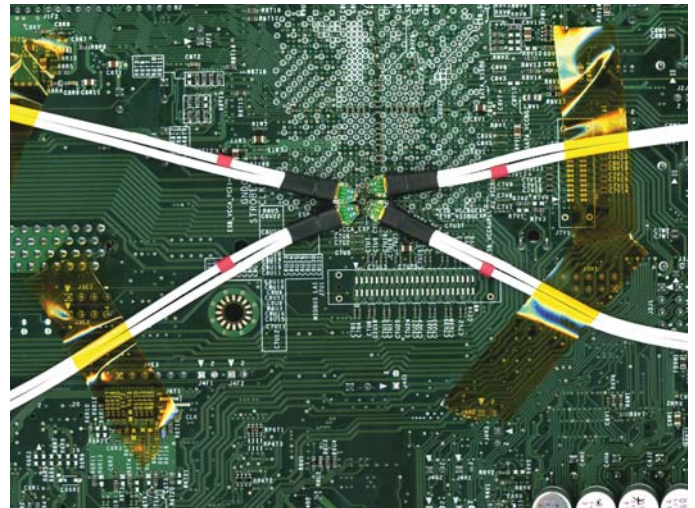

**Figure 38.** Dense devices and systems require small form factor probes.

To ensure accurate reconstruction of your signal, try to choose a probe that, when paired with your oscilloscope, exceeds the signal bandwidth by 5 times.

Probes actually become part of the circuit, introducing resistive, capacitive and inductive loading that inevitably alters the measurement. For the most accurate results, the goal is to select a probe with minimal loading. An ideal pairing of the probe with the oscilloscope will minimize this loading, and enable you to access all of the power, features and capabilities of your oscilloscope.

Another connectivity consideration is the probe's form factor. Small form factor probes provide easier access to today's densely packed circuitry, as shown in Figure 38.

A brief description of the types of probes follows. Please refer to the Tektronix ABCs of Probes primer for more information about this essential component of the overall measurement system.





Figure 39. A typical passive probe with accessories.

## Passive Probes

For measuring typical signal and voltage levels, passive probes provide ease-of-use and a wide range of measurement capabilities at an affordable price. The pairing of a passive voltage probe with a current probe will provide you with an ideal solution for measuring power.

Most passive probes have some attenuation factor, such as 10X, 100X, and so on. By convention, attenuation factors, such as for the 10X attenuator probe, have the X after the factor. In contrast, magnification factors like X10 have the X first.

The 10X (read as “ten times”) attenuator probe reduces circuit loading in comparison to a 1X probe and is an excellent general-purpose passive probe. Circuit loading becomes more pronounced for higher frequency and/or higher impedance signal sources, so be sure to analyze these signal/probe loading interactions before selecting a probe. The 10X attenuator probe improves the accuracy of your measurements, but also reduces the signal’s amplitude at the oscilloscope input by a factor of 10.

Because it attenuates the signal, the 10X attenuator probe makes it difficult to look at signals less than 10 millivolts peak-to-peak. The 1X probe is similar to the 10X attenuator probe but lacks the attenuation circuitry. Without this circuitry, more interference is introduced to the circuit being tested.

Use the 10X attenuator probe as your general-purpose probe, but keep the 1X probe accessible to measure slow-speed, low-amplitude signals. Some probes have a convenient feature for switching between 1X and 10X attenuation at the probe tip. If your probe has this feature, make sure you are using the correct setting before taking measurements.

Many oscilloscopes can automatically detect whether you are using a 1X or 10X probe and adjust their screen readouts accordingly. However with some oscilloscopes, you must set the type of probe you are using or read from the proper 1X or 10X marking on the volts/div control.

The 10X attenuator probe works by balancing the probe’s electrical properties against the oscilloscope’s electrical properties. Before using a 10X attenuator probe you need to adjust this balance for your particular oscilloscope. This adjustment is known as compensating the probe and is described in more detail in the Operating the Oscilloscope section of this primer.

Passive probes, such as the one shown in Figure 39, provide excellent general-purpose probing solutions. However, general-purpose passive probes cannot accurately measure signals with extremely fast rise times, and may excessively load sensitive circuits. The steady increase in signal clock rates and edge speeds demands higher speed probes with less loading effects. High-speed active and differential probes provide ideal solutions when measuring high-speed and/or differential signals.

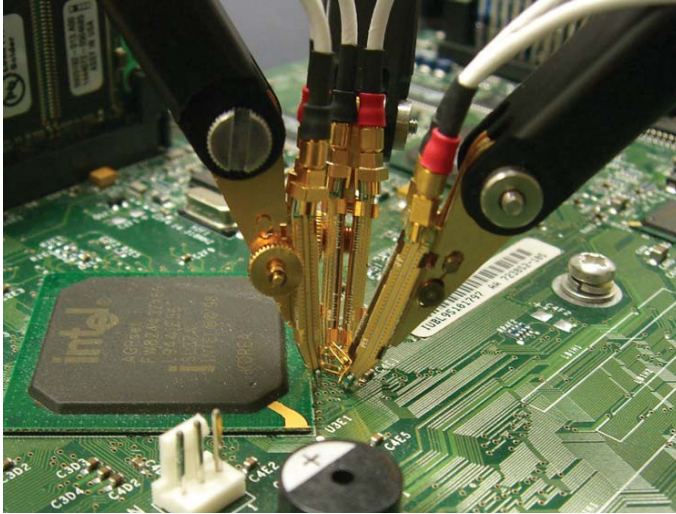

**Figure 40.** High-performance probes are critical when measuring the fast clocks and edges found in today's computer buses and data transmission lines.

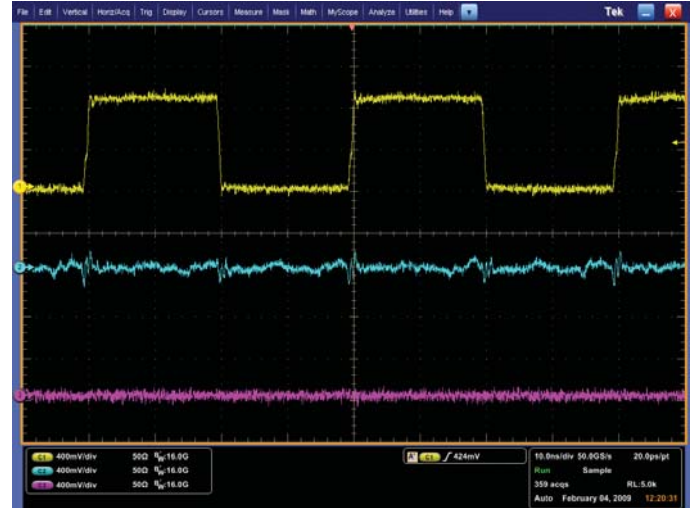

**Figure 41** Differential probes can separate common-mode noise from the signal content of interest in today's fast, low-voltage applications - especially important as digital signals continue to fall below typical noise thresholds found in integrated circuits.

## Active and Differential Probes

Increasing signal speeds and lower-voltage logic families make accurate measurement results difficult to achieve. Signal fidelity and device loading are critical issues. A complete measurement solution at these high speeds includes high-speed, high-fidelity probing solutions to match the performance of the oscilloscope, as shown in Figure 40.

Active and differential probes use specially developed integrated circuits to preserve the signal during access and transmission to the oscilloscope, ensuring signal integrity. For measuring signals with fast rise times, a high-speed active or differential probe will provide more accurate results, as highlighted in Figure 41.

Newer probe types provide the advantage of being able to use one setup, and get three types of measurements without adjusting probe tip connections. These probes can make differential, single-ended and common mode measurements from the same probe setup.

## Logic Probes

The logic probe shown in Figure 42 offers two eight-channel pods. Each channel ends with a probe tip featuring a recessed ground for simplified connection to the device-



**Figure 42.** Logic probes for a mixed signal oscilloscope (MSO) simplify digital connectivity to your device.

under-test. The coax on the first channel of each pod is colored blue making it easy to identify. The common ground uses an automotive style connector making it easy to create custom grounds for connecting to the device-under-test. When connecting to square pins, you can use an adapter that attaches to the probe head extending the probe ground flush with the probe tip so you can attach to a header. These probes offer outstanding electrical characteristics with minimal capacitive loading.

## Specialty Probes

In addition to the previously mentioned probe types, there are also a variety of other specialty probes and probing systems. These include current, high-voltage, and optical probes, just to name a few.

## Probe Accessories

Many modern oscilloscopes provide special automated features built into the input and mating probe connectors. In the case of intelligent probe interfaces, the act of connecting the probe to the instrument notifies the oscilloscope about the probe's attenuation factor, which in turn scales the display so that the probe's attenuation is figured into the readout on the screen. Some probe interfaces also recognize the type of probe – that is, passive, active or current. The interface may act as a DC power source for probes. Active probes have their own amplifier and buffer circuitry that requires DC power.

Ground lead and probe tip accessories are also available to improve signal integrity when measuring high-speed signals. Ground lead adapters provide spacing flexibility between probe tip and ground lead connections to the DUT, while maintaining very short lead lengths from probe tip to DUT.

Please refer to the Tektronix ABCs of Probes primer for more information about probes and probe accessories.

## Performance Terms and Considerations

As previously mentioned, an oscilloscope is analogous to a camera that captures signal images that we can observe and interpret. Shutter speed, lighting conditions, aperture and the ASA rating of the film all affect the camera's ability to capture an image clearly and accurately.

Like the basic systems of an oscilloscope, the performance considerations of an oscilloscope significantly affect its ability to achieve the required signal integrity.

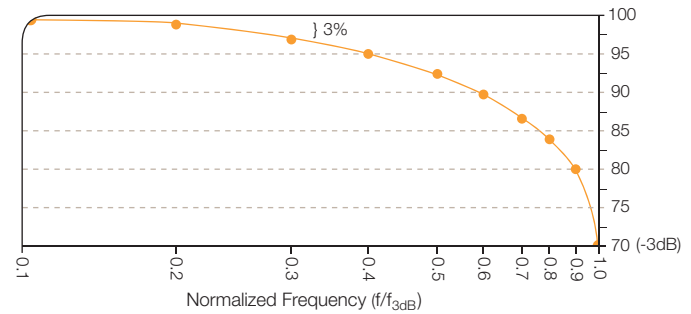

**Figure 43.** Oscilloscope bandwidth is the frequency at which a sinusoidal input signal is attenuated to 70.7% of the signal's true amplitude, known as the -3 dB point.

Learning a new skill often involves learning a new vocabulary. This idea holds true for learning how to use an oscilloscope. This section describes some useful measurement and oscilloscope performance terms. These terms are used to describe the criteria essential to choosing the right oscilloscope for your application. Understanding these terms will help you to evaluate and compare your oscilloscope with other models.

## Bandwidth

Bandwidth determines an oscilloscope's fundamental ability to measure a signal. As signal frequency increases, the capability of the oscilloscope to accurately display the signal decreases. This specification indicates the frequency range that the oscilloscope can accurately measure.

Oscilloscope bandwidth is specified as the frequency at which a sinusoidal input signal is attenuated to 70.7% of the signal's true amplitude, known as the -3 dB point, a term based on a logarithmic scale, as seen in Figure 43.

Without adequate bandwidth, your oscilloscope will not be able to resolve high-frequency changes. Amplitude will be distorted. Edges will vanish. Details will be lost. Without adequate bandwidth, all the features, bells and whistles in your oscilloscope will mean nothing.

To determine the oscilloscope bandwidth needed to accurately characterize signal amplitude in your specific application, apply the "5 Times Rule."

$$\text{Oscilloscope Bandwidth} \geq \frac{\text{Highest Frequency Component of Signal}}{5}$$

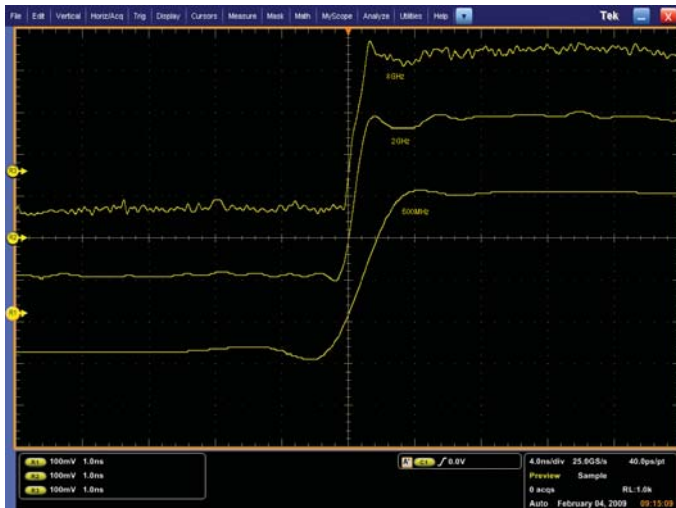

**Figure 44.** The higher the bandwidth, the more accurate the reproduction of your signal, as illustrated with a signal captured at 250 MHz, 1 GHz and 4 GHz bandwidth levels.

An oscilloscope selected using the 5 Times Rule will give you less than  $\pm 2\%$  error in your measurements – typically sufficient for today's applications. However, as signal speeds increase, it may not be possible to achieve this rule of thumb. Always keep in mind that higher bandwidth will likely provide more accurate reproduction of your signal, as demonstrated in Figure 44.

Some oscilloscopes provide a method of enhancing the bandwidth through digital signal processing. A DSP arbitrary equalization filter can be used to improve the oscilloscope channel response. This filter extends the bandwidth, flattens the oscilloscope's channel frequency response, improves phase linearity, and provides a better match between channels. It also decreases rise time and improves the time-domain step response.

## Rise Time

In the digital world, rise time measurements are critical. Rise time may be a more appropriate performance consideration when you expect to measure digital signals, such as pulses and steps. As shown in Figure 45, your oscilloscope must have sufficient rise time to accurately capture the details of rapid transitions.

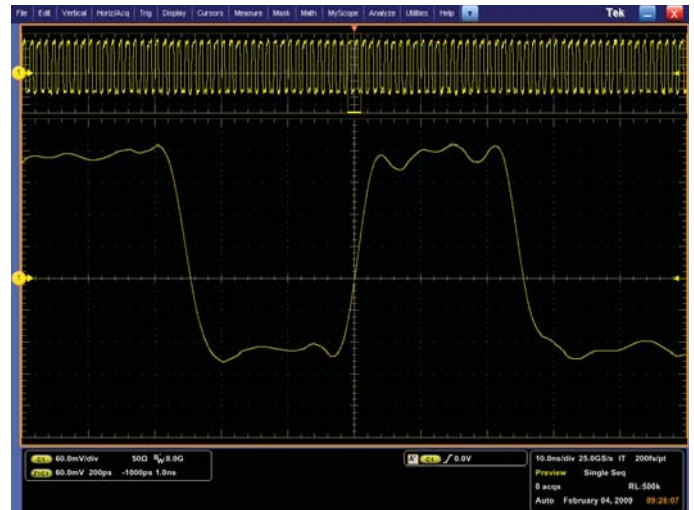

**Figure 45.** Rise time characterization of a high-speed digital signal.

Rise time describes the useful frequency range of an oscilloscope. To calculate the oscilloscope rise time required for your signal type, use the following equation:

$$\text{Oscilloscope Rise Time} \leq \text{Fastest Rise Time of Signal} \times \frac{1}{5}$$

Note that this basis for oscilloscope rise time selection is similar to that for bandwidth. As in the case of bandwidth, achieving this rule of thumb may not always be possible given the extreme speeds of today's signals. Always remember that an oscilloscope with faster rise time will more accurately capture the critical details of fast transitions.

In some applications, you may know only the rise time of a signal. A constant allows you to relate the bandwidth and rise time of the oscilloscope, using the equation:

$$\text{Bandwidth} = \frac{k}{\text{Rise Time}}$$

where  $k$  is a value between 0.35 and 0.45, depending on the shape of the oscilloscope's frequency response curve and pulse rise time response. Oscilloscopes with a bandwidth of  $< 1$  GHz typically have a 0.35 value, while oscilloscopes with a bandwidth of  $> 1$  GHz usually have a value between 0.40 and 0.45.

Logic Family	Typical Signal Rise Time	Calculated Signal Bandwidth
TTL	2 ns	175 MHz
CMOS	1.5 ns	230 MHz
GTL	1 ns	350 MHz
LVDS	400 ps	875 MHz
ECL	100 ps	3.5 GHz
GaAs	40 ps	8.75 GHz

Figure 46. Some logic families produce inherently faster rise times than others.

Some logic families produce inherently faster rise times than others, as illustrated in Figure 46.

## Sample Rate

Sample rate – specified in samples per second (S/s) – refers to how frequently a digital oscilloscope takes a snapshot or sample of the signal, analogous to the frames on a movie camera. The faster an oscilloscope samples (i.e., the higher the sample rate), the greater the resolution and detail of the displayed waveform and the less likely that critical information or events will be lost, as shown in Figure 47. The minimum sample rate may also be important if you need to look at slowly changing signals over longer periods of time. Typically, the displayed sample rate changes with changes made to the horizontal scale control to maintain a constant number of waveform points in the displayed waveform record.

How do you calculate your sample rate requirements? The method differs based on the type of waveform you are measuring, and the method of signal reconstruction used by the oscilloscope.

In order to accurately reconstruct a signal and avoid aliasing, the Nyquist theorem states that the signal must be sampled at least twice as fast as its highest frequency component. This theorem, however, assumes an infinite record length and a continuous signal. Since no oscilloscope offers infinite record length and, by definition, glitches are not continuous,

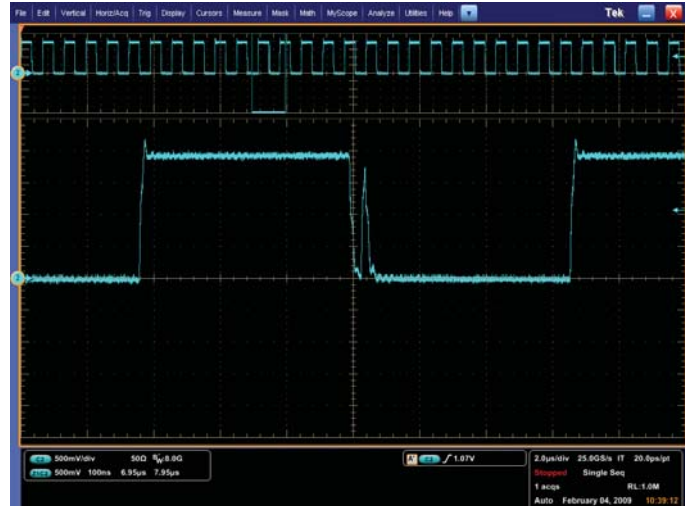

Figure 47. A higher sample rate provides greater signal resolution, ensuring that you'll see intermittent events.

sampling at only twice the rate of highest frequency component is usually insufficient.

In reality, accurate reconstruction of a signal depends on both the sample rate and the interpolation method used to fill in the spaces between the samples. Some oscilloscopes let you select either  $\sin(x)/x$  interpolation for measuring sinusoidal signals, or linear interpolation for square waves, pulses and other signal types.

For accurate reconstruction using  $\sin(x)/x$  interpolation, your oscilloscope should have a sample rate at least 2.5 times the highest frequency component of your signal. Using linear interpolation, the sample rate should be at least 10 times the highest frequency signal component.

Some measurement systems with sample rates to 50 GS/s and bandwidths to 20 GHz have been optimized for capturing very fast, single-shot and transient events by oversampling up to 5 times the bandwidth.



**Figure 48.** A DPO provides an ideal solution for non-repetitive, high-speed, multi-channel digital design applications.

## Waveform Capture Rate

All oscilloscopes blink. That is, they open their eyes a given number of times per second to capture the signal, and close their eyes in between. This is the waveform capture rate, expressed as waveforms per second (wfms/s). While the sample rate indicates how frequently the oscilloscope samples the input signal within one waveform, or cycle, the waveform capture rate refers to how quickly an oscilloscope acquires waveforms.

Waveform capture rates vary greatly, depending on the type and performance level of the oscilloscope. Oscilloscopes with high waveform capture rates provide significantly more visual insight into signal behavior, and dramatically increase the probability that the oscilloscope will quickly capture transient anomalies such as jitter, runt pulses, glitches and transition errors.

Digital storage oscilloscopes (DSOs) employ a serial-processing architecture to capture from 10 to 5,000 wfms/s. Some DSOs provide a special mode that bursts multiple captures into long memory, temporarily delivering higher waveform capture rates followed by long processing dead times that reduce the probability of capturing rare, intermittent events.

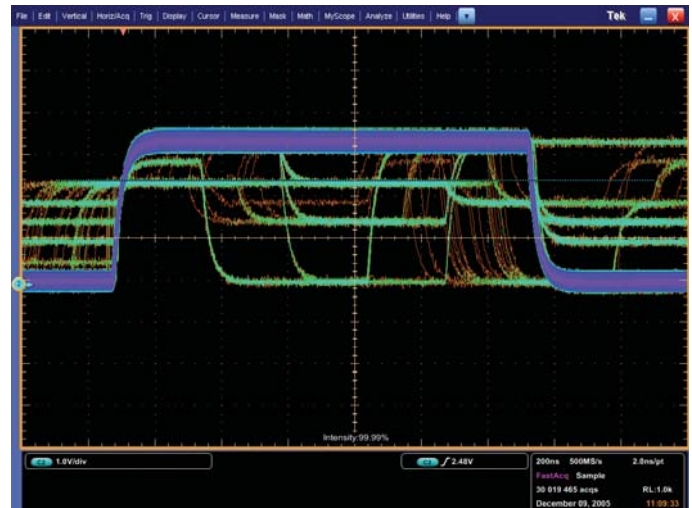

**Figure 49.** A DPO enables a superior level of insight into signal behavior by delivering vastly greater waveform capture rates and three-dimensional display, making it the best general-purpose design and troubleshooting tool for a wide range of applications.

Most digital phosphor oscilloscopes (DPOs) employ a parallel-processing architecture to deliver vastly greater waveform capture rates. As seen in Figure 48, some DPOs can acquire millions of waveforms in just seconds, significantly increasing the probability of capturing intermittent and elusive events and allowing you to see the problems in your signal more quickly. Moreover, the DPO's ability to acquire and display three dimensions of signal behavior in real time – amplitude, time and distribution of amplitude over time – results in a superior level of insight into signal behavior, as shown in Figure 49.

## Record Length

Record length, expressed as the number of points that comprise a complete waveform record, determines the amount of data that can be captured with each channel. Since an oscilloscope can store only a limited number of samples, the waveform duration (time) will be inversely proportional to the oscilloscope's sample rate.

$$\text{Time Interval} = \frac{\text{Record Length}}{\text{Sample Rate}}$$

Modern oscilloscopes allow you to select record length to optimize the level of detail needed for your application. If you are analyzing an extremely stable sinusoidal signal, you may need only a 500 point record length, but if you are isolating the causes of timing anomalies in a complex digital data stream, you may need a million points or more for a given record length, as demonstrated in Figure 50.

## Triggering Capabilities

An oscilloscope's trigger function synchronizes the horizontal sweep at the correct point of the signal, essential for clear signal characterization. Trigger controls allow you to stabilize repetitive waveforms and capture single-shot waveforms.

Please refer to the Trigger section under Performance Terms and Considerations for more information regarding triggering capabilities.

## Effective Bits

Effective bits represent a measure of a digital oscilloscope's ability to accurately reconstruct a sinewave signal's shape. This measurement compares the oscilloscope's actual error to that of a theoretical "ideal" digitizer. Because the actual errors include noise and distortion, the frequency and amplitude of the signal must be specified.

## Frequency Response

Bandwidth alone is not enough to ensure that an oscilloscope can accurately capture a high frequency signal. The goal of oscilloscope design is a specific type of frequency response: Maximally Flat Envelope Delay (MFED). A frequency response of this type delivers excellent pulse fidelity with minimum overshoot and ringing. Since a digital oscilloscope is composed of real amplifiers, attenuators, ADCs, interconnects, and relays, MFED response is a goal that can only be approached. Pulse fidelity varies considerably with model and manufacturer.

## Vertical Sensitivity

Vertical sensitivity indicates how much the vertical amplifier can amplify a weak signal – usually measured in millivolts (mV) per division. The smallest voltage detected by a general-purpose oscilloscope is typically about 1 mV per vertical screen division.

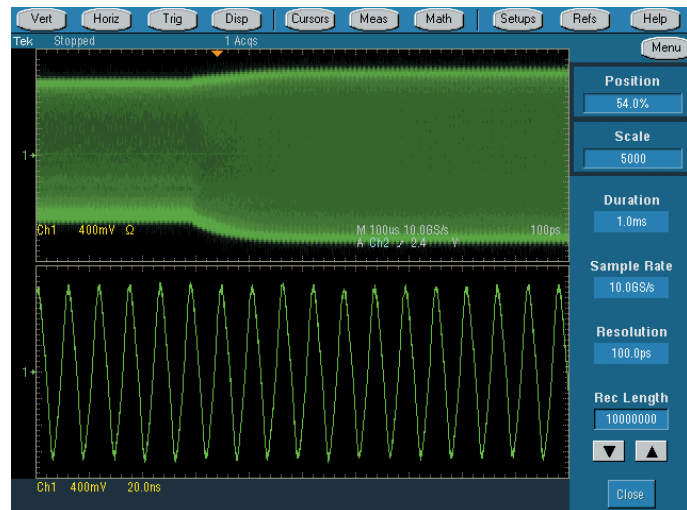

**Figure 50.** Capturing the high frequency detail of this modulated 85 MHz carrier requires high resolution sampling (100 ps). Seeing the signal's complete modulation envelope requires a long time duration (1 ms). Using long record length (10 MB), the oscilloscope can display both.

## Sweep Speed

Sweep speed indicates how fast the trace can sweep across the oscilloscope screen, enabling you to see fine details. The sweep speed of an oscilloscope is represented by time (seconds) per division.

## Gain Accuracy

Gain accuracy indicates how accurately the vertical system attenuates or amplifies a signal, usually represented as a percentage error.

## Horizontal Accuracy (Time Base)

Horizontal, or time base, accuracy indicates how accurately the horizontal system displays the timing of a signal, usually represented as a percentage error.

## Vertical Resolution (Analog-to-Digital Converter)

Vertical resolution of the ADC, and therefore, the digital oscilloscope, indicates how precisely it can convert input voltages into digital values. Vertical resolution is measured in bits. Calculation techniques can improve the effective resolution, as exemplified with hi-res acquisition mode.

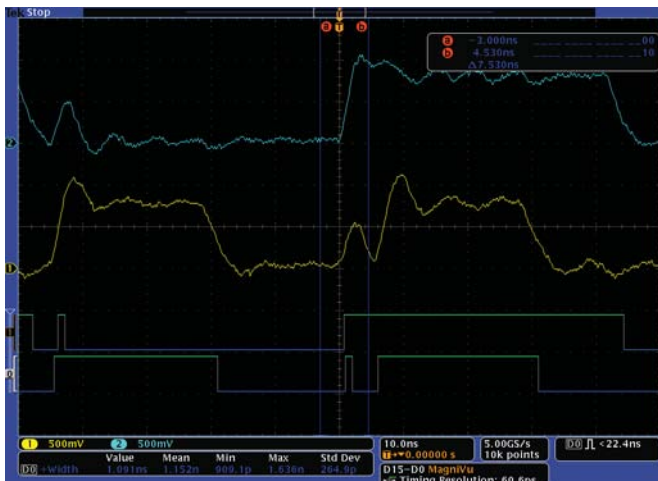

**Figure 51.** The MSO provides 16 integrated digital channels, enabling the ability to view and analyze time-correlated analog and digital signals. A high speed timing acquisition provides more resolution to reveal narrow events such as glitches.

### Timing Resolution (MSO)

An important MSO acquisition specification is the timing resolution used for capturing digital signals. Acquiring a signal with better timing resolution provides a more accurate timing measurement of when the signal changes. For example, a 500 MS/s acquisition rate has 2 ns timing resolution and the acquired signal edge uncertainty is 2 ns. A smaller timing resolution of 60.6 ps (16.5 GS/s) decreases the signal edge uncertainty to 60.6 ps and captures faster changing signals.

Some MSOs internally acquire digital signals with two types of acquisitions at the same time. The first acquisition is with standard timing resolution, and the second acquisition uses a high speed resolution. The standard resolution is used over a longer record length while the high speed timing acquisition offers more resolution around a narrow point of interest, as shown in Figure 51.

### Connectivity

The need to analyze measurement results remains of utmost importance. The need to document and share information and measurement results easily and frequently has also grown in importance. The connectivity of an oscilloscope delivers advanced analysis capabilities and simplifies the documentation and sharing of results. As shown in Figure 52, standard interfaces (GPIB, RS-232, USB, Ethernet) and network communication modules enable some oscilloscopes to deliver a vast array of functionality and control.



**Figure 52.** Today's oscilloscopes provide a wide array of communications interfaces, such as a standard Centronics port and optional Ethernet/RS-232, GPIB/RS-232, and VGA/RS-232 modules. There is even a USB port (not shown) on the front panel.

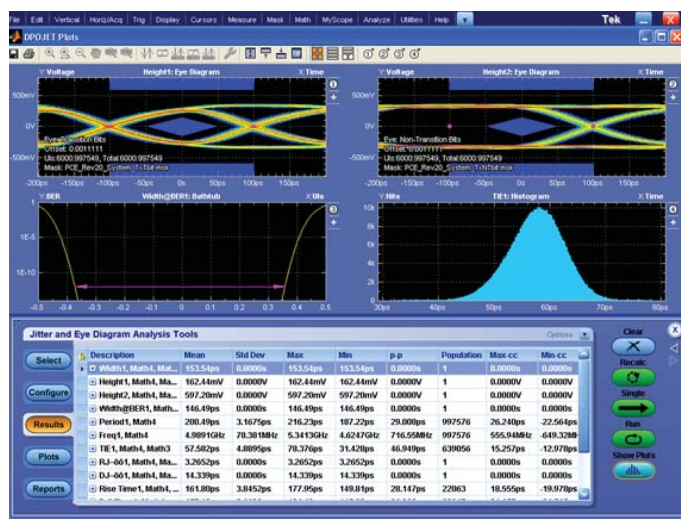

**Figure 53.** Analysis software packages are specifically designed to meet jitter and eye measurement needs of today's high-speed digital designers.

Some advanced oscilloscopes also let you:

- Create, edit and share documents on the oscilloscope – all while working with the instrument in your particular environment
- Access network printing and file sharing resources
- Access the Windows® desktop
- Run third-party analysis and documentation software
- Link to networks
- Access the Internet
- Send and receive e-mail

### Expandability

An oscilloscope should be able to accommodate your needs as they change. Some oscilloscopes allow you to:





Figure 54. Serial bus analysis is accelerated with automated trigger, decode, and search on serial packet context.

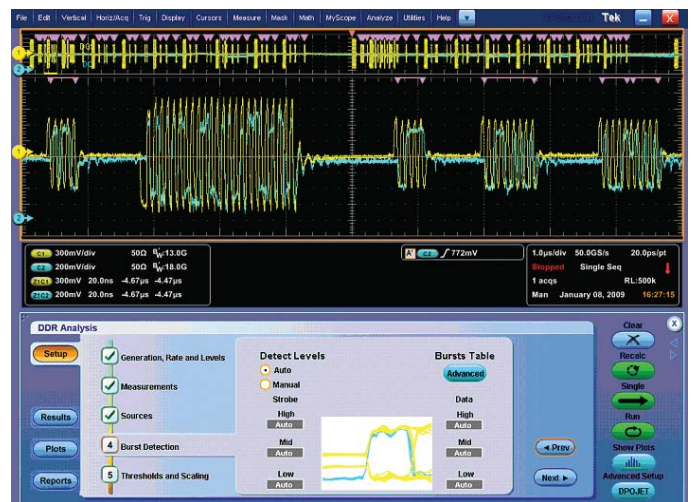

Figure 56. Advanced DDR analysis tools automate complex memory tasks like separating read/write bursts and performing JEDEC measurements.

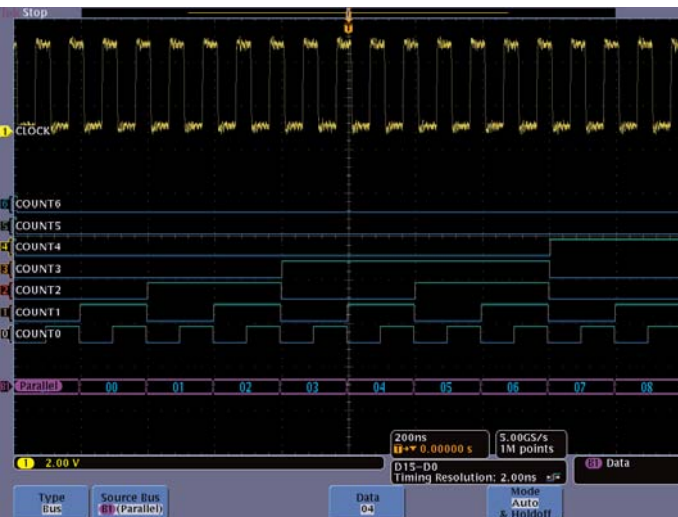

Figure 55. Automatically trigger, decode, and search on clocked or unclocked parallel bus data.

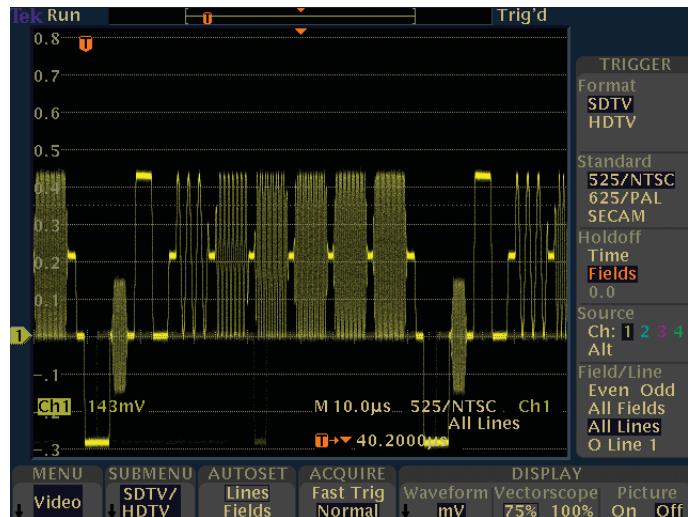

Figure 57. Video application modules make the oscilloscope a fast, tell-all tool for video troubleshooting.

- Add memory to channels to analyze longer record lengths
- Add application-specific measurement capabilities
- Complement the power of the oscilloscope with a full range of probes and modules
- Work with popular third-party analysis and productivity Windows-compatible software
- Add accessories, such as battery packs and rackmounts

Application modules and software may enable you to transform your oscilloscope into a highly specialized analysis tool capable of performing functions such as jitter and timing analysis, microprocessor memory system verification, communications standards testing, disk drive measurements, video measurements, power measurements and much more. Figures 53 - 58 highlight a few of these examples.

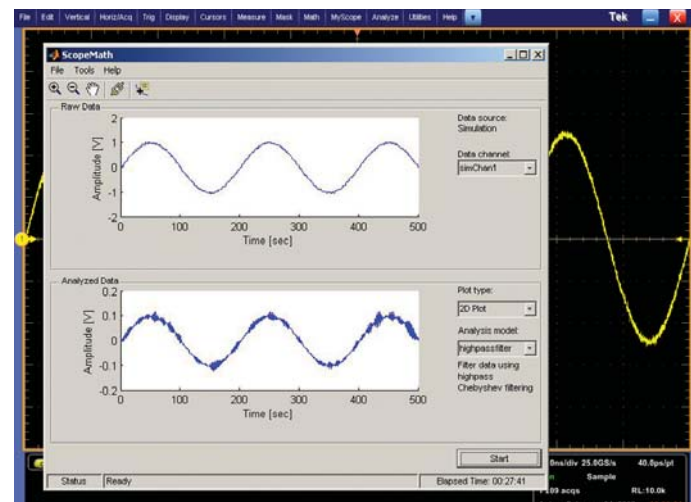

Figure 58. Advanced analysis and productivity software, such as MATLAB®, can be installed in Windows-based oscilloscopes to accomplish local signal analysis.



Figure 59. Traditional, analog-style knobs control position, scale, intensity, etc. – precisely as you would expect.

### Ease-of-Use

Oscilloscopes should be easy to learn and easy to use, helping you work at peak efficiency and productivity. Allowing you to focus on your design, rather than the measurement tools. Just as there is no one typical car driver, there is no one typical oscilloscope user. Regardless of whether you prefer a traditional instrument interface, or that of a Windows® interface, it is important to have flexibility in your oscilloscope's operation.

Many oscilloscopes offer a balance between performance and simplicity by providing the user with many ways to operate the instrument. A front-panel layout, in Figure 59, provides dedicated vertical, horizontal and trigger controls. An icon-rich graphical user interface, as shown in Figure 60, helps you understand and intuitively use advanced capabilities. Touch-sensitive displays solve issues with cluttered benches and carts, while providing access to clear, on-screen buttons, as seen in Figure 61. Online help provides a convenient, built-in reference manual. Intuitive controls allow

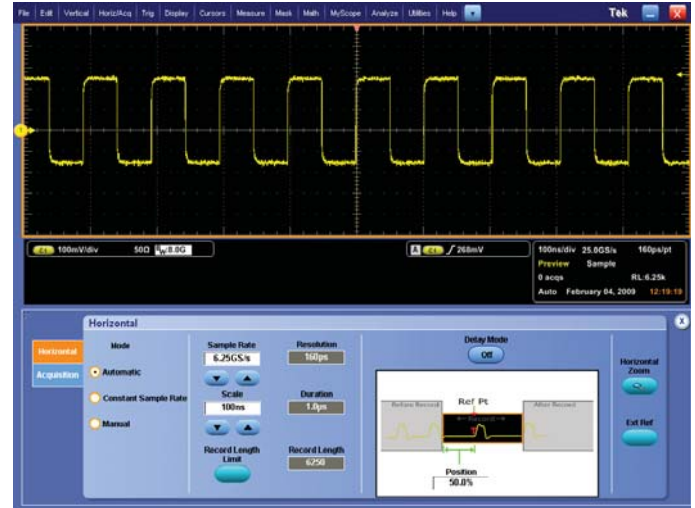

Figure 60. Use graphical control windows to access even the most sophisticated functions with confidence and ease.

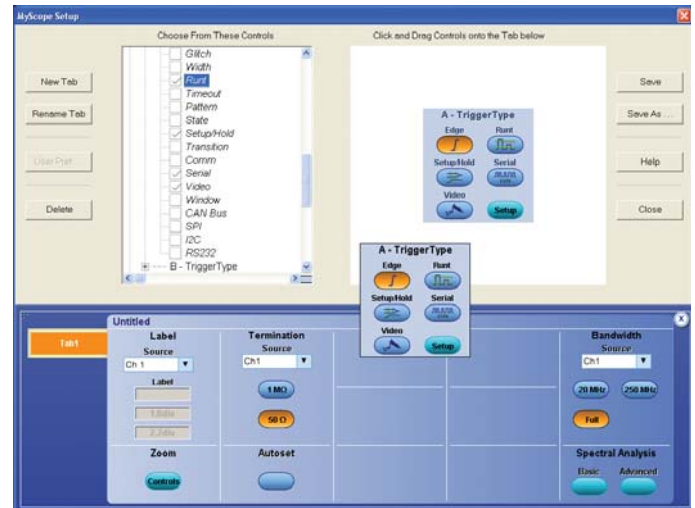

Figure 61. Touch-sensitive display naturally solves issues with cluttered benches and carts, while providing access to clear, on-screen buttons.

even occasional oscilloscope users to feel as comfortable driving the oscilloscope as they do driving a car, while giving full-time users easy access to the oscilloscope's most advanced features. In addition, many oscilloscopes are portable, such as the one shown in Figure 62, making the oscilloscope efficient in many different operating environments – in the lab or in the field.



**Figure 62.** The portability of many oscilloscopes makes the instrument efficient in many operating environments.

## Operating the Oscilloscope

This section briefly describes how to set up and start using an oscilloscope – specifically, how to properly ground the oscilloscope and yourself, set the oscilloscope controls, calibrate the oscilloscope, connect the probes, and compensate the probes.

Proper grounding is an important step when setting up to take measurements or work on a circuit. Proper grounding of the oscilloscope protects you from a hazardous shock and grounding yourself protects your circuits from damage.

### Proper Grounding

To ground the oscilloscope means to connect it to an electrically neutral reference point, such as earth ground. Ground your oscilloscope by plugging its three-pronged power cord into an outlet grounded to earth ground.

Grounding the oscilloscope is necessary for safety. If a high voltage contacts the case of an ungrounded oscilloscope – any part of the case, including knobs that appear insulated – it can give you a shock. However, with a properly grounded oscilloscope, the current travels through the grounding path to earth ground rather than through you to earth ground.

Grounding is also necessary for taking accurate measure-

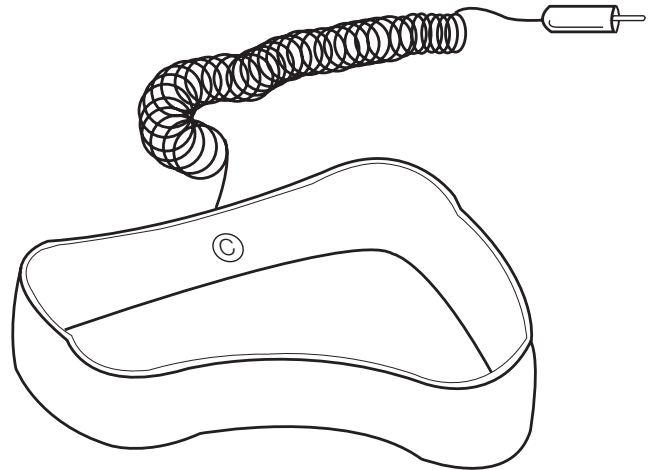

**Figure 63.** Typical wrist-type grounding strap.

ments with your oscilloscope. The oscilloscope needs to share the same ground as any circuits you are testing.

Some oscilloscopes do not require separate connection to earth ground. These oscilloscopes have insulated cases and controls, which keeps any possible shock hazard away from the user.

If you are working with integrated circuits (ICs), you also need to ground yourself. Integrated circuits have tiny conduction paths that can be damaged by static electricity that builds up on your body. You can ruin an expensive IC simply by walking across a carpet or taking off a sweater and then touching the leads of the IC. To solve this problem, wear a grounding strap, as shown in Figure 63. This strap safely sends static charges on your body to earth ground.

### Setting the Controls

After plugging in the oscilloscope, take a look at the front panel. As described previously, the front panel is typically divided into three main sections labeled vertical, horizontal, and trigger. Your oscilloscope may have other sections, depending on the model and type.

Notice the input connectors on your oscilloscope – this is where you attach the probes. Most oscilloscopes have at least two input channels and each channel can display a

waveform on the screen. Multiple channels are useful for comparing waveforms. As mentioned earlier, MSOs also have digital inputs as well.

Some oscilloscopes have AUTOSET and/or DEFAULT buttons that can set up the controls in one step to accommodate a signal. If your oscilloscope does not have this capability, it is helpful to set the controls to standard positions before taking measurements.

General instructions to manually set up the oscilloscope in standard positions are as follows:

- Set the oscilloscope to display channel 1
- Set the vertical volts/division scale and position controls to mid-range positions
- Turn off the variable volts/division
- Turn off all magnification settings
- Set the channel 1 input coupling to DC
- Set the trigger mode to auto
- Set the trigger source to channel 1
- Turn trigger holdoff to minimum or off
- Set the horizontal time/division and position controls to mid-range positions
- Adjust channel 1 volts/division such that the signal occupies as much of the 10 vertical divisions as possible without clipping or signal distortion

## Calibrating the Instrument

In addition to proper oscilloscope setup, periodic instrument self-calibration is recommended for accurate measurements. Calibration is needed if the ambient temperature has changed more than 5°C (9°F) since the last self-calibration or once a week. In the oscilloscope menu this can sometimes be initiated as “Signal Path Compensation”. Refer to the manual that accompanied your oscilloscope for more detailed instructions.

## Connecting the Probes

Now you are ready to connect a probe to your oscilloscope. A probe, if well-matched to the oscilloscope, will enable you to access all of the power and performance in the oscilloscope and will ensure the integrity of the signal you are measuring.

Measuring a signal requires two connections: the probe tip connection and the ground connection. Probes often come with a clip attachment for grounding the probe to the circuit under test. In practice, you attach the grounding clip to a known ground in the circuit, such as the metal chassis of a product you are repairing, and touch the probe tip to a test point in the circuit

## Compensating the Probes

Passive attenuation voltage probes must be compensated to the oscilloscope. Before using a passive probe, you need to compensate it – to balance its electrical properties to a particular oscilloscope.

You should get into the habit of compensating the probe every time you set up your oscilloscope. A poorly adjusted probe can make your measurements less accurate. Figure 64 illustrates the effects on a 1 MHz test signal when using a probe that is not properly compensated.

Most oscilloscopes have a square wave reference signal available at a terminal on the front panel used to compensate the probe. General instructions to compensate the probe are as follows:

- Attach the probe to a vertical channel
- Connect the probe tip to the probe compensation, i.e. square wave reference signal
- Attach the ground clip of the probe to ground
- View the square wave reference signal
- Make the proper adjustments on the probe so that the corners of the square wave are square

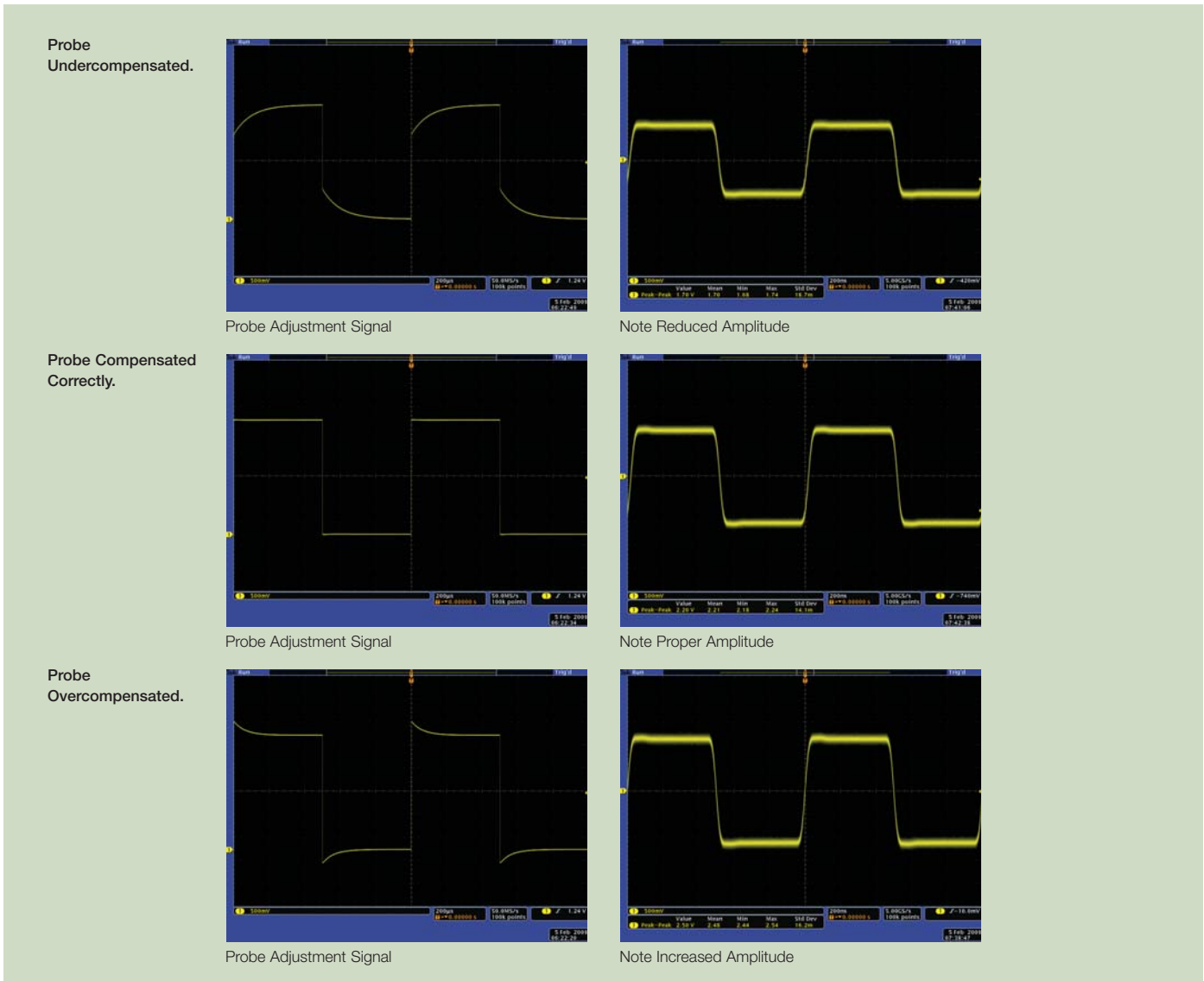

Figure 64. The effects of improper probe compensation.

When you compensate the probe, always attach any accessory tips you will use and connect the probe to the vertical

channel you plan to use. This will ensure that the oscilloscope has the same electrical properties as it does when you take measurements.

## Oscilloscope Measurement Techniques

This section reviews basic measurement techniques. The two most basic measurements you can make are voltage and time measurements. Just about every other measurement is based on one of these two fundamental techniques.

This section discusses methods for taking measurements visually with the oscilloscope screen. This is a common technique with analog instruments, and also may be useful for “at-a-glance” interpretation of digital oscilloscope displays.

Note that most digital oscilloscopes include automated measurement tools that simplify and accelerate common analysis tasks, thus improving the reliability and confidence of your measurements. However, knowing how to make measurements manually as described here will help you understand and check the automatic measurements.

### Voltage Measurements

Voltage is the amount of electric potential, expressed in volts, between two points in a circuit. Usually one of these points is ground (zero volts), but not always. Voltages can also be measured from peak-to-peak – from the maximum point of a signal to its minimum point. You must be careful to specify which voltage you mean.

The oscilloscope is primarily a voltage-measuring device. Once you have measured the voltage, other quantities are just a calculation away. For example, Ohm’s law states that voltage between two points in a circuit equals the current times the resistance. From any two of these quantities you can calculate the third using the following formula:

$$\begin{aligned} \text{Voltage} &= \text{Current} \times \text{Resistance} \\ \text{Current} &= \frac{\text{Voltage}}{\text{Resistance}} \\ \text{Resistance} &= \frac{\text{Voltage}}{\text{Current}} \end{aligned}$$

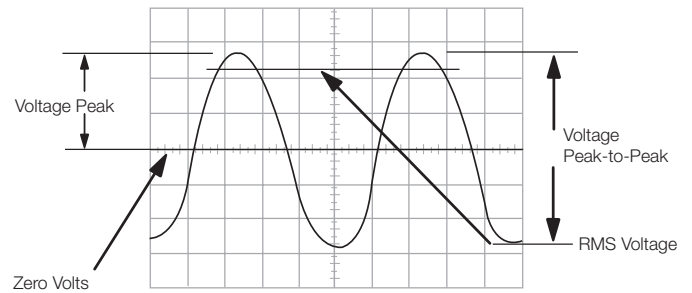

Figure 65. Voltage peak ( $V_p$ ) and peak-to-peak voltage ( $V_{p-p}$ )

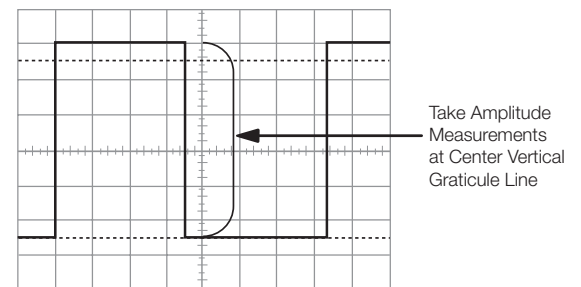

Figure 66. Measure voltage on the center vertical graticule line.

Another handy formula is the power law, which states that the power of a DC signal equals the voltage times the current. Calculations are more complicated for AC signals, but the point here is that measuring the voltage is the first step toward calculating other quantities. Figure 65 shows the voltage of one peak ( $V_p$ ) and the peak-to-peak voltage ( $V_{p-p}$ ).

The most basic method of taking voltage measurements is to count the number of divisions a waveform spans on the oscilloscope’s vertical scale. Adjusting the signal to cover most of the display vertically makes for the best voltage measurements, as shown in Figure 66. The more display area you use, the more accurately you can read the measurement.

Many oscilloscopes have cursors that let you make waveform measurements automatically, without having to count graticule marks. A cursor is simply a line that you can move across the display. Two horizontal cursor lines can be moved up and down to bracket a waveform’s amplitude for voltage measurements, and two vertical lines move right and left for time measurements. A readout shows the voltage or time at their positions.

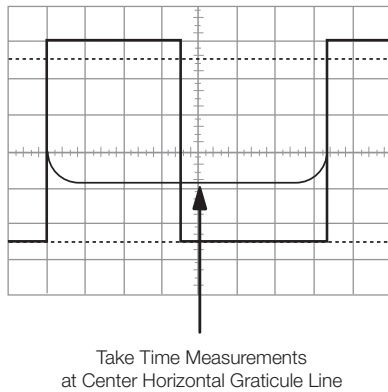

Figure 67. Measure time on the center horizontal graticule line.

## Time and Frequency Measurements

You can make time measurements using the horizontal scale of the oscilloscope. Time measurements include measuring the period and pulse width of pulses. Frequency is the reciprocal of the period, so once you know the period, the frequency is one divided by the period. Like voltage measurements, time measurements are more accurate when you adjust the portion of the signal to be measured to cover a large area of the display, as illustrated in Figure 67.

## Pulse Width and Rise Time Measurements

In many applications, the details of a pulse's shape are important. Pulses can become distorted and cause a digital circuit to malfunction, and the timing of pulses in a pulse train is often significant.

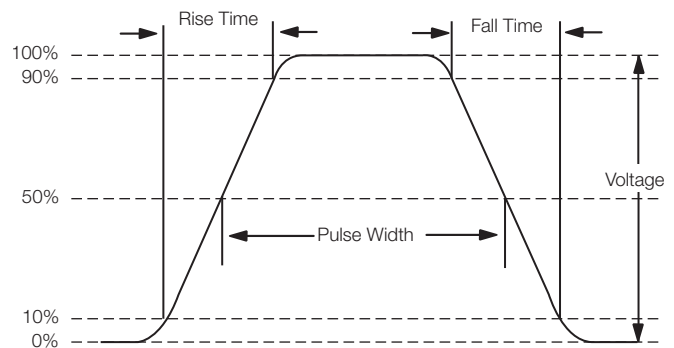

Figure 68. Rise time and pulse width measurement points.

Standard pulse measurements are pulse rise time and pulse width. Rise time is the amount of time a pulse takes to go from a low to high voltage. By convention, the rise time is measured from 10% to 90% of the full voltage of the pulse. This eliminates any irregularities at the pulse's transition corners. Pulse width is the amount of time the pulse takes to go from low to high and back to low again. By convention, the pulse width is measured at 50% of full voltage. Figure 68 illustrates these measurement points.

Pulse measurements often require fine-tuning the triggering. To become an expert at capturing pulses, you should learn how to use trigger holdoff and how to set the digital oscilloscope to capture pretrigger data, as described in the Systems and Controls of an Oscilloscope section. Horizontal magnification is another useful feature for measuring pulses, since it allows you to see fine details of a fast pulse.

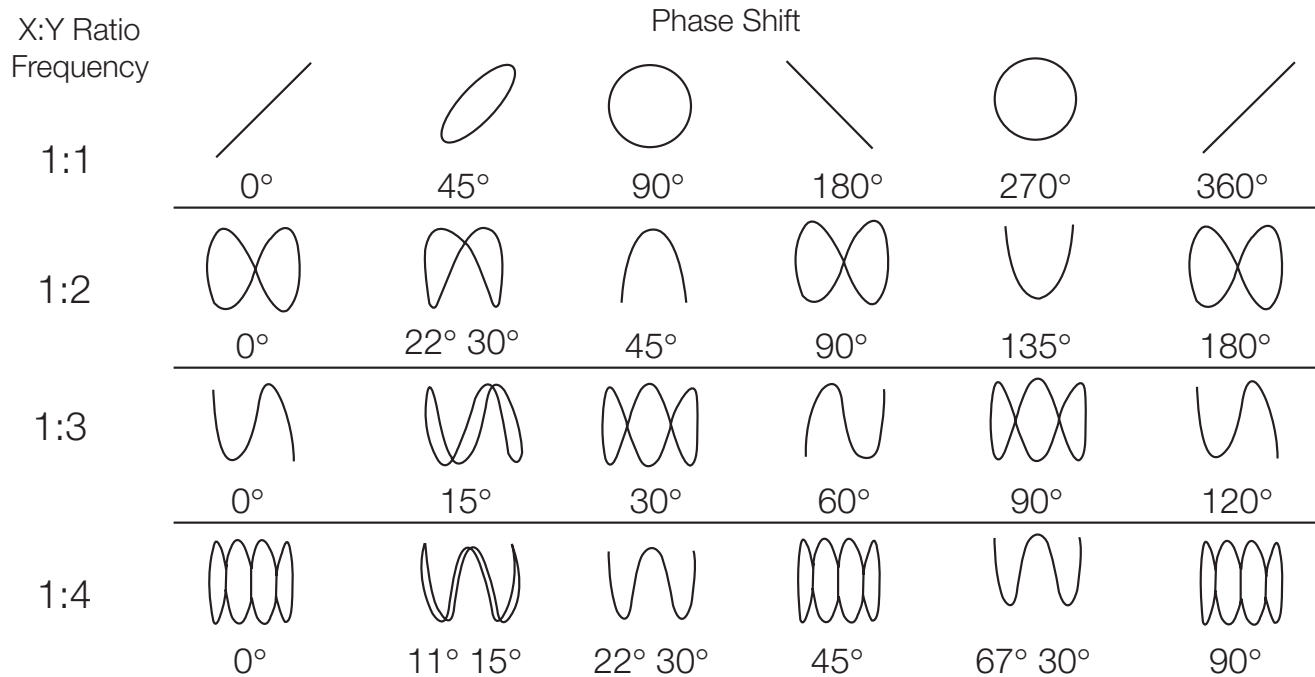

Figure 69. Lissajous patterns.

## Phase Shift Measurements

One method for measuring phase shift – the difference in timing between two otherwise identical periodic signals – is to use XY mode. This measurement technique involves inputting one signal into the vertical system as usual and then another signal into the horizontal system – called an XY measurement because both the X and Y axis are tracing voltages. The waveform that results from this arrangement is called a Lissajous pattern (named for French physicist Jules Antoine Lissajous and pronounced LEE–sa–zhoo). From the shape of the Lissajous pattern, you can tell the phase difference between the two signals. You can also tell their frequency ratio. Figure 69 shows Lissajous patterns for various frequency ratios and phase shifts.

The XY measurement technique originated with analog oscilloscopes. DSOs may have difficulty creating real-time XY displays. Some DSOs create an XY image by accumulating triggered data points over time, then displaying two channels as an XY display.

DPOs, on the other hand, are able to acquire and display a genuine XY mode image in real-time, using a continuous stream of digitized data. DPOs can also display an XYZ image with intensified areas. Unlike XY displays on DSOs and DPOs, these displays on analog oscilloscopes are typically limited to a few megahertz of bandwidth.

## Other Measurement Techniques

This section has covered basic measurement techniques. Other measurement techniques involve setting up the oscilloscope to test electrical components on an assembly line, capturing elusive transient signals, and many others. The measurement techniques you will use will depend on your application, but you have learned enough to get started. Practice using your oscilloscope and read more about it. Soon its operation will be second nature to you.



## Written Exercises

This section contains written exercises that cover information in this primer. These are divided into two parts, Part I and Part II, with vocabulary and application exercises for each.

Check how well you have absorbed the information in these sections by verifying your responses against the answer key at the end of this section on page 54.

**Part I covers information presented in these sections:**

- The Oscilloscope
- Performance Terms and Considerations

**Part II covers information presented in sections:**

- The Systems and Controls of an Oscilloscope
- Operating the Oscilloscope
- Measurement Techniques

### Part I A: Vocabulary Exercise

**Write the letter of the definitions in the right column next to the correct words in the left column.**

Term	Definition
1. ___ Acquisition	<b>A</b> The unit of electric potential difference.
2. ___ Analog	<b>B</b> A performance measurement indicating the precision of an ADC, measured in bits.
3. ___ Bandwidth	<b>C</b> Term used when referring to degree points of a signal's period.
4. ___ Digital Phosphor	<b>D</b> The number of times a signal repeats in one second.
5. ___ Frequency	<b>E</b> The amount of time it takes a wave to complete one cycle.
6. ___ Glitch	<b>F</b> A stored digital value that represents the voltage of a signal at a specific point in time on the display.
7. ___ Period	<b>G</b> A common waveform shape that has a rising edge, a width, and a falling edge.
8. ___ Phase	<b>H</b> A performance measurement indicating the rising edge speed of a pulse.
9. ___ Pulse	<b>I</b> Oscilloscope circuitry that controls the timing of the sweep.
10. ___ Waveform Point	<b>J</b> An intermittent spike in a circuit.
11. ___ Rise Time	<b>K</b> A signal measured by an oscilloscope that only occurs once.
12. ___ Sample Point	<b>L</b> The oscilloscope's process of collecting sample points from the ADC, processing them, and storing them in memory.
13. ___ Digital Storage	<b>M</b> Something that operates with continuously changing values.
14. ___ Time Base	<b>N</b> Digital oscilloscope that captures 3 dimensions of signal information in real-time.
15. ___ Transient	<b>O</b> Digital oscilloscope with serial processing.
16. ___ ADC Resolution	<b>P</b> A sine wave frequency range, defined by the – 3 dB point.
17. ___ Volt	<b>Q</b> The raw data from an ADC used to calculate and display waveform points.

## Part I B: Application Exercise

**Circle the best answers for each statement. Some statements have more than one right answer.**

**1. With an oscilloscope you can:**

- a. Calculate the frequency of a signal.
- b. Find malfunctioning electrical components.
- c. Analyze signal details.
- d. All the above.

**2. The difference between analog and digitizing oscilloscopes is:**

- a. Analog oscilloscopes do not have on-screen menus.
- b. Analog oscilloscopes apply a measurement voltage directly to the display system, while digital oscilloscopes first convert the voltage into digital values.
- c. Analog oscilloscopes measure analogs, whereas digitizing oscilloscopes measure digits.
- d. Analog oscilloscopes do not have an acquisition system.

**3. An oscilloscope's vertical section does the following:**

- a. Acquires sample points with an ADC.
- b. Starts a horizontal sweep.
- c. Lets you adjust the brightness of the display.
- d. Attenuates or amplifies the input signal.

**4. The time base control of the oscilloscope does the following:**

- a. Adjusts the vertical scale.
- b. Shows you the current time of day.
- c. Sets the amount of time represented by the horizontal width of the screen.
- d. Sends a clock pulse to the probe.

**5. On an oscilloscope display:**

- a. Voltage is on the vertical axis and time is on the horizontal axis.
- b. A straight diagonal trace means voltage is changing at a steady rate.
- c. A flat horizontal trace means voltage is constant.
- d. All the above.

**6. All repeating waves have the following properties:**

- a. A frequency measured in Hertz.
- b. A period measured in seconds.
- c. A bandwidth measured in Hertz.
- d. All the above.

**7. If you probe inside a computer with an oscilloscope, you are likely to find the following types of signals:**

- a. Pulse trains.
- b. Ramp waves.
- c. Sine waves.
- d. All the above.

**8. When evaluating the performance of an analog oscilloscope, some things you might consider are:**

- a. The bandwidth.
- b. The vertical sensitivity.
- c. The ADC resolution.
- d. The sweep speed.

**9. The difference between digital storage oscilloscopes (DSO) and digital phosphor oscilloscopes (DPO) is:**

- a. The DSO has a higher bandwidth.
- b. The DPO captures three dimensions of waveform information in real-time.
- c. The DSO has a color display.
- d. The DSO captures more signal details.

## Part II A: Vocabulary Exercise

Write the letter of the definitions in the right column next to the correct words in the left column.

Term	Definition
1. ___ Averaging Mode	<b>A</b> The unintentional interaction of the probe and oscilloscope with the circuit being tested which distorts a signal.
2. ___ Circuit Loading	<b>B</b> A conductor that connects electrical currents to the Earth.
3. ___ Compensation	<b>C</b> A sampling mode in which the digital oscilloscope collects as many samples as it can as the signal occurs, then constructs a display, using interpolation if necessary.
4. ___ Coupling	<b>D</b> A sampling mode in which the digital oscilloscope constructs a picture of a repetitive signal by capturing a little bit of information from each repetition.
5. ___ Earth Ground	<b>E</b> A device that converts a specific physical quantity such as sound, pressure, strain, or light intensity into an electrical signal.
6. ___ Equivalent-Time	<b>F</b> A test device for injecting a signal into a circuit input.
7. ___ Graticule	<b>G</b> A processing technique used by digital oscilloscopes to eliminate noise in a displayed signal.
8. ___ Interpolation	<b>H</b> The method of connecting two circuits together.
9. ___ Real Time	<b>I</b> A “connect-the-dots” processing technique to estimate what a fast waveform looks like based on only a few sampled points.
10. ___ Signal Generator	<b>J</b> The grid lines on a screen for measuring oscilloscope traces.
11. ___ Single Sweep	<b>K</b> A trigger mode that triggers the sweep once, must be reset to accept another trigger event.
12. ___ Sensor	<b>L</b> A probe adjustment for 10X attenuator probes that balances the electrical properties of the probe with the electrical properties of the oscilloscope.

## Part II B: Application Exercise

**Circle the best answers for each statement. Some statements have more than one right answer.**

**1. To operate an oscilloscope safely, you should:**

- a. Ground the oscilloscope with the proper three-pronged power cord.
- b. Learn to recognize potentially dangerous electrical components.
- c. Avoid touching exposed connections in a circuit being tested even if the power is off.
- d. All the above.

**2. Grounding an oscilloscope is necessary:**

- a. For safety reasons.
- b. To provide a reference point for making measurements.
- c. To align the trace with the screen's horizontal axis.
- d. All the above.

**3. Circuit loading is caused by:**

- a. An input signal having too large a voltage.
- b. The probe and oscilloscope interacting with the circuit being tested.
- c. A 10X attenuator probe being uncompensated.
- d. Putting too much weight on a circuit.

**4. Compensating a probe is necessary to:**

- a. Balance the electrical properties of the 10X attenuator probe with the oscilloscope.
- b. Prevent damaging the circuit being tested.
- c. Improve the accuracy of your measurements.
- d. All the above.

**5. The trace rotation control is useful for:**

- a. Scaling waveforms on the screen.
- b. Detecting sine wave signals.
- c. Aligning the waveform trace with the screen's horizontal axis on an analog oscilloscope.
- d. Measuring pulse width.

**6. The volts per division control is used to:**

- a. Scale a waveform vertically.
- b. Position a waveform vertically.
- c. Attenuate or amplify an input signal.
- d. Set the numbers of volts each division represents.

**7. Setting the vertical input coupling to ground does the following:**

- a. Disconnects the input signal from the oscilloscope.
- b. Causes a horizontal line to appear with auto trigger.
- c. Lets you see where zero volts is on the screen.
- d. All the above.

**8. The trigger is necessary to:**

- a. Stabilize repeating waveforms on the screen.
- b. Capture single-shot waveforms.
- c. Mark a particular point of an acquisition.
- d. All the above.

**9. The difference between auto and normal trigger mode is:**

- a. In normal mode the oscilloscope only sweeps once and then stops.
- b. In normal mode the oscilloscope only sweeps if the input signal reaches the trigger point; otherwise the screen is blank.
- c. Auto mode makes the oscilloscope sweep continuously even without being triggered.
- d. All the above.

**10. The acquisition mode that best reduces noise in a repeating signal is:**

- a. Sample mode.
- b. Peak detect mode.
- c. Envelope mode.
- d. Averaging mode.

**11. The two most basic measurements you can make with an oscilloscope are:**

- a. Time and frequency measurements.
- b. Time and voltage measurements.
- c. Voltage and pulse width measurements.
- d. Pulse width and phase shift measurements.

**12. If the volts/division is set at 0.5, the largest signal that can fit on the screen (assuming an 8 x 10 division screen) is:**

- a. 62.5 millivolts peak-to-peak.
- b. 8 volts peak-to-peak.
- c. 4 volts peak-to-peak.
- d. 0.5 volts peak-to-peak.

**13. If the seconds/division is set at 0.1 ms, the amount of time represented by the width of the screen is:**

- a. 0.1 ms.
- b. 1 ms.
- c. 1 second.
- d. 0.1 kHz.

**14. By convention, pulse width is measured:**

- a. At 10% of the pulse's peak-to-peak (pk-pk) voltage.
- b. At 50% of the pulse's peak-to-peak (pk-pk) voltage.
- c. At 90% of the pulse's peak-to-peak (pk-pk) voltage.
- d. At 10% and 90% of the pulse's peak-to-peak (pk-pk) voltage.

**15. You attach a probe to your test circuit but the screen is blank. You should:**

- a. Check that the screen intensity is turned up.
- b. Check that the oscilloscope is set to display the channel that the probe is connected to.
- c. Set the trigger mode to auto since norm mode blanks the screen.
- d. Set the vertical input coupling to AC and set the volts/division to its largest value since a large DC signal may go off the top or bottom of the screen.
- e. Check that the probe isn't shorted and make sure it is properly grounded.
- f. Check that the oscilloscope is set to trigger on the input channel you are using.
- g. All of the above.

## Answer Key

This section provides the answers to all written exercises in the previous section.

### Part IA: Vocabulary Exercise Answers

1. L	5. D	9. G	13. O
2. M	6. J	10. F	14. I
3. P	7. E	11. H	15. K
4. N	8. C	12. Q	16. B
			17. A

### Part IB: Application Exercise Answers

1. D	3. D	5. D	7. A
2. B,D	4. C	6. A,B	8. A,B,D
			9. B

### Part IIA: Vocabulary Exercise Answers

1. G	4. H	7. J	10. F
2. A	5. B	8. I	11. K
3. L	6. D	9. C	12. E

### Part IIB: Application Exercise Answers

1. D	5. C	9. B,C	13. B
2. A,B	6. A,C,D	10. D	14. B
3. B	7. D	11. B	15. G
4. A,C	8. D	12. C	

## Glossary

### A

**Acquisition Mode** – Modes that control how waveform points are produced from sample points. Some types include sample, peak detect, hi res, envelope, average, and waveform data base.

**Alternating Current (AC)** – A signal in which the current and voltage vary in a repeating pattern over time. Also used to indicate signal coupling type.

**Amplification** – An increase in signal amplitude during its transmission from one point to another.

**Amplitude** – The magnitude of a quantity or strength of a signal. In electronics, amplitude usually refers to either voltage or power.

**Analog-to-Digital Converter (ADC)** – A digital electronic component that converts an electrical signal into discrete binary values.

**Analog Oscilloscope** – An instrument that creates a waveform display by applying the input signal (conditioned and amplified) to the vertical axis of an electron beam moving across a cathode-ray tube (CRT) screen horizontally from left to right. A chemical phosphor coated on the CRT creates a glowing trace wherever the beam hits.

**Analog Signal** – A signal with continuously variable voltages.

**Attenuation** – A decrease in signal amplitude during its transmission from one point to another.

**Averaging** – A processing technique used by digital oscilloscopes to reduce noise in a displayed signal.

### B

**Bandwidth** – A frequency range, usually limited by  $-3$  dB.

### C

**Circuit Loading** – The unintentional interaction of the probe and oscilloscope with the circuit being tested, distorting the signal.

**Compensation** – A probe adjustment for passive attenuation probes that balances the capacitance of the probe with the capacitance of the oscilloscope.

**Coupling** – The method of connecting two circuits together. Circuits connected with a wire are directly coupled (DC); circuits connected through a capacitor or transformer are indirectly (AC) coupled.

**Cursor** – An on-screen marker that you can align with a

waveform to make more accurate measurements.

### D

**Delayed Time Base** – A time base with a sweep that can start (or be triggered to start) relative to a pre-determined time on the main time base sweep. Allows you to see events more clearly and to see events that are not visible solely with the main time base sweep.

**Digital Signal** – A signal whose voltage samples are represented by discrete binary numbers.

**Digital Oscilloscope** – A type of oscilloscope that uses an analog-to-digital converter (ADC) to convert the measured voltage into digital information. Types include: digital storage, digital phosphor, mixed signal, and digital sampling oscilloscopes.

**Digital Phosphor Oscilloscope (DPO)** – A type of digital oscilloscope that closely models the display characteristics of an analog oscilloscope while providing traditional digital oscilloscope benefits (waveform storage, automated measurements, etc.) The DPO uses a parallel-processing architecture to pass the signal to the raster-type display, which provides intensity-graded viewing of signal characteristics in real time. The DPO displays signals in three dimensions: amplitude, time and the distribution of amplitude over time.

**Digital Sampling Oscilloscope** – A type of digital oscilloscope that employs equivalent-time sampling method to capture and display samples of a signal, ideal for accurately capturing signals whose frequency components are much higher than the oscilloscope's sample rate.

**Digital Signal Processing** – The application of algorithms to improve the accuracy of measured signals.

**Digital Storage Oscilloscope (DSO)** – A digital oscilloscope that acquires signals via digital sampling (using an analog-to-digital converter). It uses a serial-processing architecture to control acquisition, user interface, and the raster display.

**Digitize** – The process by which an analog-to-digital converter (ADC) in the horizontal system samples a signal at discrete points in time and converts the signal's voltage at these points into digital values called sample points.

**Direct Current (DC)** – A signal with a constant voltage and/or current. Also used to indicate signal coupling type.

**Division** – Measurement markings on the oscilloscope graticule indicating major and minor marks.

## E

**Earth Ground** – A conductor that will connect electrical currents to the Earth.

**Effective Bits** – A measure of a digital oscilloscope's ability to accurately reconstruct a sine wave signal's shape. This measurement compares the oscilloscope's actual error to that of a theoretical “ideal” digitizer.

**Envelope** – The outline of a signal's highest and lowest points acquired over many displayed waveform repetitions.

**Equivalent-time Sampling** – A sampling mode in which the oscilloscope constructs a picture of a repetitive signal by capturing a little bit of information from each repetition. Two types of equivalent-time sampling: random and sequential.

## F

**Focus** – The analog oscilloscope control that adjusts the cathode-ray tube (CRT) electron beam to control the sharpness of the display.

**Frequency** – The number of times a signal repeats in one second, measured in Hertz (cycles per second). The frequency equals 1/period.

**Frequency Response** – Frequency response curves of an oscilloscope define the accuracy in amplitude representation of the input signal in function of the signal's frequency. In order to obtain maximum signal fidelity, it is important that the oscilloscope has a flat (stable) frequency response across the entire specified oscilloscope's bandwidth.

## G

**Gain Accuracy** – An indication of how accurately the vertical system attenuates or amplifies a signal, usually represented as a percentage error.

**Gigahertz (GHz)** – 1,000,000,000 Hertz; a unit of frequency.

**Glitch** – An intermittent, high-speed error in a circuit.

**Graticule** – The grid lines on a display for measuring oscilloscope traces.

**Ground** –

1. A conducting connection by which an electric circuit or equipment is connected to the earth to establish and maintain a reference voltage level.
2. The voltage reference point in a circuit.

## H

**Hertz (Hz)** – One cycle per second; the unit of frequency.

**Horizontal Accuracy (Time Base)** – An indication of how accurately the horizontal system displays the timing of a signal, usually represented as a percentage error.

**Horizontal Sweep** – The action of the horizontal system that causes a waveform to be drawn.

## I

**Intensity Grading** – Frequency-of-occurrence information that is essential to understanding what the waveform is really doing.

**Interpolation** – A “connect-the-dots” processing technique to estimate what a fast waveform looks like based on only a few sampled points. Two types: linear and sin x/x.

## K

**Kilohertz (kHz)** – 1,000 Hertz; a unit of frequency.

## L

**Loading** – The unintentional interaction of the probe and oscilloscope with the circuit being tested which distorts a signal.

**Logic Analyzer** – An instrument used to make the logic states of many digital signals visible over time. It analyzes the digital data and can represent the data as real-time software execution, data flow values, state sequences, etc.

## M

**Megahertz (MHz)** – 1,000,000 Hertz; a unit of frequency.

**Megasamples per second (MS/s)** – A sample rate unit equal to one million samples per second.

**Microsecond (μs)** – A unit of time equivalent to 0.000001 seconds.

**Millisecond (ms)** – A unit of time equivalent to 0.001 seconds.

**Mixed Signal Oscilloscope (MSO)** – A type of digital oscilloscope that combines the basic functionality of a 16-channel logic analyzer with the trusted performance of a 4-channel digital phosphor oscilloscope.



## N

**Nanosecond (ns)** – A unit of time equivalent to 0.00000001 seconds.

**Noise** – An unwanted voltage or current in an electrical circuit.

## O

**Oscilloscope** – An instrument used to make voltage changes visible over time. The word oscilloscope comes from “oscillate,” since oscilloscopes are often used to measure oscillating voltages.

## P

**Peak ( $V_p$ )** – The maximum voltage level measured from a zero reference point.

**Peak Detection** – An acquisition mode available with digital oscilloscopes that enables you to observe signal details that may otherwise be missed, particularly useful for seeing narrow pulses spaced far apart in time.

**Peak-to-peak ( $V_{p-p}$ )** – The voltage measured from the maximum point of a signal to its minimum point.

**Period** – The amount of time it takes a wave to complete one cycle. The period equals 1/frequency.

**Phase** – The amount of time that passes from the beginning of a cycle to the beginning of the next cycle, measured in degrees.

**Phase Shift** – The difference in timing between two otherwise similar signals.

**Pre-trigger Viewing** – The ability of a digital oscilloscope to capture what a signal did before a trigger event. Determines the length of viewable signal both preceding and following a trigger point.

**Probe** – An oscilloscope input device, usually having a pointed metal tip for making electrical contact with a circuit element, a lead to connect to the circuit’s ground reference, and a flexible cable for transmitting the signal and ground to the oscilloscope.

**Pulse** – A common waveform shape that has a fast rising edge, a width, and a fast falling edge.

**Pulse Train** – A collection of pulses traveling together.

**Pulse Width** – The amount of time the pulse takes to go from low to high and back to low again, conventionally measured at 50% of full voltage.

## R

**Ramps** – Transitions between voltage levels of sine waves that change at a constant rate.

**Raster** – A type of display.

**Real-time Sampling** – A sampling mode in which the oscilloscope collects as many samples as possible from one triggered acquisition. Ideal for signals whose frequency range is less than half the oscilloscope’s maximum sample rate.

**Record Length** – The number of waveform points used to create a record of a signal.

**Rise Time** – The time taken for the leading edge of a pulse to rise from its low to its high values, typically measured from 10% to 90%.

## S

**Sampling** – The conversion of a portion of an input signal into a number of discrete electrical values for the purpose of storage, processing and/or display by an oscilloscope. Two types: real-time sampling and equivalent-time sampling.

**Sample Point** – The raw data from an ADC used to calculate waveform points.

**Sample Rate** – Refers to how frequently a digital oscilloscope takes a sample of the signal, specified in samples per second (S/s).

**Sensor** – A device that converts a specific physical quantity such as sound, pressure, strain, or light intensity into an electrical signal.

**Signal Integrity** – The accurate reconstruction of a signal, determined by the systems and performance considerations of an oscilloscope, in addition to the probe used to acquire the signal.

**Signal Source** – A test device used to inject a signal into a circuit input; the circuit’s output is then read by an oscilloscope. Also known as a signal generator.

**Sine Wave** – A common curved wave shape that is mathematically defined.

**Single Shot** – A signal measured by an oscilloscope that only occurs once (also called a transient event).

**Single Sweep** – A trigger mode to display one triggered screen of a signal and then stop.

**Slope** – On a graph or an oscilloscope display, the ratio of a vertical distance to a horizontal distance. A positive slope increases from left to right, while a negative slope decreases from left to right.

**Square Wave** – A common wave shape consisting of repeating square pulses.

**Sweep** – One horizontal pass of an analog oscilloscope's electron beam from left to right across the CRT screen.

**Sweep Speed** – Same as the time base.

## T

**Time Base** – Oscilloscope circuitry that controls the timing of the sweep. The time base is set by the seconds/division control.

**Trace** – The visible shapes drawn on a CRT by the movement of the electron beam.

**Transient** – A signal measured by an oscilloscope that only occurs once (also called a single-shot event).

**Trigger** – The circuit that references a horizontal sweep on an oscilloscope.

**Trigger Holdoff** – A control that allows you to adjust the period of time after a valid trigger during which the oscilloscope cannot trigger.

**Trigger Level** – The voltage level that a trigger source signal must reach before the trigger circuit initiates a sweep.

**Trigger Mode** – A mode that determines whether or not the oscilloscope draws a waveform if it does not detect a trigger. Common trigger modes include normal and auto.

**Trigger Slope** – The slope that a trigger source signal must reach before the trigger circuit initiates a sweep.

## V

**Vertical Resolution (Analog-to-Digital Converter)** –

An indication of how precisely an analog-to-digital converter (ADC) in a digital oscilloscope can convert input voltages into digital values, measured in bits. Calculation techniques, such as hi res acquisition mode, can improve the effective resolution.

**Vertical Sensitivity** – An indication of how much the vertical amplifier can amplify a weak signal – usually measured in millivolts (mV) per division.

**Volt** – The unit of electric potential difference.

**Voltage** – The difference in electric potential, expressed in volts, between two points.

## W

**Wave** – The generic term for a pattern that repeats over time. Common types include: sine, square, rectangular, sawtooth, triangle, step, pulse, periodic, non-periodic, synchronous, asynchronous.

**Waveform** – A graphic representation of a voltage varying over time.

**Waveform Capture Rate** – Refers to how quickly an oscilloscope acquires waveforms, expressed as waveforms per second (wfms/s).

**Waveform Point** – A digital value that represents the voltage of a signal at a specific point in time. Waveform points are calculated from sample points and stored in memory.

**Writing Speed** – The ability of an analog oscilloscope to provide a visible trace of the movement of a signal from one point to another. This ability is restrictive for low-repetition signals that have fast-moving details, such as digital logic signals.

**XY Mode** – A measurement technique that involves inputting one signal into the vertical system, as usual, and one into the horizontal system to trace voltages on both the X and Y axis.

## Z

**Z Axis** – The display attribute on an oscilloscope that shows brightness variations as the trace is formed.



## Contact Tektronix:

**ASEAN / Australasia** (65) 6356 3900  
**Austria** 00800 2255 4835\*  
**Balkans, Israel, South Africa and other ISE Countries** +41 52 675 3777  
**Belgium** 00800 2255 4835\*  
**Brazil** +55 (11) 3759 7600  
**Canada** 1 (800) 833-9200  
**Central East Europe, Ukraine and the Baltics** +41 52 675 3777  
**Central Europe & Greece** +41 52 675 3777  
**Denmark** +45 80 88 1401  
**Finland** +41 52 675 3777  
**France** 00800 2255 4835\*  
**Germany** 00800 2255 4835\*  
**Hong Kong** 400-820-5835  
**India** (91) 80-42922600  
**Italy** 00800 2255 4835\*  
**Japan** 81 (3) 6714-3010  
**Luxembourg** +41 52 675 3777  
**Mexico, Central/South America & Caribbean** 52 (55) 53 35 10 85  
**Middle East, Asia and North Africa** +41 52 675 3777  
**The Netherlands** 00800 2255 4835\*  
**Norway** 800 16098  
**People's Republic of China** 400-820-5835  
**Poland** +41 52 675 3777  
**Portugal** 80 08 12370  
**Republic of Korea** 82 (2) 6917-5000  
**Russia & CIS** +7 (495) 7484900  
**South Africa** +27 11 206 8360  
**Spain** 00800 2255 4835\*  
**Sweden** 00800 2255 4835\*  
**Switzerland** 00800 2255 4835\*  
**Taiwan** 886 (2) 2722-9622  
**United Kingdom & Ireland** 00800 2255 4835\*  
**USA** 1 (800) 833-9200

\* European toll-free number. If not accessible, call: +41 52 675 3777

Contact List Updated 09 December 2009

### For Further Information

Tektronix maintains a comprehensive, constantly expanding collection of application notes, technical briefs and other resources to help engineers working on the cutting edge of technology. Please visit [www.tektronix.com](http://www.tektronix.com)



Copyright © 2009, Tektronix. All rights reserved. Tektronix products are covered by U.S. and foreign patents, issued and pending. Information in this publication supersedes that in all previously published material. Specification and price change privileges reserved. TEKTRONIX and TEK are registered trademarks of Tektronix, Inc. All other trade names referenced are the service marks, trademarks or registered trademarks of their respective companies.

12/09 JS  
TEK1511

03W-8605-5

**Tektronix**<sup>®</sup>

