

Introduction to Solar Trackers

There are many useful solar energy applications which can benefit from tracking the motion of the sun across the sky, such as optically focused solar collectors. The daily motion of the sun traces out a simple arc, which can be tracked with a single axis of mechanical motion... usually through some arrangement of electric motor and drive train. This booklet explains the basic principles of tracking the sun and presents several examples of mechanical mounts. This booklet also describes several simple electrical circuits capable of controlling a DC motor or linear actuator for the tracking. The solar tracker circuits are simple and effective, and they resets the tracker to the East at the end of the day.

Basic Solar Tracking Mounts

Tracking an object's motion across the sky has been the basic challenge of astronomy for centuries, and not surprisingly, some clever solutions to the problem have been devised.

A very basic type of tracking system is the Altitude-Azimuth mount. An example of a telescope mounted this way is shown in Figure 1. It consists of a yoke which can rotate around a vertical axis. The telescope is mounted inside the yoke and can be aimed with respect to the horizontal. This mount is mechanically simple to build, but the arrangement is cumbersome to use in practice. That's because tracking the sun requires continuous adjustment in two directions; horizontal and vertical. The frequency of adjustment depends on where the object is in the sky, and the adjustments are not a simple continuous motion.

Astronomers quickly improved on this basic arrangement to create the Equatorial mount. If the vertical axis of the Altitude-Azimuth mount is aimed parallel to the axis of the earth's rotation the tracking motion becomes greatly simplified. With an Equatorial mount the sun will be tracked with only one simple continuous motion. In the Northern hemisphere, pointing the rotational axis at the North Star will align it correctly for tracking the sun. Figure 1 shows how an altitude-azimuth becomes an Equatorial mount. Figure 2 shows how the alignment angle is specified, with some examples.

The Equatorial mount can be motorized to track celestial objects, since the rate of motion is approximately one revolution every 24 hours. A constant RPM AC synchronous motor connected to a mechanical gear train is called a "clock drive". Clock drives have reached a high degree of development for telescopes, but unfortunately they are expensive and require user input to point at the sun.

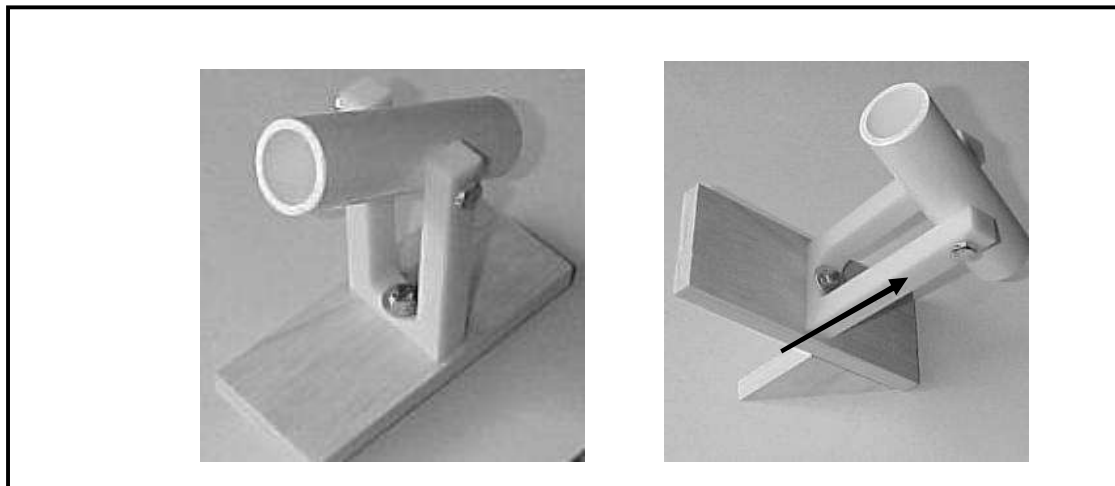

Figure 1. A basic Altitude-Azimuth mount becomes a single axis tracking Equatorial mount by aligning one axis to the North Star.

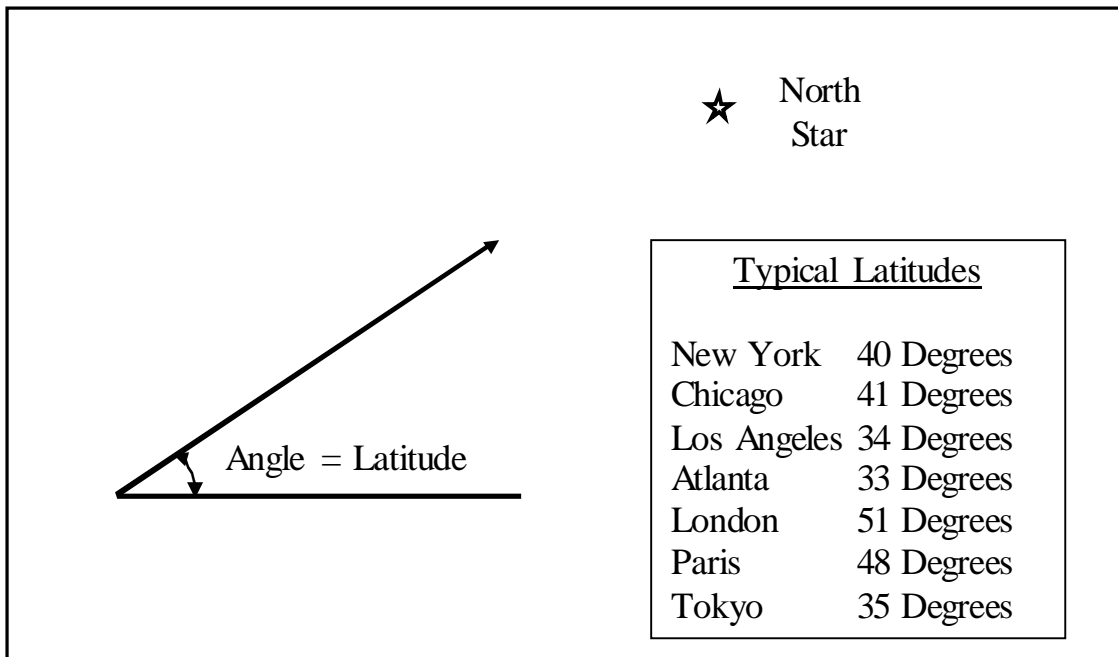

Figure 2. The angle of the single axis solar tracker with respect to the horizontal is equal to the latitude of your location.

The photographs in Figure 3 show two good examples of mechanical hardware for tracking. The first is an Equatorial Telescope mount, and the second is a mount for a large television satellite dish.

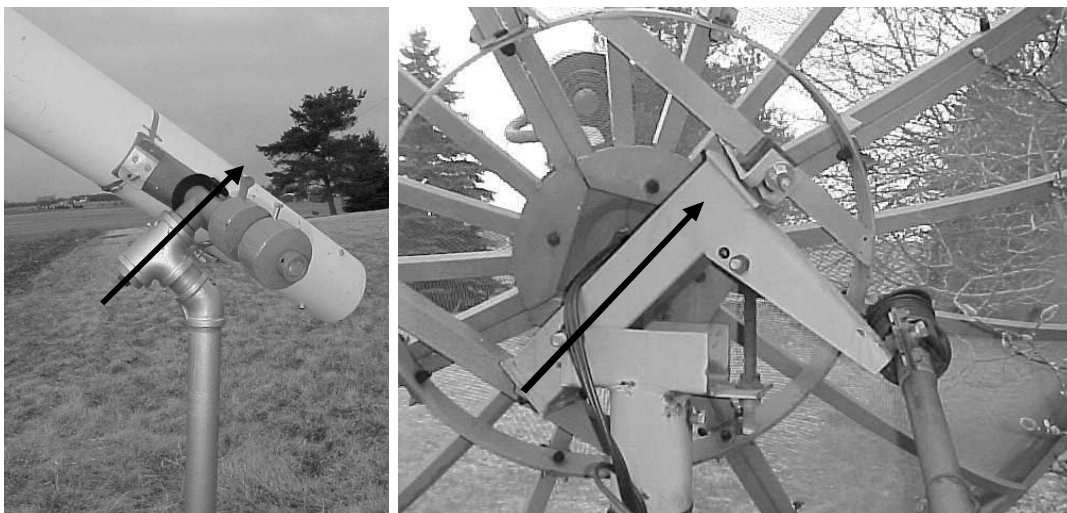

Figure 3. Examples of mechanical mounts aligned to the polar axis.

Benefit of Solar Tracking: Simple Example

The benefit of tracking the sun can be calculated directly for a simple example. Consider a flat plate collector located at the equator of the Earth. Everyday is the same at the equator: the sun rises at 6 AM, is directly overhead at noon, and sets at 6 PM. As shown in Figure 4, a stationary flat plate collector receives the full sun at noon, but the fixed collector receives no sun at dawn or sunset because of the angle of approaching light. In comparison, solar tracking of the collector provides full sunlight during all 12 hours of daylight. The amount of sunlight collected for a stationary collector varies as the sine of the angle of the sun position, and the total sunlight received is the integral over the course of the day. The net result is that a tracking flat plate collector will receive approximately 59% more sunlight than a stationary collector. In practice the benefit will be less because the early and late sunlight is less intense, having traveled through more of the Earth’s atmosphere before reaching the collector.

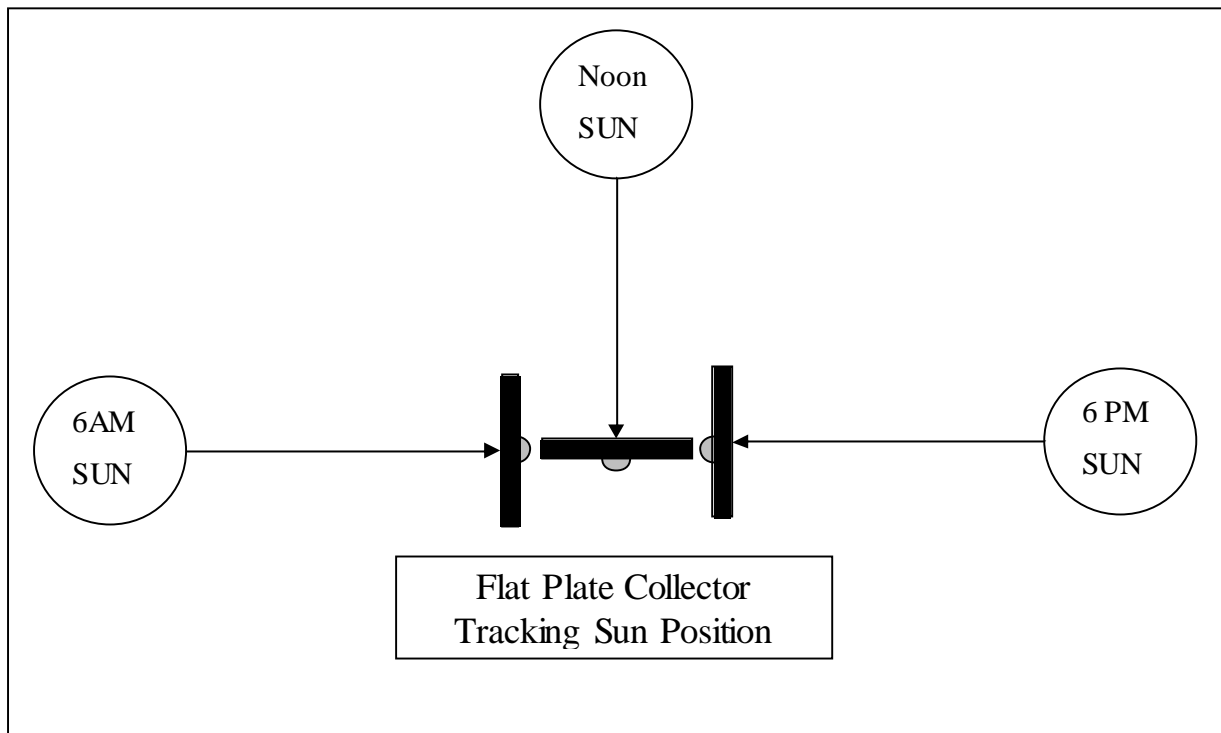

Figure 4. Simple example of Solar Tracking Benefits

Feedback Control

Tracking systems for astronomy must be able to follow faint stars. However, the sun is a very bright object and we can use the sunlight to actuate sensors for automatic tracking. This is called feedback control.

An electronic tracking system must sense if bright sunshine exists, and where in the sky the sun is physically located. With that information, the tracking system can send the signal to actuate a motor to move in the proper direction. As it turns out, a relatively simple tracking system circuit is able to accomplish this task.

Figure 5 shows the details of a basic solar tracking system. It consists of two CdS photocell sensors mounted on opposite sides of a central divider. The divider, referred to as a shadow block, is arranged such that it can cast a shadow on the sensors, depending on the position of the sun. With regards to the divider, the sun can only be in one of 3 positions: Position 1: East of Center, Position 2: Centered, or Position 3: West of Center.

Referring again to Figure 4: If the sun is in Position 1 (East of Center), then the East Photocell will be in bright sunlight and the West Photocell will be shadowed. The tracker system sends the signal “Move to the East”. In the same way, if the sun is in Position 3 (West of Center), the West Photocell will be in bright sunlight and the tracker sends the signal “Move to the West”. Finally, if the sun is in Position 2 (Centered), both Photocells will be in bright sunlight and the tracker sends the signal “Don’t Move”.

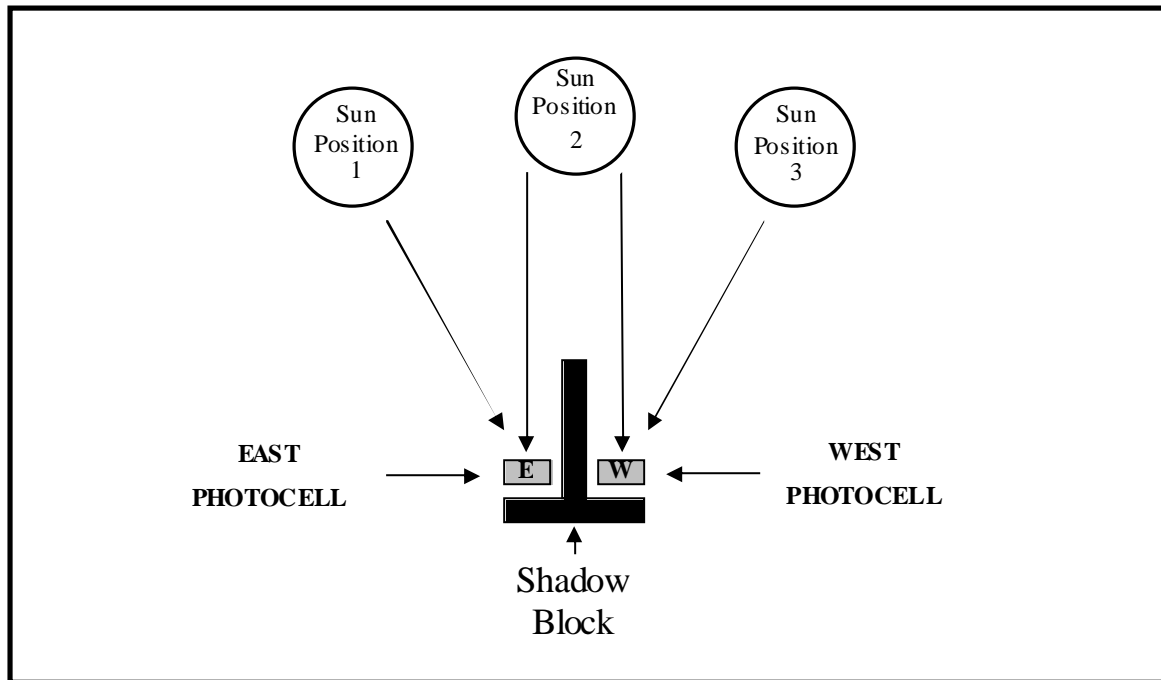

Figure 5. This is the basic layout of a solar tracker with feedback control.

In this type of solar tracker the pointing accuracy is controlled by the height of the shadow block. When the block is made taller, the shadow it casts will move faster and actuate the controller more often, resulting in more precise aiming. A good starting height for a shadow block is about 3 inches (7.6 cm).

The shadow block concept can be implemented on your project using existing hardware. It is only necessary to find a planar part of the tracker structure which points at the sun during alignment. Figure 6 shows an example of the sensors mounted on opposite sides of a mechanical support bar, hence in this case it was not necessary to build an actual shadow block.

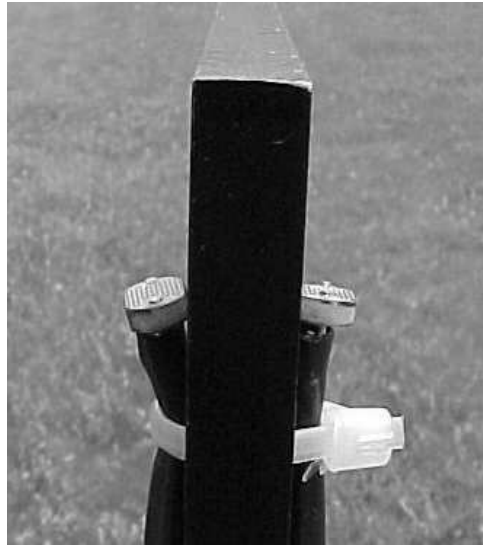
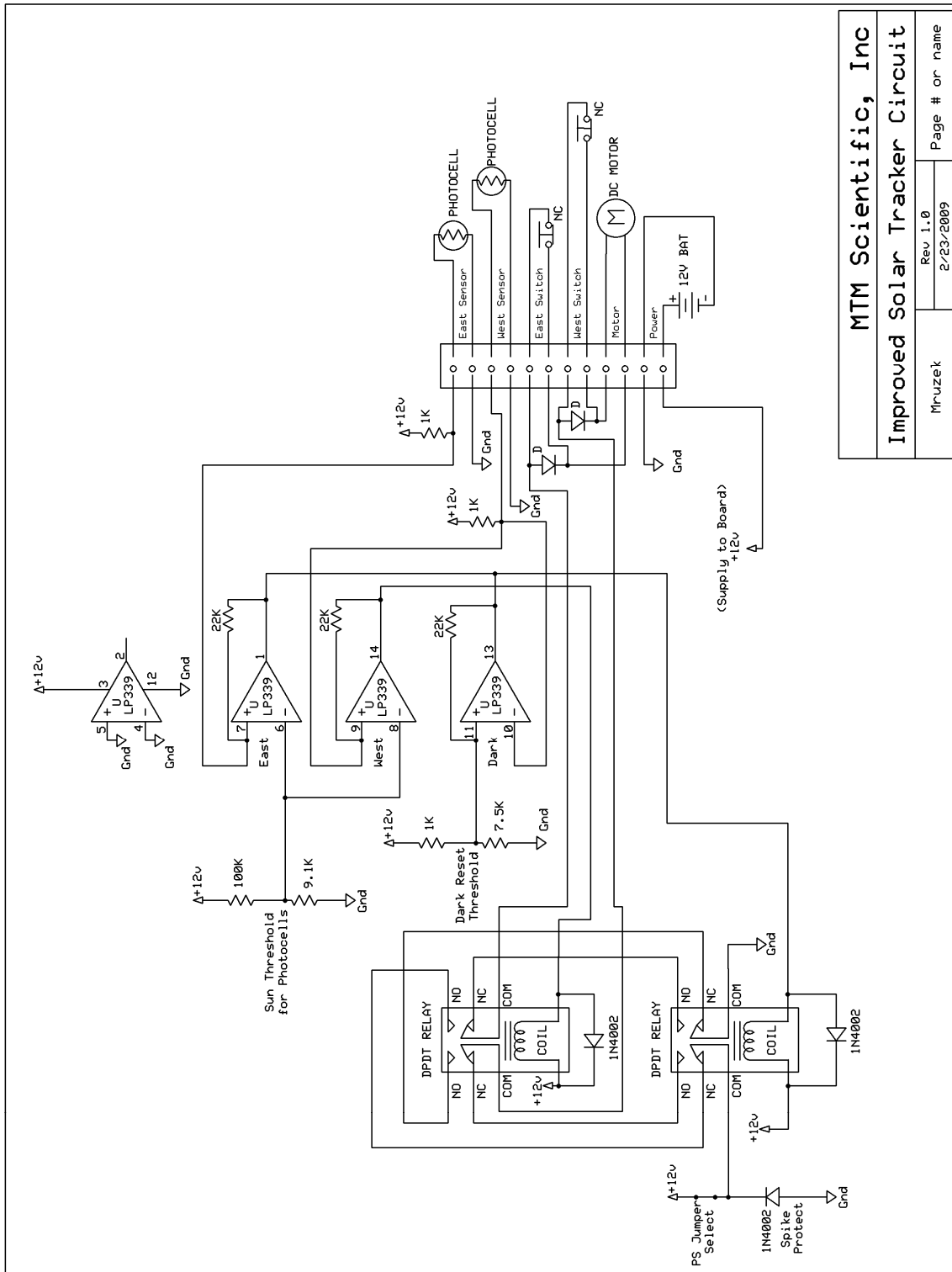

Figure 6. Sun sensors mounted on opposite sides of tracker structure.

Circuit Details

The basic circuit for sensing and actuating a DC motor or actuator (usually 12 VDC) to follow the motion of the sun along a single axis is shown in Figure 7. This circuit is built using 9 resistors, 2 photosensors, 5 diodes, 2 limit switches, 1 integrated circuit comparator and 2 miniature relays. Figure 7 shows the circuit diagram. A photograph of the same circuit, assembled on the printed circuit board, is shown in Figure 8.

In the circuit, the East and West photocells are each connected in series with a 1K Ohm resistor to form voltage dividers. When either photocell is exposed to light the resistance is reduced, and consequently the voltage from the divider will also be reduced. The "trigger point" for each comparator is set by the fixed voltage divider, made with the 100K Ohm and 9.1K Ohm resistors. The LM339 IC comparator senses the voltages from the photocells, compares the voltage to the threshold reference and makes a decision about tripping the H-bridge relays to move the tracker.



MTM Scientific, Inc	
Improved Solar Tracker Circuit	
Mr.uzek	Page # or name
Rev 1.0	2/23/2009

Figure 7. Circuit diagram of the standard MTM Solar Tracker

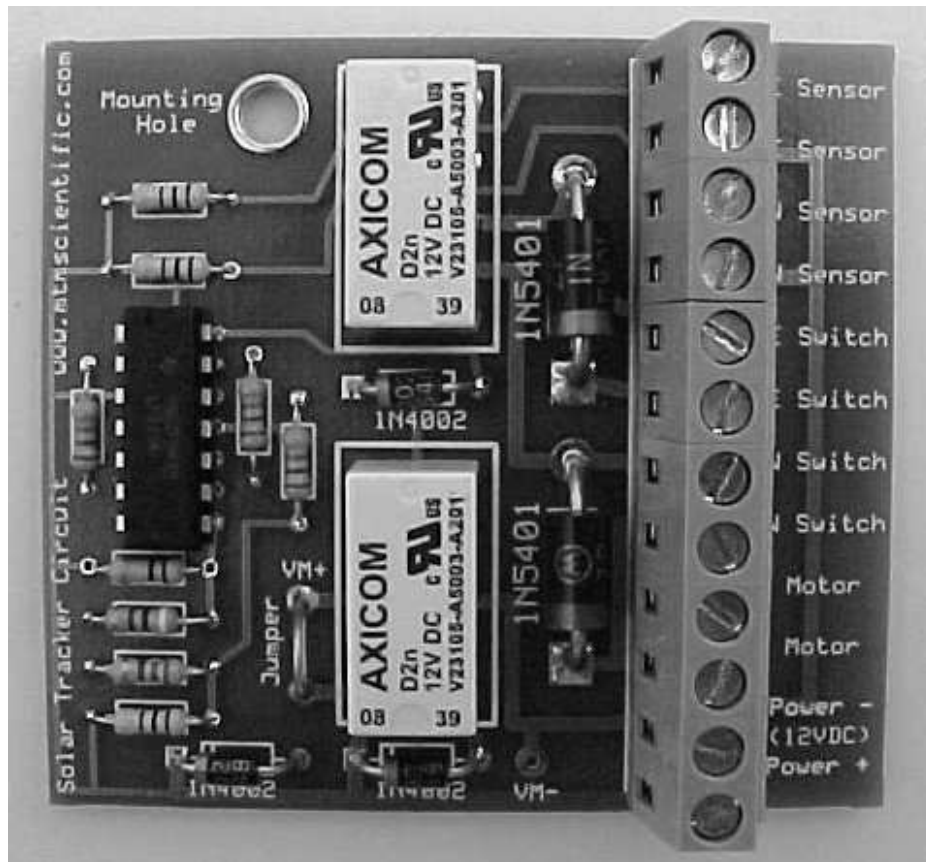

Figure 8. Photograph of the assembled Solar Tracker circuit board kit.

In a control system such as this, undesirable behavior can occur when the system is very close to the trigger point. For example, the motor could erratically switch on-and-off as the sensor voltage dithers near the threshold set point. This potential problem is solved by providing something called positive feedback. The positive feedback in the tracker circuit is provided by the 22K Ohm resistors. These resistors provide a damping action known as hysteresis.

This circuit is designed to operate on 12 VDC, although in practice the voltage can vary by a few volts up or down. The voltage rating of the coil inside the relays is what determines the allowable voltage range. Also, since the relays are rated at 3

amps maximum current, the relays also determine the maximum allowed current draw for the DC motor or actuator.

Most applications using this kit will be with a 12 VDC motor. When using 12 VDC there is a soldered jumper on the circuit that must be installed, as shown in Figure 9. The jumper provides the 12 VDC power to the motor.

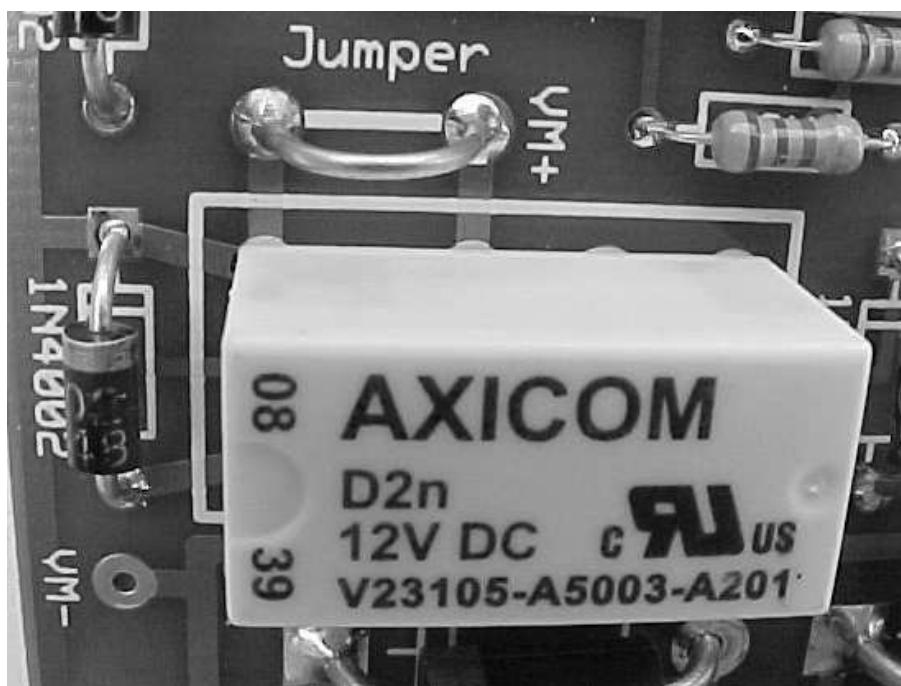

Figure 9. Install the jumper on the board if you are using a 12 VDC motor.

The circuit can be used with motors with a voltage different than 12 VDC. In such cases do not install the jumper. Instead, connect the positive (+) lead of the motor power supply to the terminal marked VM+. The negative (-) lead of the motor power supply is connected to the terminal marked VM- (Visible in the lower left hand corner of Figure 9.) The circuit board must always have a 12 VDC power supply for the electronics, regardless of what voltage is being used for the motor.

The circuit board and electronic components of the kit must be assembled. Kit assembly requires using a fine tip soldering iron with electronic rosin core solder. If you are not familiar with electronic soldering there is a helpful tutorial available on the MTM website.

During assembly, all the components are mounted on the top side of the circuit board. Install the IC chip with the notches aligned as shown in Figure 10. Installing the chip upside down will damage the chip permanently. Also note that the green terminal block connectors are designed to slide together to form an assembly, as shown in Figure 11.

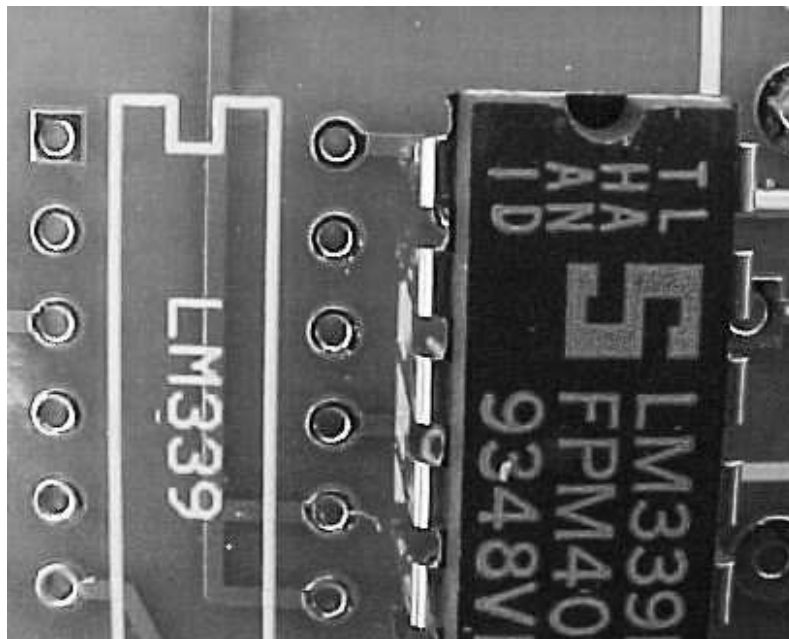

Figure 10. Install the IC chip so the top notch is aligned with the artwork outline.

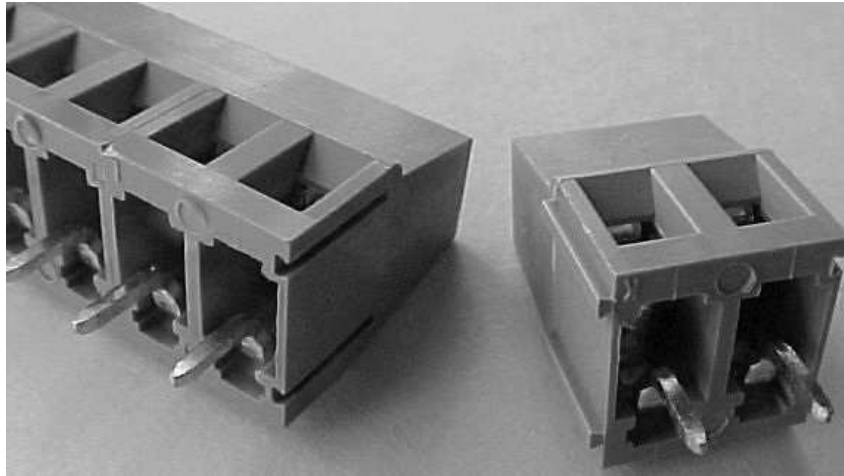

Figure 11. Note that the terminal blocks slide together using the side notches. Assemble the blocks together before soldering them to the board.

The tracker follows the sun all day until sunset. The West limit switch stops the motion. This tracker circuit has been designed with a special feature: The tracker will reset the tracker position to the East at the end of the day, after it becomes dark. The circuit monitors the West sensor and compares the signal to a dark threshold voltage, as shown in the schematic of Figure 7.

The tracking circuit can be assembled on the printed circuit board, but bench testing should be done outdoors in bright sunlight with a shadow block. Do not take shortcuts when testing: Install the limit switches! If you have a multimeter, check the voltage and polarity of the 12 VDC power supply before connecting it to the circuit board. ***Connecting a reversed polarity power supply connection will damage the circuit beyond repair.*** For testing, the output of the circuit can be wired to your motor, or you can use a multimeter to monitor the voltage output to the motor terminals. (Actually, you can hear the relays switching with no load if you listen carefully.) Proceed with the testing by exposing one of the photocells on the shadow block to direct sunlight. Bright sunlight applied to one photocell



with the other photocell shaded will actuate the relays and send 12V output to the motor connections. The motor output polarity will switch (+/-) depending on which photocell is in the sunlight.

One of the key challenges to having this circuit work properly is to avoid making the circuit overly sensitive to light. The trip point for the sunlight sensors is set by the 9.1K Ohm resistor in the circuit. A higher resistance value will make the circuit more sensitive to sunlight. If you would like to make the sensitivity adjustable, replace the 9.1K Ohm resistor with a multiple turn potentiometer. Note: If the sensitivity is set too high the circuit will trip on a false signals, such as hazy diffuse sunlight or reflections, and the erratic movements will continue until a limit switch is hit. If the sensitivity is set too low, the tracker will not move at all. The sensors are tested and matched as pairs for the kits and they should perform well in this circuit without any adjustment. Normal resistance in sunlight is about 65 ohms for the sensors.

Once you are satisfied with the operation of the circuit, and if you don't plan on making any more changes, it is a good idea to mount the circuit board in a weatherproof enclosure. The circuit board is small enough to be mounted inside a standard watertight outdoor junction box, as shown in Figure 12. Standard applications with a 12 VDC motor will have six pairs of wires attached to the circuit board terminals (East Sensor, West Sensor, East Limit Switch, West Limit Switch, Motor and Power Supply)

The best approach for building your tracker is to mount the circuit board inside a waterproof enclosure and run wires to the photocells, limit switches, motor and

power supply. Water tight connections can be made with pure silicone sealant, or you can purchase a special wire feed thru connector such as seen in Figure 13.

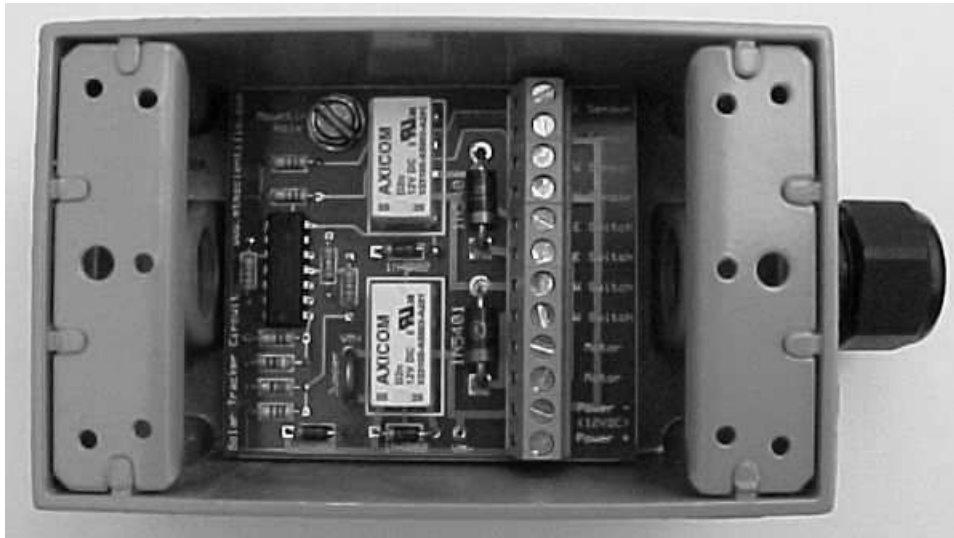

Figure 12. The Solar Tracker circuit board fits inside a standard outdoor box. Be sure to insulate the bottom of the board from making metallic contact.



Figure 13. Example of wires exiting the box using a feed thru connector. This NPT feed through connector is McMaster-Carr part number #7807K43.

Limit Switches

One very important feature of building the solar tracker is using limit switches, as shown in Figure 14. The purpose of the limit switches is to limit the mechanical motion of the tracker to a safe range. If the tracker moves too far in either direction a limit switch is actuated and stops the motion before damage.

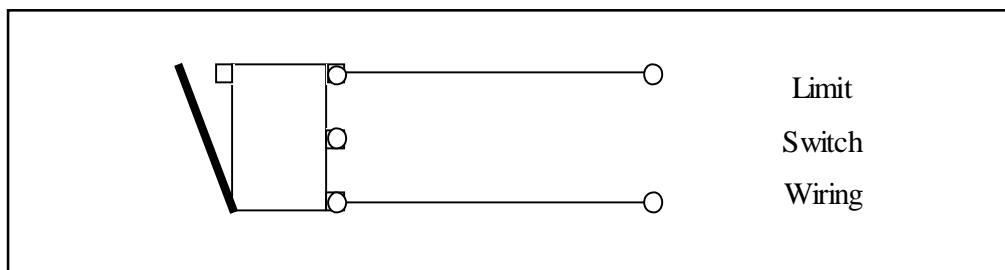
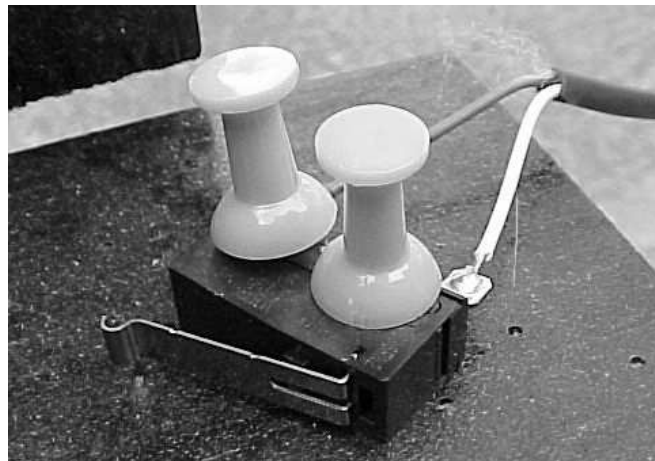

Figure 14. Limit switch and wiring. Switches are wired NC. (Normally Closed)

Normally, a tracker would need to be reset manually after tripping a limit switch, however the tracker circuit has provision for automatic reset. A diode is wired in parallel with each switch to allow movement *in the opposite direction* after a limit switch is actuated. The limit switch diodes are mounted directly on the circuit board, as shown in the circuit diagram.



The solar tracker circuit will track the sun during the day until the West limit switch is actuated. When it becomes dark the tracker will move to the East position until the other limit switch is actuated and then wait for dawn. Parking the tracker pointing to the East captures the first sunlight in the morning, and also has the advantage of moving the tracker with freshly charged batteries.

NOTE: During your initial trials with the tracker you may find the tracker motor is moving in the wrong direction. (Opposite to what you expect.) In this case you should change the motor polarity by swapping the 2 motor wires at the terminal block on the circuit board. This is why there are no polarity marks on the circuit board connector for the motor connection. The correct wiring connection depends on your motor and mechanical setup.

Motors & Drive Trains

The 12 VDC Motor for operating a single axis tracker should be chosen to have high torque at low RPM. This is most easily accomplished by using a special type motor known as a DC Gearhead Motor. Gearhead motors are built with an integral gear drive reduction mechanism which reduces the RPM and increases the torque. Figure 15 shows an example of a solar tracker mounted directly to the output shaft of a large DC Gearhead motor. Note that the “T” section shadow block for mounting the photocells is made of wood. A video of this solar tracker in action is available at the MTM Scientific website.

An AC power supply and AC motor can not be used with the MTM Solar Tracker Circuit. A DC motor reverses direction when the polarity of the power supply is reversed, but an AC does not reverse direction.

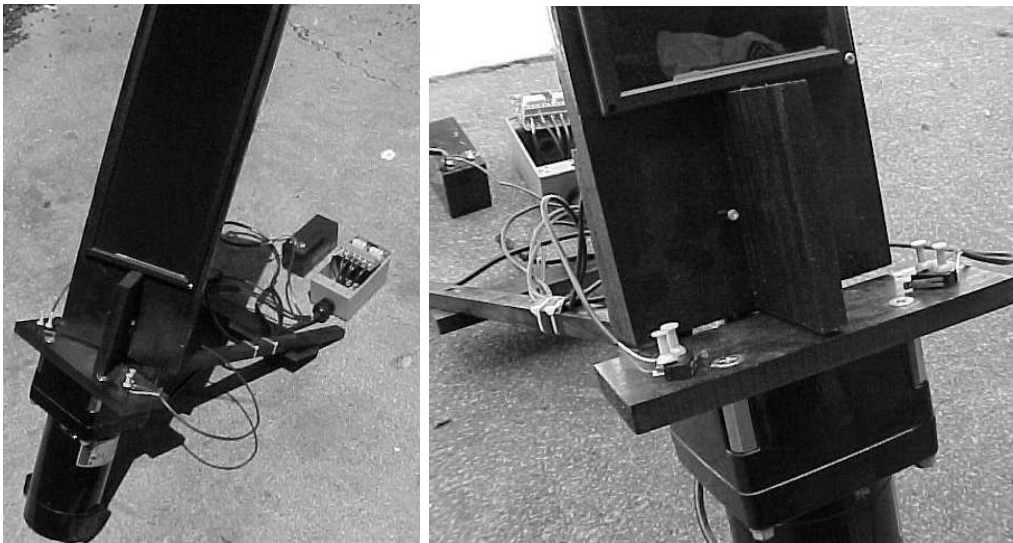
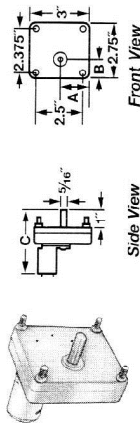

Figure 15. Prototype solar tracker mounted directly to a gear head motor.

In practical terms, it is almost impossible to find a DC motor that is too slow. Recall that the the motion of the sun is effectively one revolution per day. Figure 16 contains a few excerpts from supplier catalog pages with typical examples of motors that would work. A good source of inexpensive low RPM gear motors is Jameco Electronics (www.Jameco.com).

If you happen to already have (or find) a nice gear head motor rated for a voltage higher than 12 VDC, perhaps 24 VDC, chances are it will probably work just fine at the lower voltage... it will simply rotate slower. Actually, the motor shown in the example for Figure 15 was rated for service at 90 VDC, but it works just fine at 12 VDC and provides a very nice extra-slow movement.

Subfractional-hp DC Gearmotors



With less than 1/100 hp, these permanent magnet gearmotors are ideal for use in small spaces such as business machines, appliances, and valve actuators. A gearmotor consists of a motor and fan matched with a geared speed reducer to lessen speed while increasing torque. Shaft has a flat to accept set screws for easy connection to your equipment. Motors are brush style and have two terminals for electrical connection. Rotation is clockwise when facing the shaft end. To reverse rotation, switch the lead wires (follow the included wiring diagram). For speed controllers, see 729K on page 813. Housing is die cast zinc with bronze sleeve bearings. Gears are iron and Delrin. Motor face has four 10-32 threaded mounting studs.

rpm	Torque, in.-lbs.	(A)	(B)	(C)	Full Load Amps	Each
12 VDC						
6	50	1.43"	0.91"	3.45"	0.12	6409K11 \$41.64
13	50	1.43"	0.91"	3.65"	0.45	6409K12 41.64
4	40	1.43"	0.91"	3.45"	0.68	6409K13 38.19
8	40	1.43"	0.91"	4.17"	0.73	6409K14 38.19
12	40	1.43"	0.91"	3.65"	1.3	6409K15 38.19
16	25	1.43"	0.91"	3.65"	1.4	6409K16 34.02
25	20	1.43"	0.91"	3.65"	1.3	6409K17 34.02
50	10	2.33"	1.38"	3.65"	1.2	6409K18 34.02
24 VDC						
12	50	1.43"	0.91"	3.45"	0.14	6409K21 41.64
4	50	1.43"	0.91"	3.45"	0.38	6409K22 38.19
8	34	1.43"	0.91"	3.65"	0.45	6409K23 38.19
12	24	1.43"	0.91"	3.65"	0.42	6409K24 38.19
17	17	1.43"	0.91"	3.65"	0.45	6409K25 34.02
25	50	1.43"	0.91"	4.17"	1.08	6409K26 34.02
47	28	2.33"	1.37"	4.15"	1.08	6409K27 34.02

McMaster - Carr
www.mcmaster.com

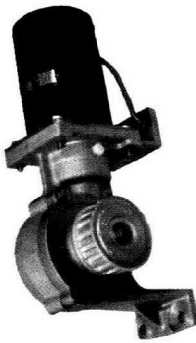

HEAVY DUTY DC MOTORS

USED Continuous duty, heavy duty reversible, DC gearhead motors. Rated: 30RPM @ 12VDC/5A No Load -10ft/lb stall torque, 54RPM @ 24VDC/10A No Load-20ft/lb stall torque, 128RPM @ 36VDC No Load-30ft/lb torque, 7/8" X 5/8" dia steel shaft with keyway, 2-3/4" dia. X 1-3/16" aluminum nub for Cog Belt, easily removable. Aluminum mounting base. 6" wire leads. Available with either Left hand or right hand output shaft (as viewed from motor)

STOCK #	DESC.	1EA	10-EA
14386-MD	Left Hand Motor	\$89.95	\$79.95
14387-MD	Right Hand Motor	\$89.95	\$79.95

WT: 18.2
L: 15" W: 6" H: 7-1/2"

24VDC 12RPM MOTOR



Crouzet 24VDC gear head motor. 12RPM @ 24VDC. 11mm X 6mm dia shaft with steel pin. 4" leads

STOCK #	DESC.	1EA	10-EA
14472-MD	24V 12RPM Motor	\$17.95	\$14.95

WT: .5
L: 4"(O/A) W: 2-3/4"(O/A)

Marlin Jones
www.mpja.com

15 RPM



GLOBE MOTORS, #299-A349-0007. 12 VDC gearhead permanent magnet motor. Reversible. sleeve bearings. No load speed 18 rpm @ 0.125 amp. With a 40 oz-in load the rpm is 15 @ 0.20 amp. Shaft: 3/16" dia. x 5/16" long. The shaft has a 1/4" long flat. Three tapped mounting holes are located on the face of the gearhead. The holes are tapped for #4X40 tpi screws. The bolt hole circle is approx. 1" dia. The motor has 18" long wire leads. Dimensions: 1-3/8" dia. x 2-13/16" long (excluding shaft).

Stock #DCGM9904 \$25.00

8 RPM MULTI

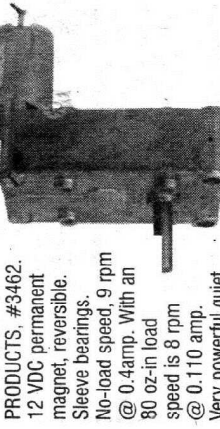

PRODUCTS, #3462. 12 VDC permanent magnet, reversible. Sleeve bearings. No-load speed, 9 rpm @ 0.4amp. With an 80 oz-in load speed is 8 rpm @ 0.110 amp. Very powerful quiet running motor. Shaft: 5/16" dia. x 1" long with flat running full length. Solder tabs for electrical connections. Four holes tapped #8X32 tpi on output face of the gearbox. The bolt hole centers are 1-9/16" apart in one direction and 1-5/8" apart in the other direction. Dimensions: 2-1/2" wide x 4" high x 3-1/4" deep (excluding shaft).

Stock #DCGM2101 \$22.50 ea. 5 for \$100.00

C&H Sales
www.candhsales.com

Design Tip: How to get the most from your DC Electric Motor.

A common question when building a Solar Tracker is “What size motor do I need for my tracker?” The answer to that question depends on: 1) The mechanical advantage of your drive train, 2) The amount of friction in the pivot points, and *most importantly* 3) The quality of balance in your mechanical setup.

Mechanical advantage is provided by the gearhead on your motor, and the additional gears and pulleys in the power train. The sun moves slowly and it is almost impossible to create a mechanical drive arrangement which is too slow. Timing belts and V-Belts are great ways to increase the mechanical advantage in your drive system. Mechanical advantage is gained when a small diameter pulley drives a large diameter pulley, as shown in the Figure 18. Increasing the mechanical advantage is less expensive than buying a larger motor.

Reducing the friction in your tracker drive system also has obvious advantages. Less friction means less resistance to motion. A great way to reduce the mechanical friction is by using free running ball bearing pivot points in your design. Nonmetallic plastic sleeve type bearings are another low friction option, especially if you limit the shaft size to the smallest practical diameter.

While mechanical advantage and friction reduction are important, achieving mechanical balance is also important, and the importance of this in your design is easy to overlook. Trackers should be designed to have good weight balance at all positions, as shown in Figure 17. This means the rig is stable and that you can place the rig in *any position* and it will not move from that position. A balanced tracker design allows the motor to work only against the friction...the motor is not

wasting power by lifting dead weight. Astronomers learned about the importance of balance a long time ago. Large telescopes are easy to move by hand because they are balanced.

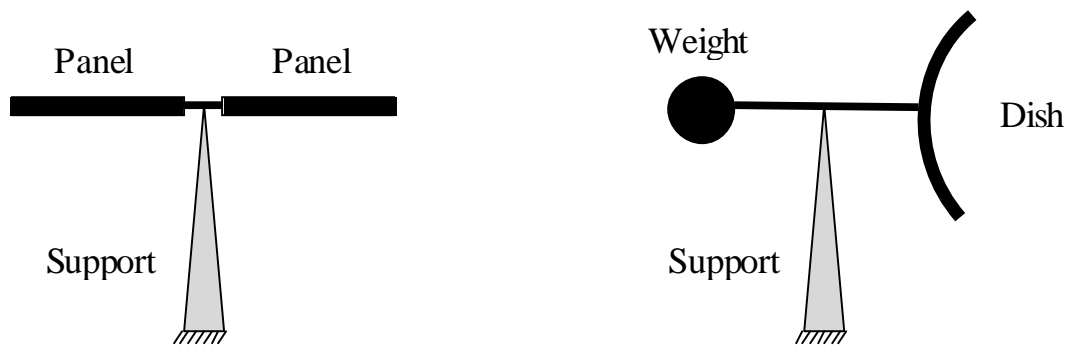

Figure 17. Design symmetry for balance reduces the motor size requirements. Adding weight to achieve balance is a viable design option.

The easiest way to achieve balance is by mounting your solar project's payload symmetrically. If your tracker project is not perfectly balanced, consider adding weight to improve the balance. You might consider this a surprising suggestion, but adding weight will substantially reduce the motor size requirements if the overall payload balance is being improved in the process.

Design Tip: How to maximize the service life of electrical relays.

The output of the solar tracker circuit is provided by dual electrical relays wired in a special configuration known as an H-Bridge. The H-Bridge configuration provides a complete polarity reversal, so the DC motor can move both forward and reverse. The relays can be used for millions of actuations, however their life can be substantially shortened or lengthened according to the way they are used in service.

A simple method to increase relay life is to reduce the number of actuations in a typical day. As simple as this sounds, this is an easy thing to overlook. For example, if your payload is a photovoltaic panel it is not necessary to be adjusting position every few minutes. An adjustment every 10 minutes is more than adequate and it will materially extend the relay's lifetime. Reduce the frequency of tracking adjustments in your design by simply making the shadow block shorter, or by using the computer controlled PICAXE version of the solar tracker circuit.

Powering a motor with relays is a challenging application because motors have an inductive component which tends to cause arcing during relay switching. Contact arcing is a major cause of shortened relay lifetime. Fortunately there is a simple technique to minimize arcing, and using the technique provides an additional unexpected benefit in your design. Relay contact arcing can be reduced by placing a small power resistor in parallel with the leads to the motor. The resistor will provide a path for the inductive currents that might otherwise cause contact arcing inside the relays. For a 12 VDC system consider using a 27 ohm power resistor rated for 5 watts, such as Jameco #660480. (A 24 VDC system could use a 100 ohm power resistor rated for 5 watts, such as Jameco #660623)

Adding a power resistor to snub the arcing has another advantage: The resistor will provide a path for the motor current to flow if something should attempt to dislodge your tracker, such as high wind or an imbalance caused by snow accumulation. The snub resistor provides a braking action that makes your tracker much less sensitive to external forces and therefore more stable overall.

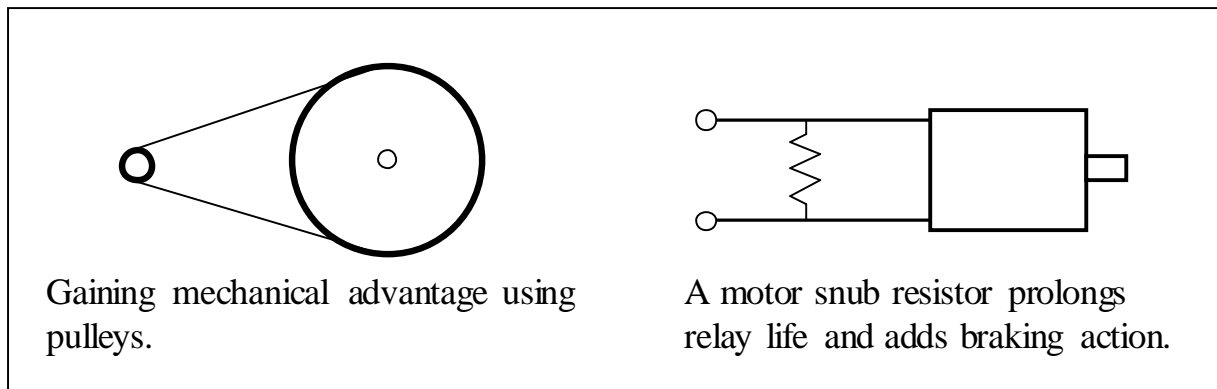

Figure 18. Use pulleys to gain mechanical advantage. Adding a motor snub resistor will prolong the life of the relays and add a modest braking action.

Mechanical Design Considerations

The mechanical drive between the motor and solar tracker can take many forms. As shown in Figure 15, our prototype solar tracker shadow block was directly mounted to the shaft of the DC Motor. This is a viable approach with low RPM motors and small devices, especially if you are want to get a quick start experimenting with the tracker circuit.

Larger devices will require a mechanical drive system between the motor and the tracker. Using a mechanical drive system makes it possible to incorporate a speed reduction feature into the drive system. For example, one effective drive system uses simple timing belt pulleys. The timing belt pulleys are notched, and mate with a cogged timing belt. A speed reduction occurs if the driving pulley is smaller than the driven pulley: The reduction is the ratio of their respective diameters. Figure 19 is a photograph of just such a drive reduction system using 0.20" pitch timing belt, often referred to as the XL series for "Extra Light". Components for building drives are available from Small Parts Inc (www.smallparts.com) and McMaster-Carr. Figure 20 shows a very simple belt drive system for moving a solar oven on a lazy susan type turntable.

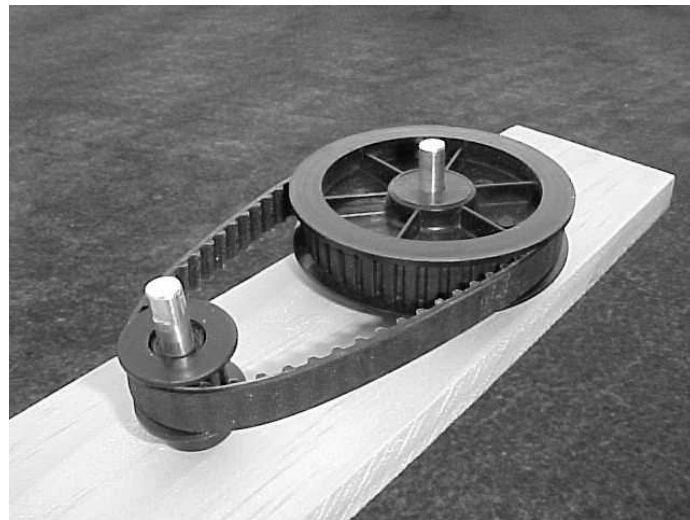

Figure 19. Example of a cogged timing belt mechanical drive system.

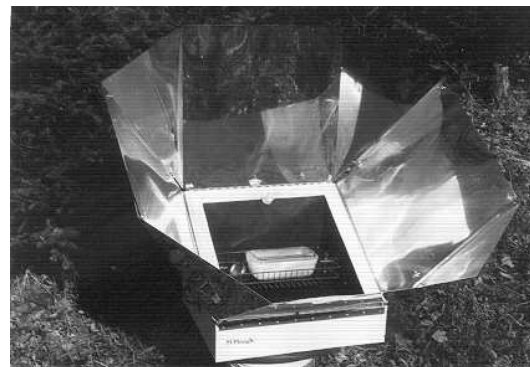
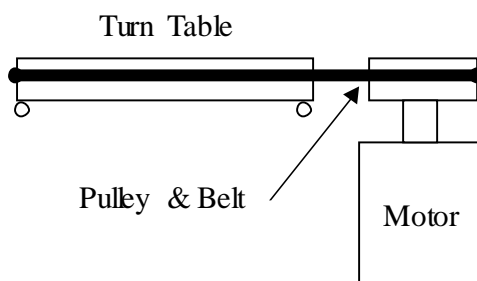

Figure 20. Turntable mounted solar oven for solar tracking

A DC Linear Actuator can be used instead of a DC motor to move the tracker. A simple mechanical arrangement is shown in Figure 21. Linear actuators can sometimes be found surplus on satellite dish movers, and some hobbyists even make their own homemade linear actuators. Figure 22 shows a linear actuator.

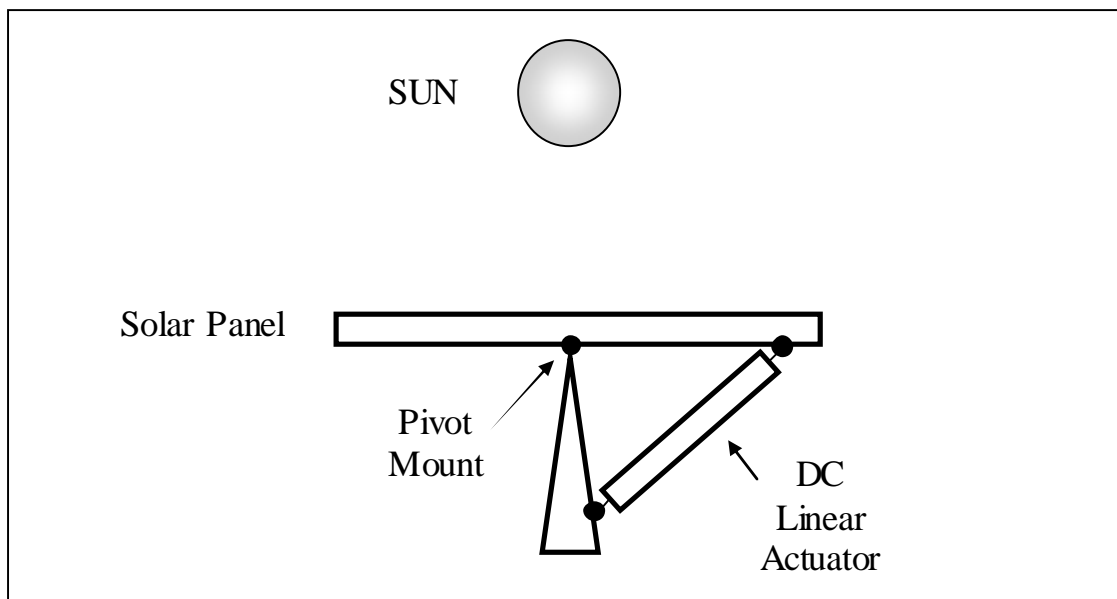

Figure 21. Simple mechanical arrangement for using a linear actuator.

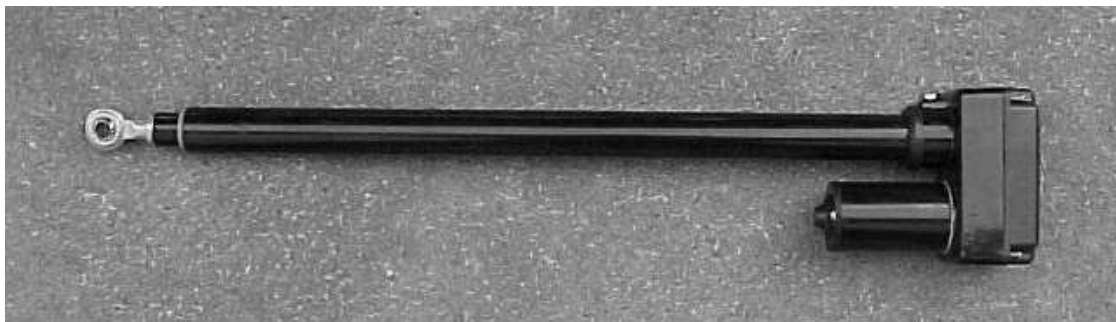

Figure 22. Example of a satellite dish linear DC actuator.

Bearings

Tracking the position of the sun involves moving mechanical hardware. The tracker must be designed to withstand the weather and the elements. The tracker must also be capable of controlled movement with low friction. Bearings are used to accommodate motion with low friction. There are many types and styles of bearings which can be used.

One simple, inexpensive and effective bearing type is the sleeved or flanged bearing, as shown in Figure 23. These simple bearings are useful for solar trackers because the loads and speeds involved for tracking the sun are low. These basic bearings are available in a variety of sizes, and will work with ordinary bolts used for the shafts as shown in the photos. The location of the bolt shafts can be secured by using vibration free nuts with nylon inserts. Typical construction materials for sleeve bearings are metallic (sintered bronze) or plastic (nylon). Both types are generally quite inexpensive.

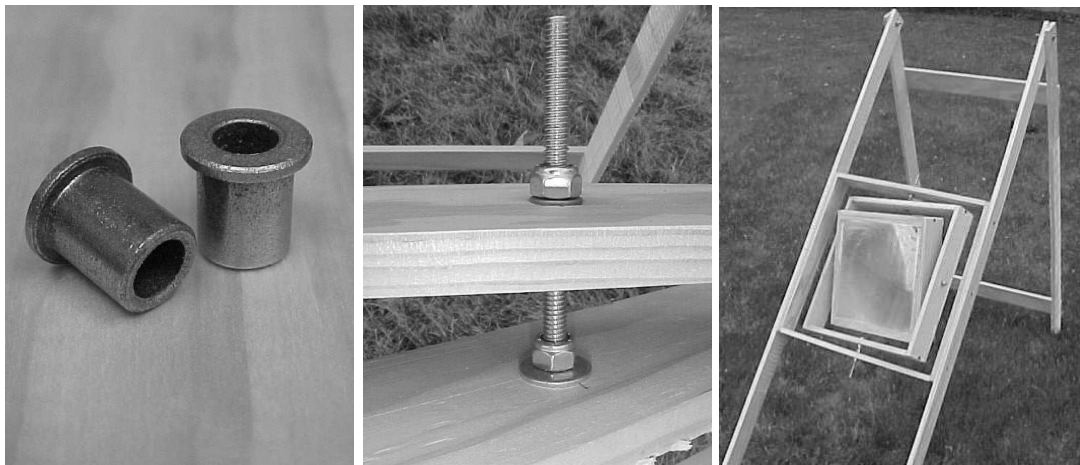

Figure 23. Flanged sleeve bearings used with a simple Fresnel Lens tracker.

Another common type of bearing is the ball bearing. Ball bearings can handle heavy loads and they provide very low friction. The basic outline of a ball bearing is shown in Figure 24. A simple ball bearing consists of an outer race, inner race, balls and ball spacer. The inner race is able to move with respect to the outer race by virtue of the intermediate balls. The balls “roll” along grooves in the surfaces of the races, hence the reason why this design has low friction.

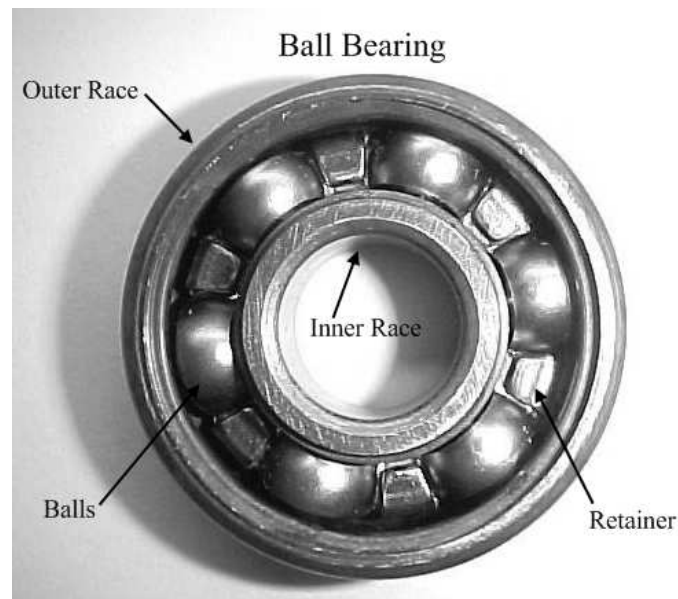

Figure 24. A typical Ball Bearing

Since the balls and bearing races are made of steel, they are subject to rust and corrosion from the weather. A typical solution to this problem is packing the bearings with grease, and sealing them. Fortunately, packed and sealed bearings are readily available, and are the most common type sold at hardware stores.

From a design perspective, the real challenge with using a ball bearing is attaching the mechanical elements of the tracker structure to the inner and outer races of the bearing. Fortunately, there are several design options available.

Probably the simplest method is to use a ball bearing already mounted in a housing called a ‘pillow block’ as shown in Figure 25. The pillow block holds the outer race of the bearing, and includes convenient mounting holes as part of the frame. Usually the pillow block also provides for some amount of angular adjustment, with a spherical cup-and-socket type mechanism integral to the assembly.



Figure 25. Ball Bearing mounted in a Pillow Block

Another simple method for using a ball bearing is to use a style known as a ‘flanged bearing’ as shown in Figure 26. In this case the bearing has been mounted in a flanged bracket, which also has convenient mounting holes as part of the frame. Usually the flanged bearing style also provides for some amount of angular adjustment with a spherical cup-and-socket mechanism.

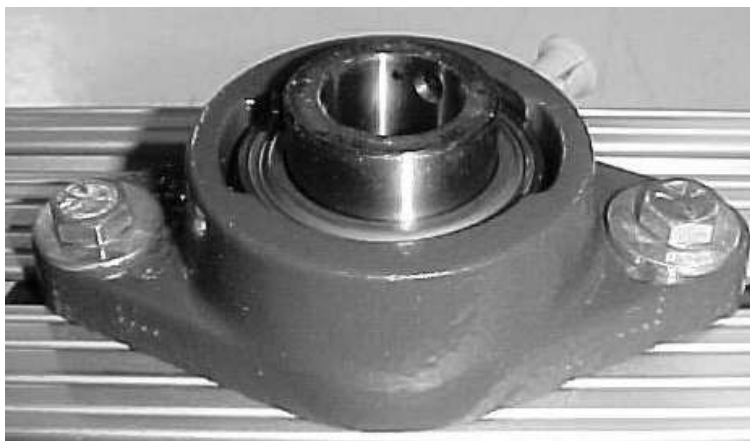

Figure 26. Ball Bearing mounted in a Flange



Ball bearings are design rated for a maximum load and a maximum RPM. Generally the ratings are not a design limit for solar trackers, therefore the most usual case is to use bearings that are conveniently available or fit the existing mechanical hardware (shaft sizes, etc.) Low cost, high capacity bearings mounted in pillow blocks or flanges are available online from such sources as EBAY and McMaster-Carr.

Dual Axis Sun Tracking

The same principle that is used for building a single axis solar tracker can be expanded to include building a two axis tracker. This is possible by building two tracker circuits and having one track East & West while the other circuit tracks North & South. With such a configuration, the tracker will actually find and follow the sun automatically, no matter where it is. In practice the annual variation in the sun's position along the second axis is slow enough that manual adjustment during the year is usually adequate for most applications.

Special Solar Tracker Kits from MTM

MTM Scientific produces the standard solar tracker kit (#ST2) and two other kits with special features. The #ST2HD is a heavy duty version of the kit with higher current capacity. The #ST2-HD-PIX is a computer chip controlled version of the heavy duty kit. Here are the design details and circuit diagrams for both of the additional kits.

Details of the Heavy Duty Solar Tracker Kit #ST2HD

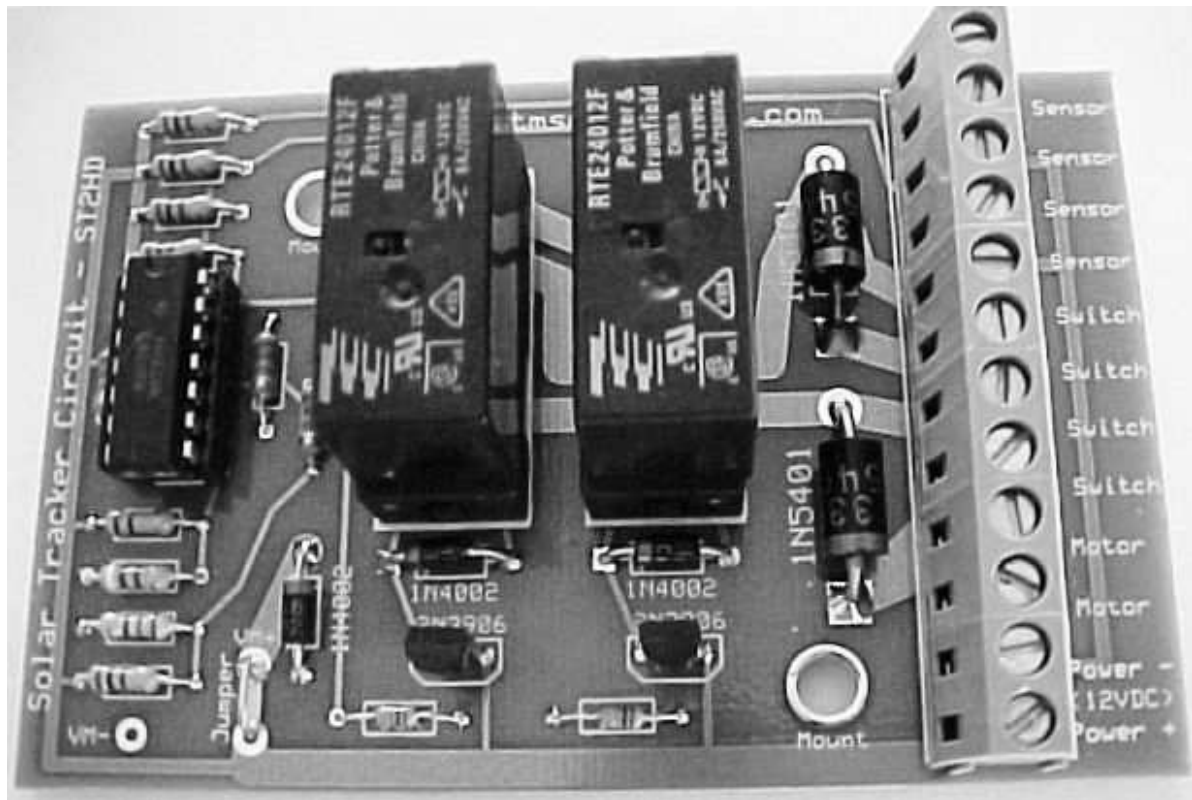

Figure 27. Heavy Duty Solar Tracker Kit

MTM Scientific Kit #ST2HD is a high current version of the standard solar tracker kit. This kit uses 2 heavy duty DPDT relays (TYCO Electronics #RTE24012F). The relays are rated for 8 Amps, with a 12 VDC coil and nominal 33 mA coil current. The limit switches supplied with this kit are also heavy duty and are rated for 10 Amps. (Omron #SS-10GL13T).

The heavy duty relays are not energized directly by the LM339 comparator as in the standard kit. Instead the relays are controlled by PNP transistors (#2N3906). The circuit diagram for the high current version is shown in Figure 28.



The relays are installed on the circuit board using relay sockets. The socketed relays allow for field replacement. The LM339 comparator is also socketed and can be replaced if necessary (Radio Shack #276-1712).

The circuit board for the Heavy Duty kit measures 2.5 inches x 3.8 inches. Two holes are provided for mounting the board. A fuse should be used with this circuit. Use the smallest size fuse that works for your application, but never more than 8 amps, which is the current rating of the relay contacts.

Aside from design component changes to make the unit capable of higher current, the actual function of the Heavy Duty Solar Tracker Kit is exactly identical to the standard Solar Tracker Kit (#ST2)

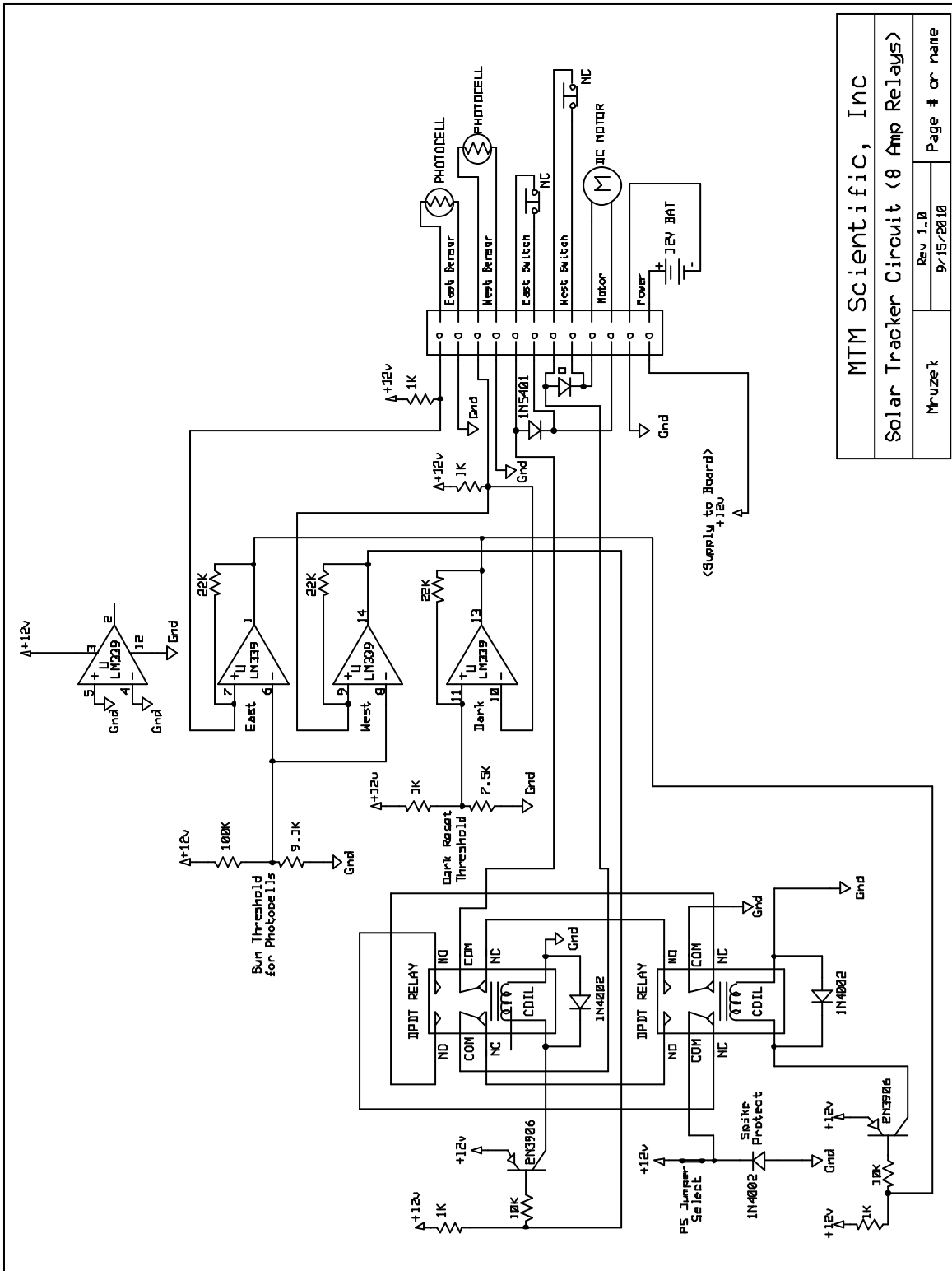

Figure 28. Circuit diagram of the Heavy Duty Solar Tracker from MTM

Design Details of the Computer Controlled Solar Tracker Kit #ST2-HD-PIX

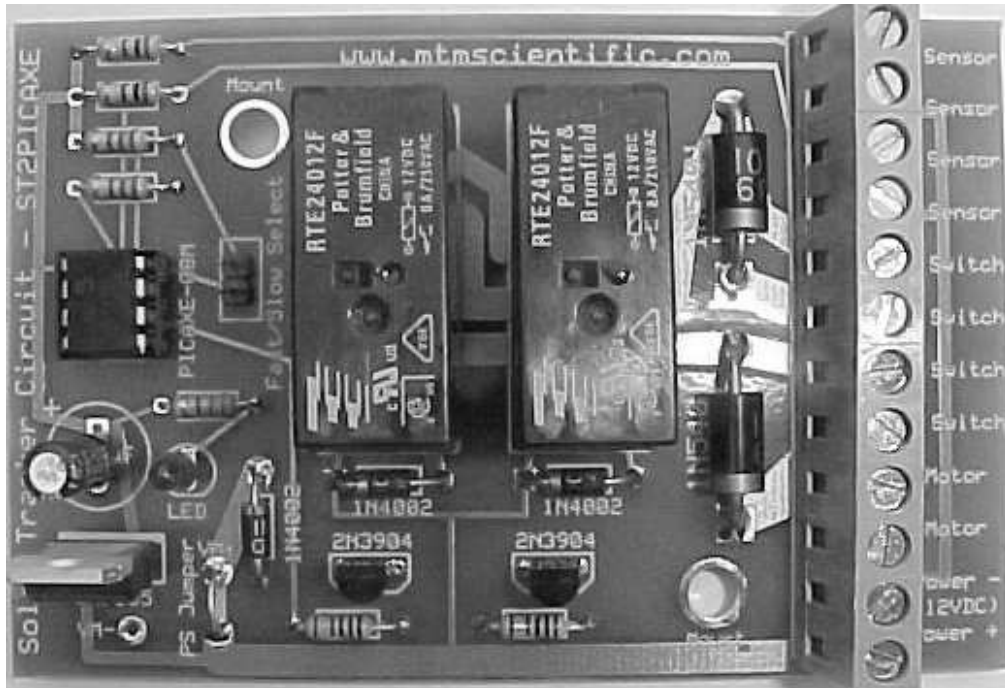

Figure 29. Computer Controlled Solar Tracker Kit

Kit #ST2-HD-PIX is a computer chip controlled high current version of our standard Solar Tracker Kit. This kit also uses 2 heavy duty DPDT relays (TYCO Electronics #RTE24012F). The relays are rated for 8 Amps, with a 12 VDC coil and nominal 33 mA coil current. The limit switches supplied with this kit are also heavy duty and are rated for 10 Amps. (Omron #SS-10GL13T).

The heavy duty relays are not energized directly by the IC chip as in our standard kit. Instead the relays are controlled by NPN transistors (#2N3904). The circuit diagram for the high current version is shown in Figure 30.



The relays are installed on the circuit board using relay sockets. The socketed relays allow for replacement. The controller chip is also socketed and can be replaced if necessary (PICAXE-08M programmed with a PICAXE Basic program). The circuit board for this kit measures 2.5 inches x 3.8 inches. Two holes are provided for mounting the board. A fuse should be used with this circuit. Use the smallest size fuse that works for your application, but never more than 8 amps.

The unique feature of this kit version is the PICAXE-08M computer control chip. The chip is programmed with a short computer program written in PICAXE Basic. The function of this kit is nearly identical to our other kits: the tracker will find and follow the sun, and the tracker will reset to the East at nightfall.

So what's different? The real difference in the action of this kit is the use of software timing control to limit the rate at which updates are made to the tracker position. ***The computer chip does not allow the tracker to update position more than once per minute.*** The advantage from a practical perspective is less wear and tear on your tracker's mechanical and electrical hardware. In addition, a special 'slow motion' setting is possible by installing the speed jumper on the circuit board, ***in which case the tracker will not update position more than once every 10 minutes.***

Since the tracker is computer controlled it was also possible to program a minimum 'ON' time for the motor: The tracker software was written to require a minimum adjustment time of 1/10th second. This feature gives the tracker motion a smoother mechanical action and prevents relay chattering.



The software program programmed into the controller chip is shown below. The program includes comments to make it easier to understand.

Advanced experimenters may be inclined to modify this program for their own purposes. Some ideas for advanced features would include: optimizing the light threshold settings automatically, changing the position update rate, adding data logging or using the clock to perform specific timing-based controls. Another idea would be to modify the basic circuit to use a more powerful version of the PICAXE Controller, for example the PICAXE-18X. In that case it would be possible to include real time serial communication, an LCD data display, additional A/D channels and many other useful features. Much more information about using and programming the PICAXE controller chips can be found at Phil Anderson's PICAXE website: <http://www.phanderson.com>

```
'This program controls a solar tracker relay H-Bridge using a PICAXE-08M
'All Rights Reserved 2011 by MTM Scientific, Inc.
'Output 0 and Output 1 are used to control the relays
'Input 2 (East) and Input 4 (West) monitor the photocells
'Input 3 monitors the slow/normal switch (0 or 1)
'Note that since Output 0 controls a relay, it is not available for serial com
'Install jumper on F/S Select to go Slow (Normal Speed =1 min updates =No Jumper)
symbol east = w0          'east is a 10 bit ADC number reading
symbol west = w1         'west is a 10 bit ADC number reading
symbol rate = b4         'rate variable 0=slow and 1=normal
symbol n = b5            'loop counter used for minutes
symbol sun = w3         'threshold for sun detect (Usually 186)
symbol dark = w4        'threshold for dark detect (Usually 1000)
    initialize all the pins for their respective functions
    output 0            'used for relay control
    low 0               'initialize low
    output 1           'used for relay control
    low 1               'initialize low
    input 2             'east photocell
    input 3             'slow/normal switch
    input 4             'west photocell
    sun = 186          'threshold adc reading for sunlight
    dark = 1000        'threshold adc reading for darkness
    pause 1000         'pause for 1 second to stabilize power supply, etc.
main:
    rate = pin3 logical 0 (slow) or 1 (normal)
    readadc10 2, east   '10 bit adc read east photocell
    readadc10 4, west   '10 bit adc read west photocell
    'Set first priority to move East or West as needed
    if east < sun and west > sun then goe
    if west < sun and east > sun then gow
    'Set second priority to park the tracker
```

```

if east > dark and west > dark then park
Set third priority to repeat the scan after a pause
pause 1000           'pause for 1 second
goto main           'repeat the sensor scan
'Note that no action was required for simply staying in place
goe: 'Routine for moving to the East
low 1               'strictly a blow-through preventing command
pause 100           'pause to prevent blow-through
high 0              'energize relay to move East
pause 100 'minimum ON time is 1/10 second
readadc10 2,east    '10 bit adc read east photocell
readadc10 4,west    '10 bit adc read west photocell
if east < sun and west > sun then goe
low 0               'stop energizing relay
if rate = 0 then slow
pause 60000         'normal fast update rate is 1 minute
goto main 'go to main loop after the normal delay
gow: 'Routine for moving to the West
low 0               'strictly a blow-through preventing command
pause 100           'pause to prevent blow-through
high 1              'energize relay
pause 100 'minimum ON time is 1/10 second
readadc10 2,east    '10 bit adc read east photocell
readadc10 4,west    '10 bit adc read west photocell
if west < sun and east > sun then gow
low 1               'stop energizing relay
if rate = 0 then slow
pause 60000         'normal fast update rate is 1 minute
goto main 'go to main loop after the normal delay
park: 'Routine for parking the tracker, double check signals first
'Parking initiation puts tracker in dedicated mode for 5 minutes!
pause 100 'slight delay and then double-check darkness
readadc10 2,east    '10 bit adc read east photocell
readadc10 4,west    '10 bit adc read west photocell
if east < dark or west < dark then main
'Double-checking completed, proceed with the parking mode
low 1               'strictly a blow-through preventing command
pause 100           'pause to prevent blow-through
high 0              'energize relay for move to the east
for n = 1 to 5      'allow 5 minutes for the parking motion
pause 60000         '1 minute delay in msec
'This routine exits the 5 min parking loop if bright light detected
readadc10 2,east    '10 bit adc read east photocell
readadc10 4,west    '10 bit adc read west photocell
if east < sun or west < sun then main
next n              'loop counter
low 0               'stop the parking action and wait for dawn
dawn: 'Start the wait for first light to start tracking again
readadc10 2,east    '10 bit adc read east photocell
readadc10 4,west    '10 bit adc read west photocell
if east < sun or west < sun then main
goto dawn 'continue looping while waiting for dawn
slow: 'Long time delay loop for extra-slow tracking.. (Jumper installed)
for n = 1 to 10     'minutes to wait for next move is 10
pause 60000         '1 minute delay in msec
next n              'next iteration
goto main 'go to main loop after the long delay

```

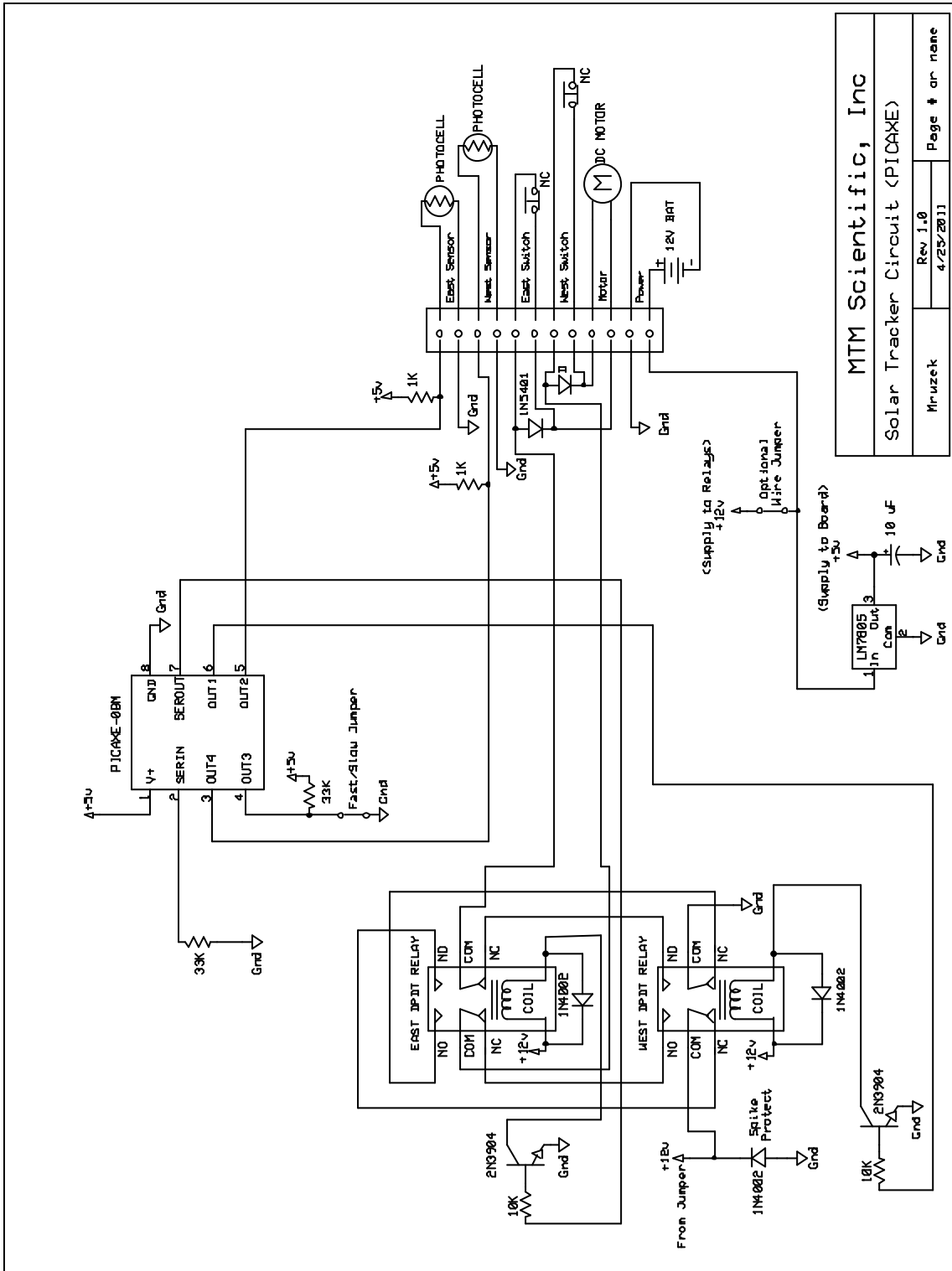

MTM Scientific, Inc	
Solar Tracker Circuit (PICAXE)	
Mruzek	Page # or name
Rev 1.0	4/25/2011

Figure 30. Circuit diagram of the PICAXE controlled Solar Tracker from MTM.

Solar Tracker Kit Construction: Frequently Asked Questions (FAQ's)

Here we have compiled a list of the most common questions we receive from hobbyists building the Solar Tracker Kits.

I applied power to the Solar Tracker Kit and smoke appeared. What's wrong? Can I fix it? Power was applied to the kit with reversed polarity (+ and -). The circuit cannot be fixed. You must order a new kit.

I'm bench testing my Solar Tracker Kit and the motor only moves one way (EAST)? Your kit is working properly. Remember that the circuit has a feature to reset your tracker to the East at the end of the day. The low light level on your bench has the circuit trying to do the reset to the East. Solution: Do the circuit testing in bright light, preferably OUTDOOR DAYLIGHT.

I'm bench testing my Solar Tracker Kit and I can hear the relay clicks, but the motor does not move? Your kit is working properly. For the motor to move the limit switches must be installed. The motor power path is through the normally closed limit switches. Solution: Install the limit switches, or jumper out the limit switch connections on your board.

I was testing my Solar Tracker kit and the LM339 comparator IC got hot and smoked? The comparator was damaged by either: 1) Static electricity, 2) A voltage surge from your power supply, or 3) Was installed backwards. Solution: Replace the comparator with a LM339 IC that's available at Radio Shack (#276-1712) for about \$2. Install the IC correctly, as shown in Figure 10.



I'm testing my Solar Tracker kit, but the motor is moving my tracker the wrong way? Your kit is working properly, but the East and West directions are reversed.

Solution: Reverse the wiring of the two leads to the DC motor.

Is there an easy way to increase the current output of the standard kit for a larger motor? No. Instead use the Heavy Duty Solar Tracker Kit (#ST2HD) which is rated for up to 8 amps.

My kit was working fine at first, but now I hear a whining sound and there is no movement? Check the voltage output of the battery you are using. It's likely the battery is discharged and needs to be replaced or recharged.

Kit Assembly Troubleshooting

We have sold hundreds of these kits for projects without problems. However, if you are having trouble with your project, here is a list of the most common problems we have encountered working with customers:

- 1) Forgetting to install the power supply jumper on the circuit board. (Refer to Figure 9.)
- 2) Solder Problems. Typically, incomplete solder joint connections or solder shorting between pins... especially in the critical area around the IC comparator socket. Do not use plumbing solder for electrical circuits... it has a corrosive flux.
- 3) Resistors placed in the wrong location, or diodes installed backwards. Use the artwork outlines on the circuit board as an assembly guide.
- 4) The Integrated Circuit Chip is installed backwards. (See Figure 10.) This is lethal to the IC. Purchase a replacement IC at Radio Shack (#276-1712).

5) A wire inserted into one of the screw terminal connectors is not making contact because of the insulation on the wire. *This problem happens surprisingly often, so look close!*

Payloads for Solar Tracking

Sunlight is a powerful but diffuse energy source. Useful applications of solar energy generally make arrangement for collecting sunlight over a large area. Flat panel hot plate collectors for heating domestic hot water and solar photovoltaic panels for generating electricity are two good examples. Flat plate style collectors do benefit from tracking the sun, however the accuracy of the pointing is not critical, and position adjustments made infrequently are often adequate.

Focusing solar collectors use optical methods to concentrate the sunlight. Consequently the accuracy of the pointing is more critical. The two major types of optical solar concentrators are reflective and transmissive.

A typical reflective solar collector is a parabolic dish. A parabola is a special mathematical curve which focuses the light to a single spot called the focal point. A simple circular curve can form a reasonable approximation of a focusing surface, and can be more easily constructed by experimenters. Figure 31 shows an example of a parabolic reflective curve. A parabolic focusing type collector must be aimed accurately in two directions, requiring a dual axis solar tracker. However it is also possible to build a trough type solar reflector collector using the parabolic curve, in which case a single axis tracker will suffice.

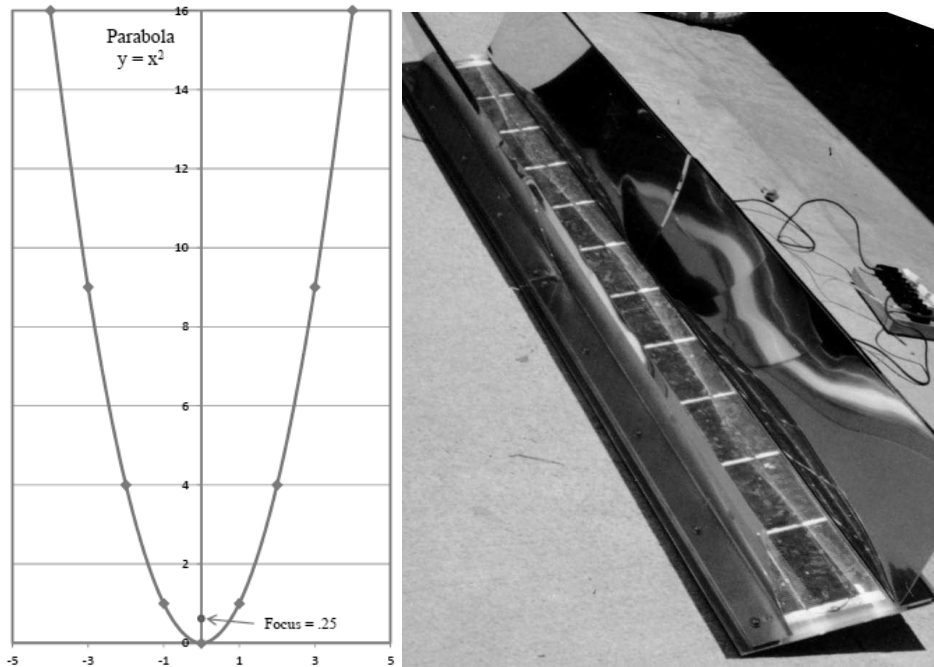

Figure 31. The parabolic curve and a linear trough collector example for photovoltaic cells.



Figure 32. Example of a spherical reflective collector built using cardboard and aluminum foil.

A typical example of a transmissive type solar concentrator is a glass lens. The lens focuses the light to a single spot, also called the focal point. Glass lenses tend

to be thick, heavy and expensive. A special type of focusing lens made of plastic is the Fresnel lens. The Fresnel lens is made of concentric grooved rings molded into a sheet of acrylic plastic. The method of manufacture results in a large thin lens that is fairly inexpensive. A normal Fresnel lens focuses to a point and must be aimed accurately in two directions, requiring a dual axis solar tracker. However it is also possible to construct a linear Fresnel lens which focuses the sunlight along a line, instead of a point. With a linear Fresnel lens the sun can be tracked using a single axis solar tracker, and the solar energy subsequently collected with a tube or pipe arrangement.

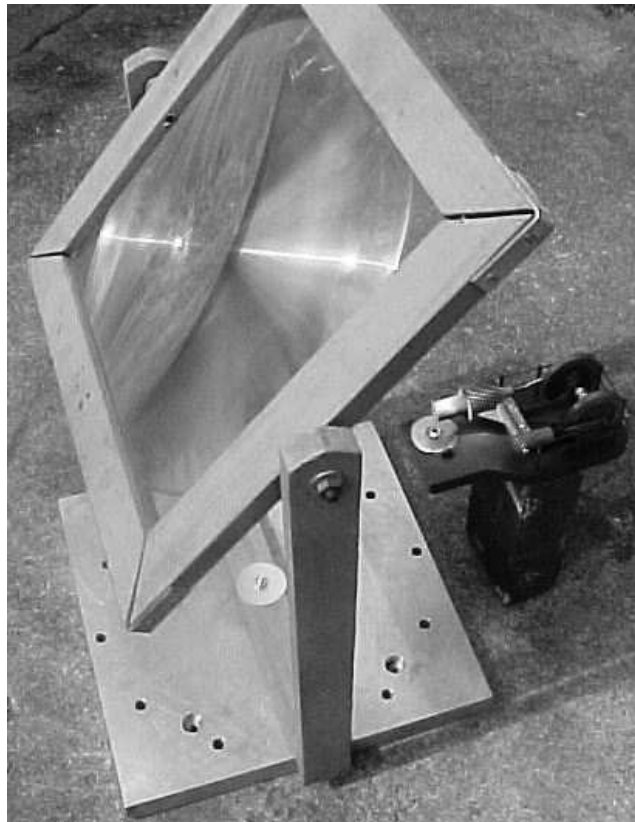

Figure 33. Fresnel lens powering a small air cycle stirling engine.

Examples of Solar Trackers

Our customers enjoy building things! Here are some photos of different solar tracker projects built by customers at MTM Scientific, Inc.

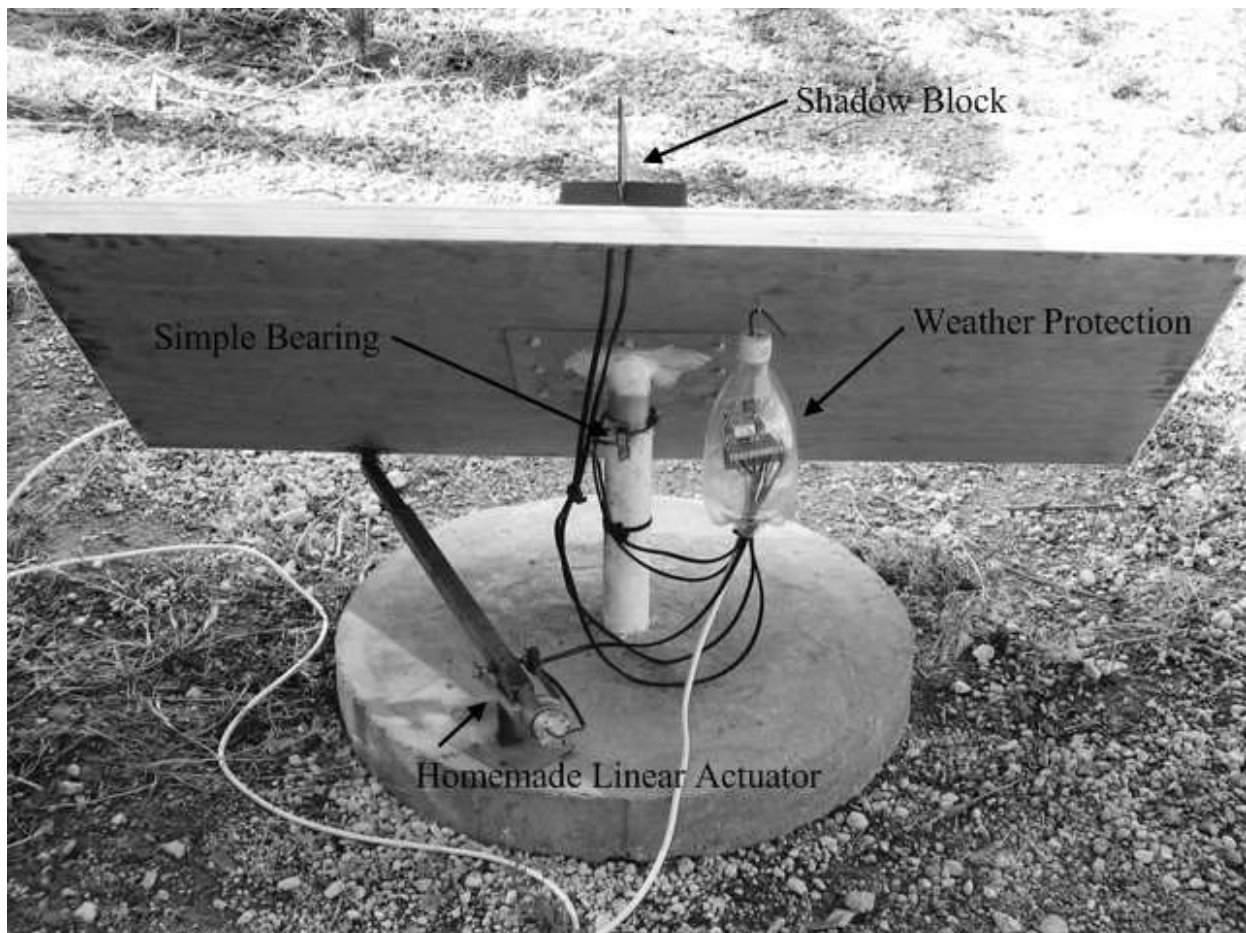

Figure 34. This Solar Tracker from Federico in Spain has several innovative ideas... Note the use of a simple rotary bearing, a plastic container for protecting the electronics, a patio tile forming a stable base and most interesting, a homemade linear actuator.



Figure 35. This Solar Tracker Project uses a DC linear actuator to move the panels. The controller is mounted inside a weatherproof electrical enclosure. The photos are courtesy of Bill F.

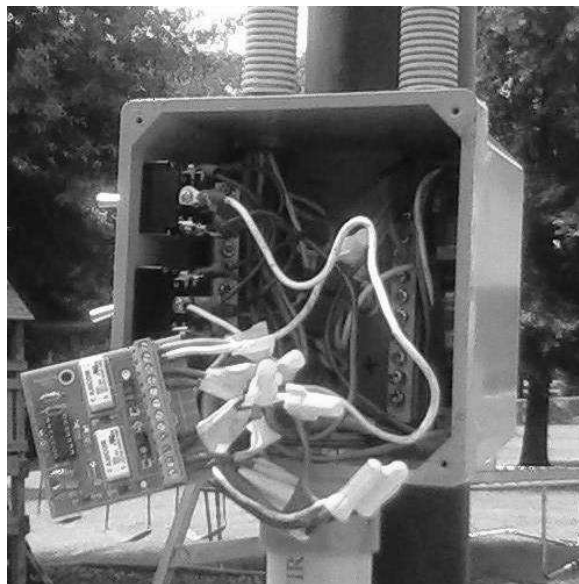

Figure 36. Here is a view of the enclosure for the electronics for the tracker shown in Figure 35.

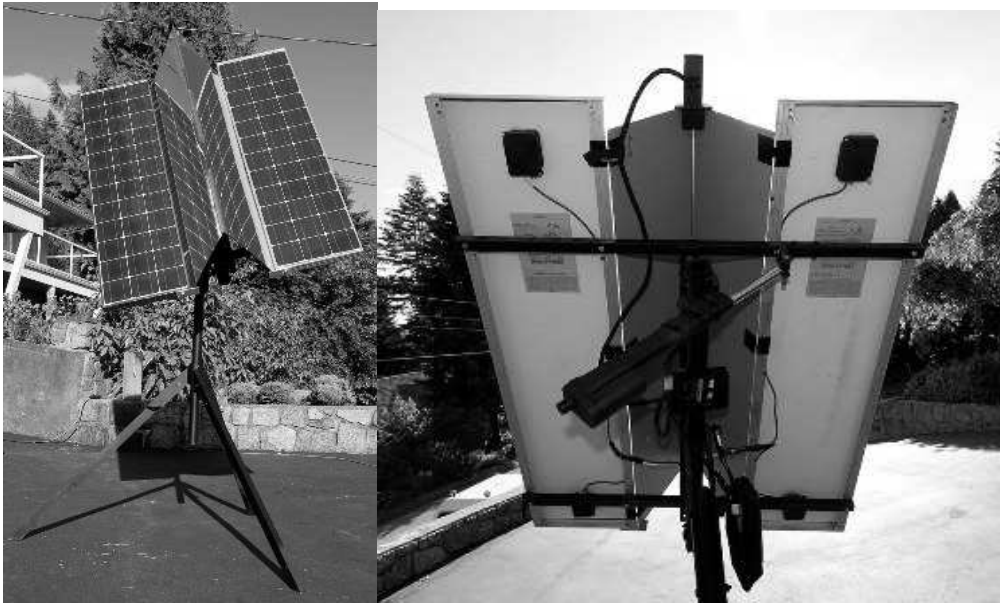

Figure 37. This awesome Solar Tracker project is the work of David. Note the use of a central mirror reflector to increase sunlight on the panels. These panels are moved with a heavy duty linear actuator.



Figure 38. Here is a view of the same tracker from Figure 33. Note the the shadow block assembly. Also, note how the circuit board was ruggedized with a conformal coating and is mounted in a weather tight enclosure.

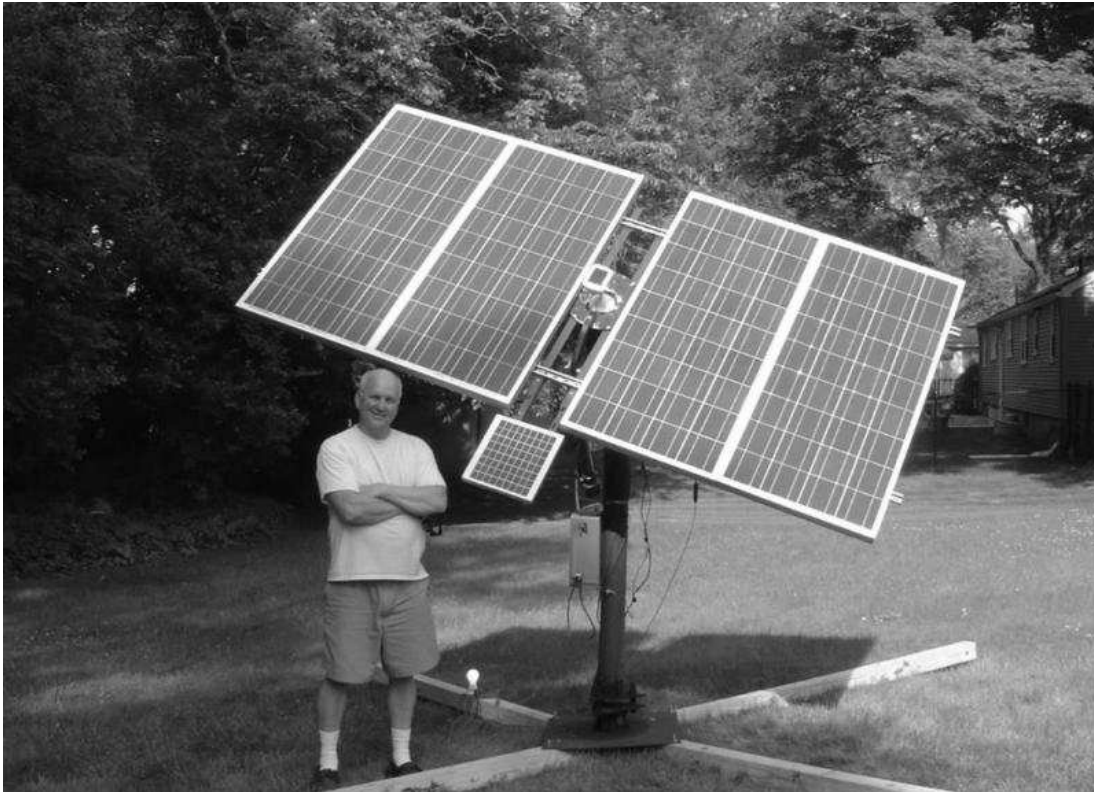

Figure 39. This Solar Tracker was built by Rich, who can be seen in the photograph. This extensive project is described in more detail at [EcoRenovator](#).



Figure 40. This Solar Tracker was built by Chuck in the Northeastern, U.S.A. Note the use of a linear DC actuator for the prime mover. The sun sensors are protected using an inverted test tube (photo insert).

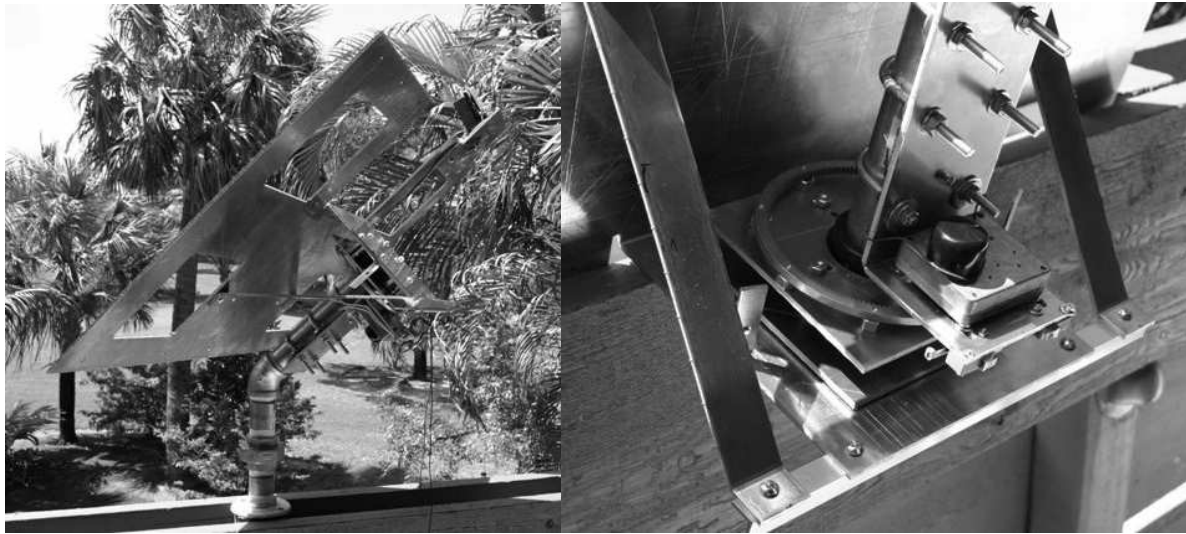

Figure 41. These 2 photos show the Solar Tracker built by J. Theismann. Note the fine workmanship on the mechanical details of the tracker assembly.



Figure 42. This Solar Tracker is the work of Dave in Australia. Note the use of a satellite dish type linear actuator for the prime mover and the efficient mechanical design.



Special Information for Solar Tracker Builders

For your convenience we have posted some of the photos contained in this report (in color) on a special private webpage on the MTM Scientific, Inc website. You can view the photos by typing the address shown below into your browser. Good luck with your project and happy experimenting!

<http://www.mtmscientific.com/solarpixs.html>

MTM Scientific, Inc.

Web: <http://www.mtmscientific.com> Email: mtm@mtmscientific.com